

Description

.High speed switching application.

Features

- High density cell design for low RDS(ON).
- Voltage controlled small signal switch
- High saturation current capability.

Ordering Information

Type NO.	Marking	Package Code
STK7000	STK7000	TO-92

Outline Dimensions unit :

mm

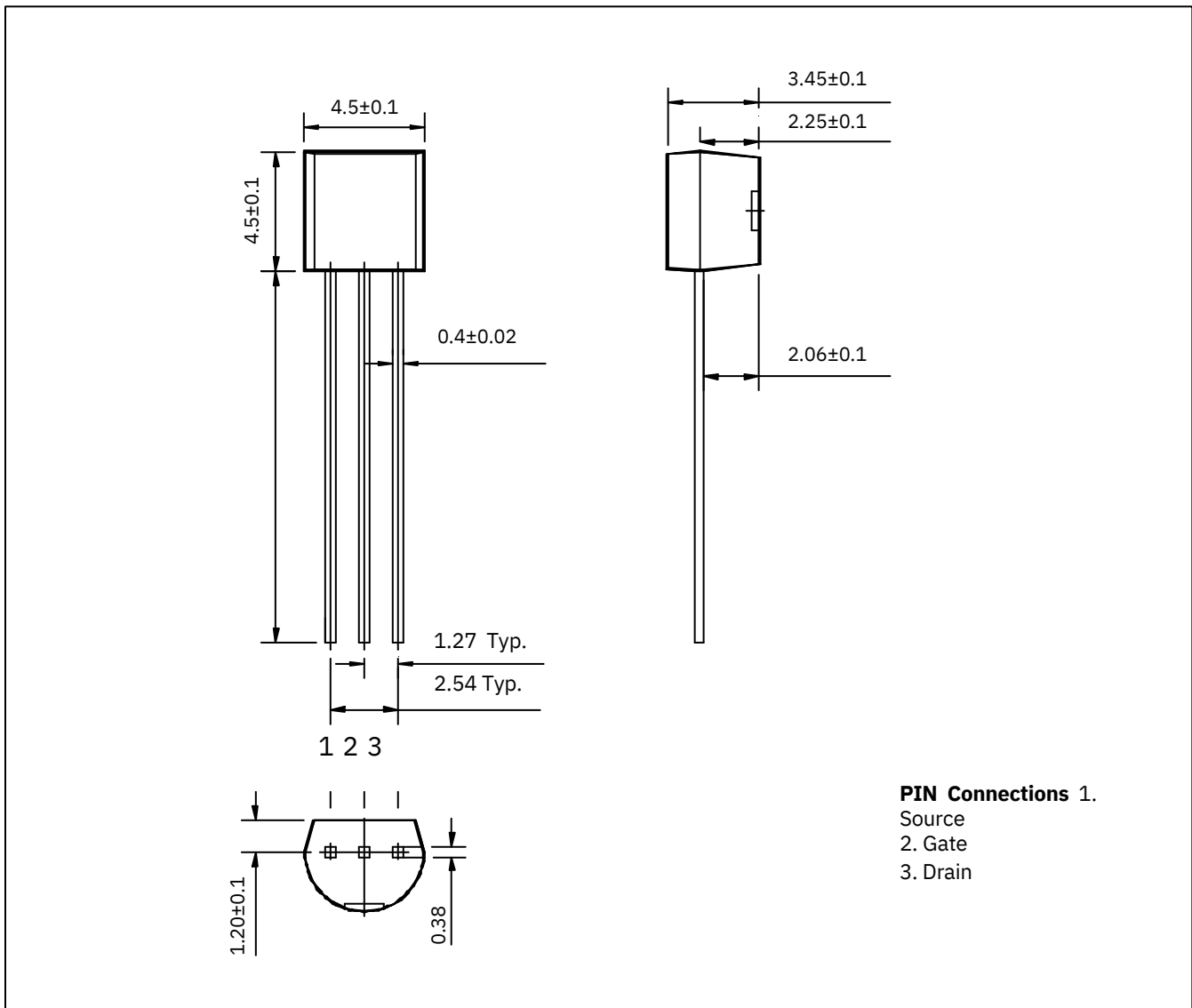

Absolute maximum ratings

(Ta=25°C)

Characteristic	Symbol	Ratings	Unit
Drain-Source voltage	V_{DSS}	60	V
Gate-Source voltage	V_{GS}	±20	V
Maximum Drain current	I_D	200	mA
Pulsed Drain Current	I_{DM}	500	mA
Power dissipation	P_D	400	mW
Maximum Junction-to-Ambient	R^{thJA}	312.5	°C/W
Operating Junction and Storage temperature range	T_J, T_{stg}	-55~150	°C

Electrical Characteristics

(Ta=25°C)

Characteristic	Symbol	Test Condition	Min.	Typ.	Max.	Unit
Drain-Source breakdown voltage	BV_{DSS}	$I_D=10A, V_{GS}=0$	60	-	-	V
Gate-Threshold voltage	$V_{GS(th)}$	I_D	0.8	2.1	3.0	V
Zero Gate voltage drain current	I_{DSS}	$D=1mA, V_{DS}=V_{GS}$	-	-	1	μA
Gate-body leakage	I_{GSS}	$V_{DS}=48V, V_{GS}=0$	-	-	±100	nA
On-state drain current *	$I_{D(on)}$	$V_{DS}=10V, V_{GS}=4.5V$	75	350	-	mA
Drain-Source on-resistance *	$R_{DS(ON)}$	$V_{DS}=0V, V_{GS}=±15V$	-	4.5	5.3	Ω
Drain-Source on-resistance *	$R_{DS(ON)}$	$V_{DS}=10V, V_{GS}=4.5V$	-	2.4	5.0	Ω
Forward transconductance *	g_{fs}	$V_{GS}=4.5V, I_D=0.075A$	100	-	-	mS
Input capacitance	C_{iss}	$V_{DS}=10V, I_D=0.5A$	-	22	60	pF
Output capacitance	C_{oss}	$V_{GS}=10V, I_D=0.5A$	-	11	25	pF
Reverse Transfer capacitance	C_{rss}	T	-	2	5	pF
Turn-on time	t_{ON}	$J=125°C$	-	-	10	ns
Turn-off time	t_{OFF}	$V_{DS}=10V, I_D=0.2A$	-	-	10	ns

*. Pulse test : Pulse width ≤ 300us, Duty cycle ≤ 2.0%

$V_{DS}=25V, V_{GS}=0, f=1MHz$

$V_{DS}=25V, V_{GS}=0, f=1MHz$

$V_{DS}=25V, V_{GS}=0, f=1MHz$

$V_{DD}=15V, I_D=0.5A$

$V_{GEN}=10V, R_G=25Ω$

$V_{DD}=15V, I_D=0.5A$

$V_{GEN}=10V, R_G=25Ω$

Electrical Characteristic Curves

Fig. 1 $I_D - V_{DS}$

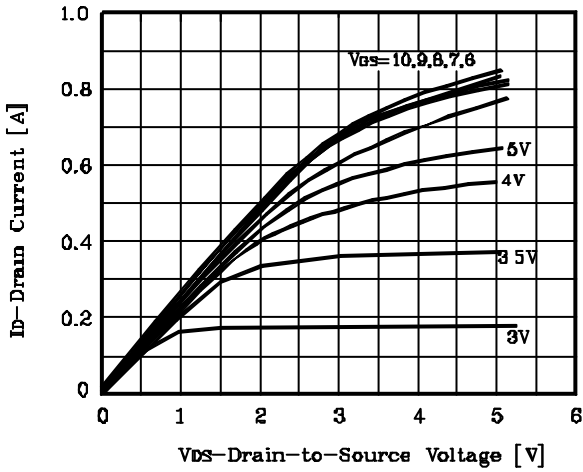

Fig. 2 $I_D - V_{GS}$

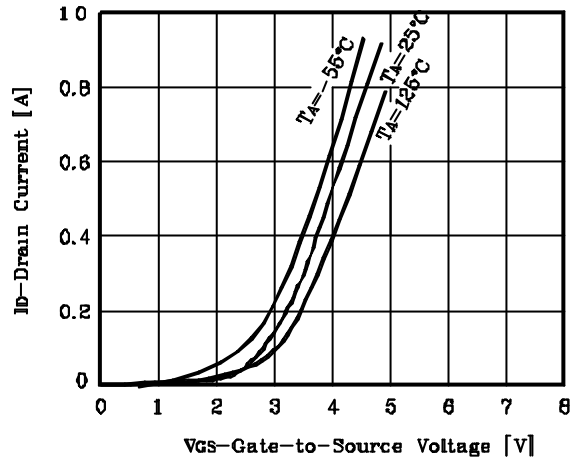

Fig. 3 $R_{DS(on)} - I_D$

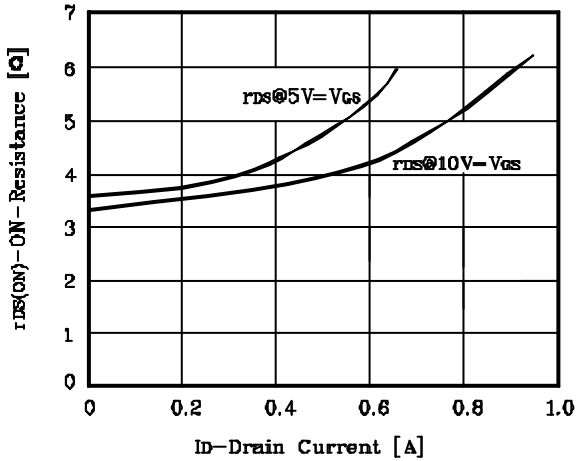

Fig. 4 C - V_{DS}

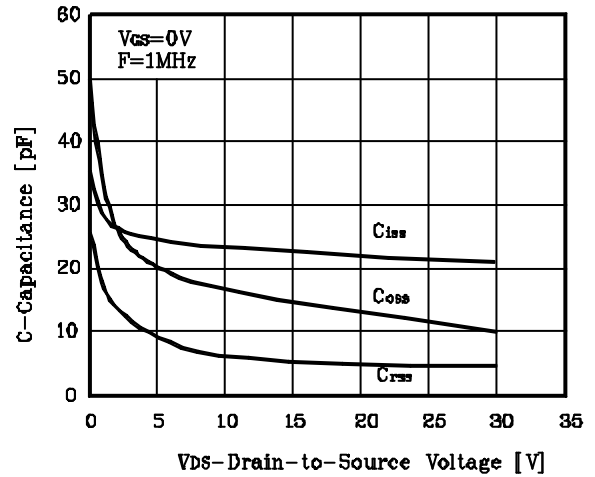

Fig. 5 $V_{GS} - Q_g$

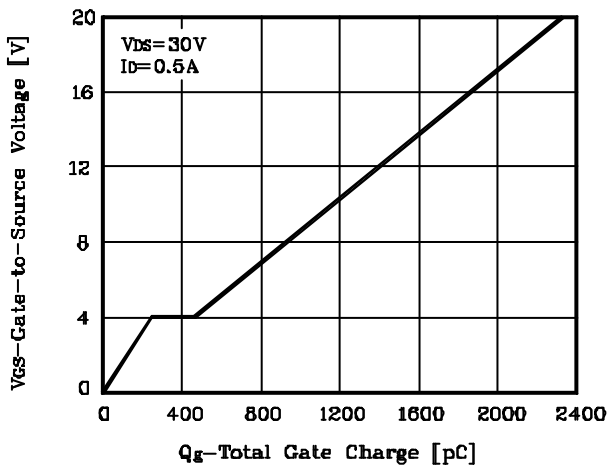

Fig. 6 $R_{DS(on)} - T_J$

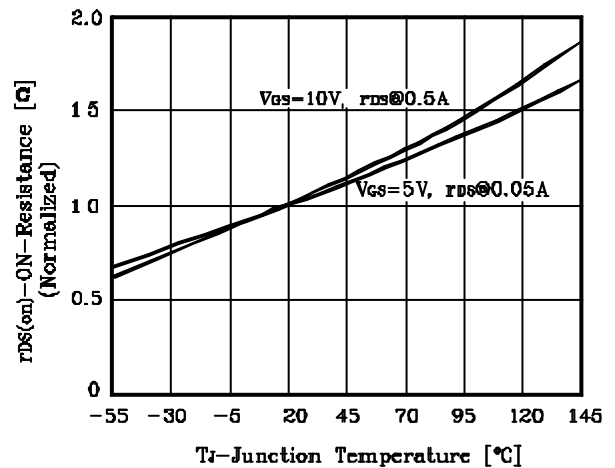

Fig. 7 $R_{DS(on)} - V_{GS}$

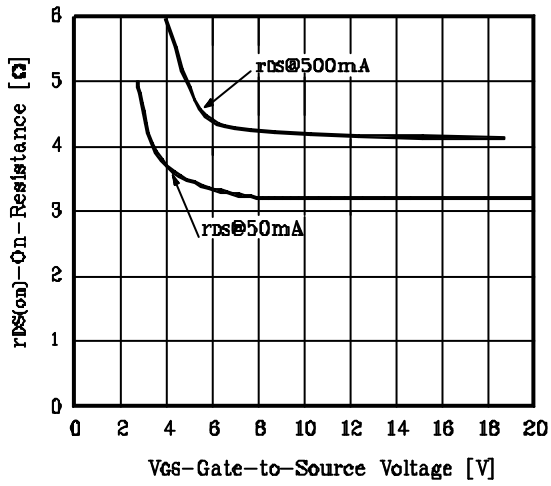

Fig. 8 $I_S - V_{SD}$

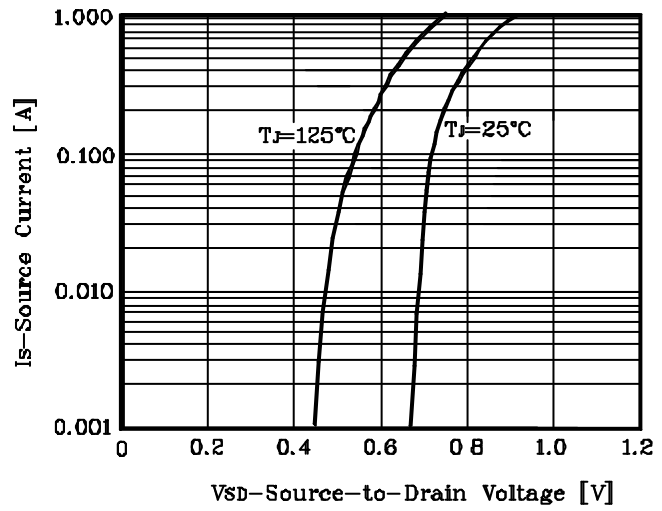

Fig. 9 $V_{GS(th)} - T_J$

