

XTW-SY-8

XL6003 Boost regulator

Features

Claimed specification

- Input voltage: 3.5-32V
- Output voltage: 5-35V, adjustable
- Size: 43,8mm x 21mm x 14mm
- Max. output current: 2.5A

Additional information

- 8 - 30mA idle current
- Sometimes exceeds the adjusted voltage
- The input current is limited to 2.5A, output doesn't come close to 2.5A

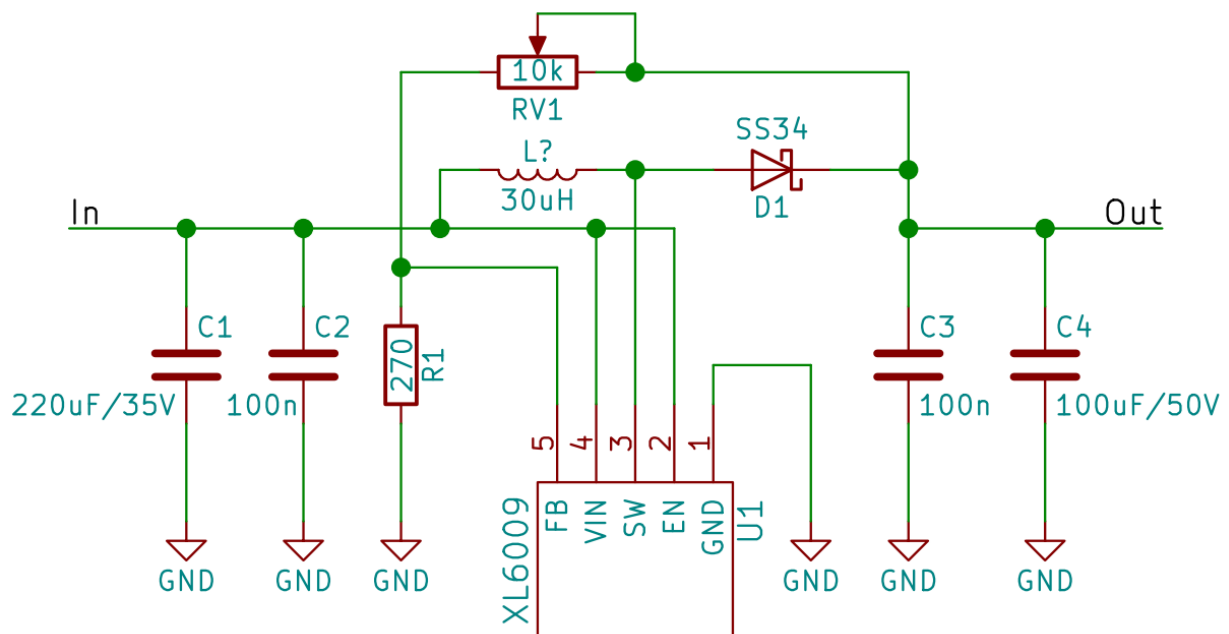
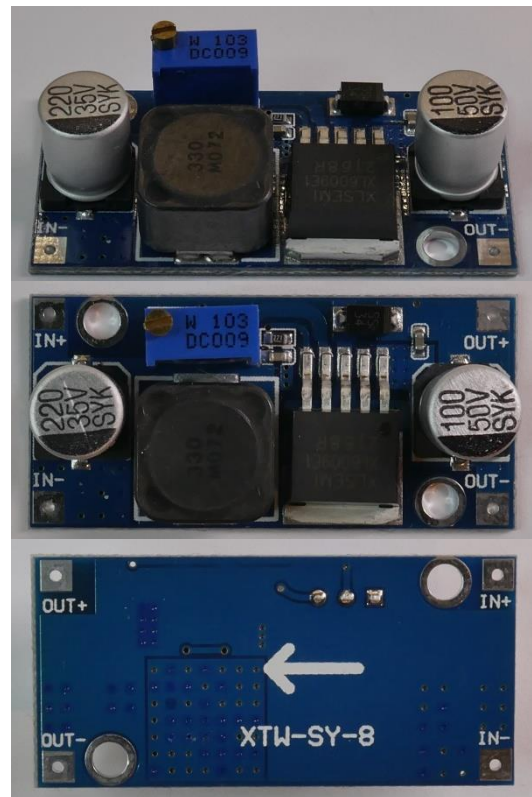

XTW-SY-8

XL6003 Boost regulator

5V Output

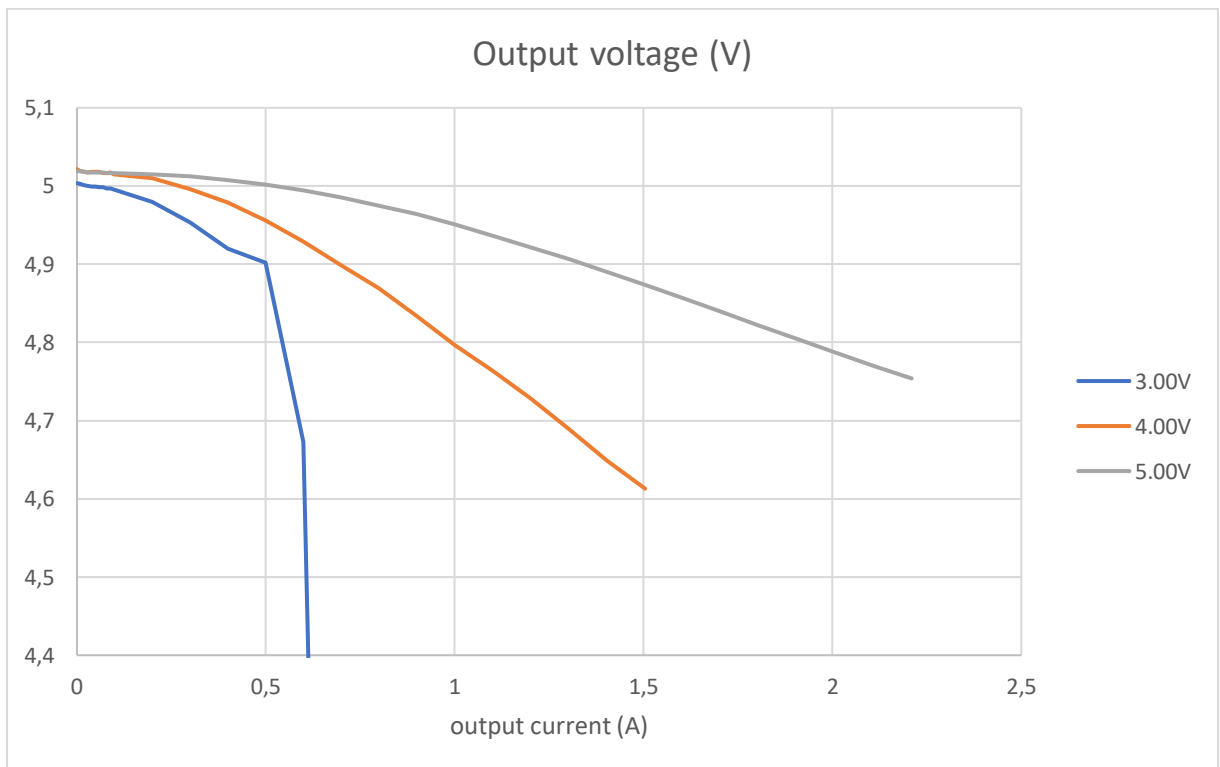
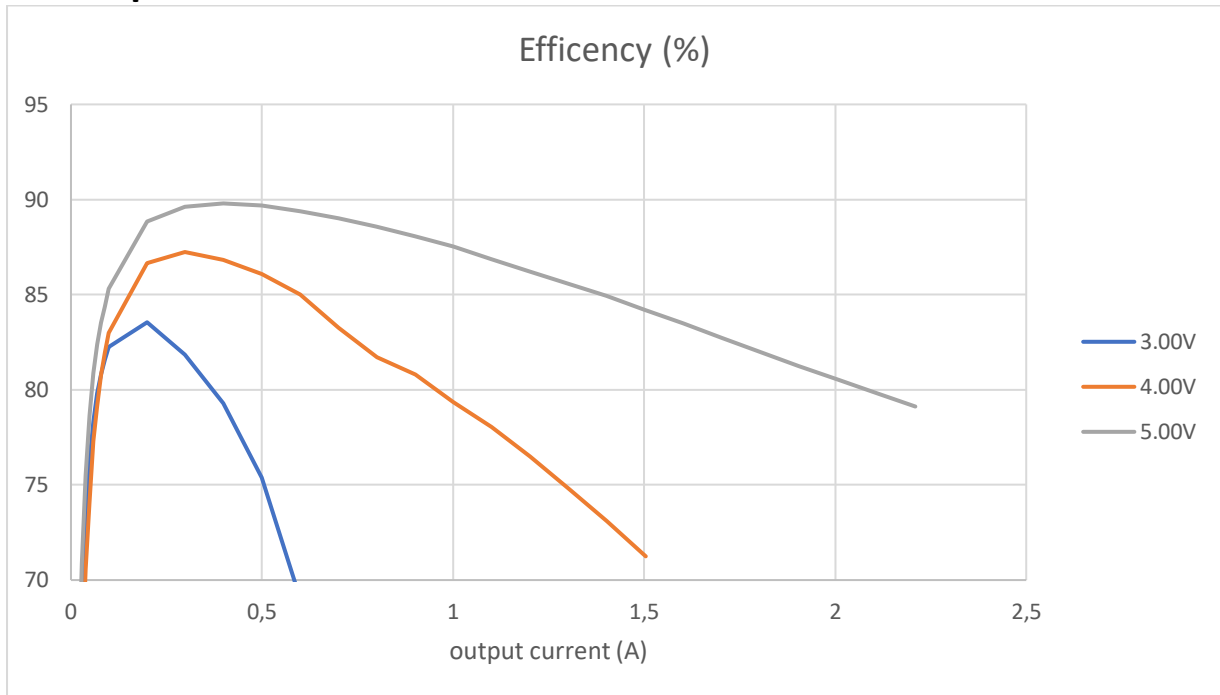

XTW-SY-8

XL6003 Boost regulator

9V Output

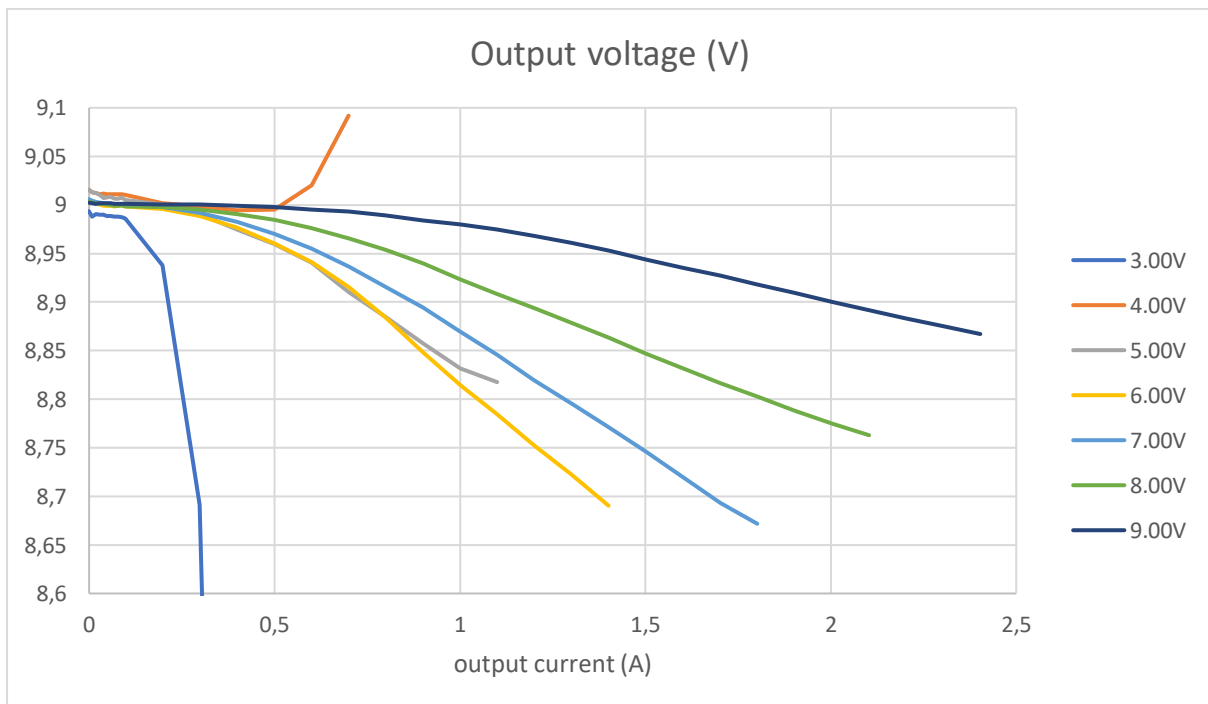
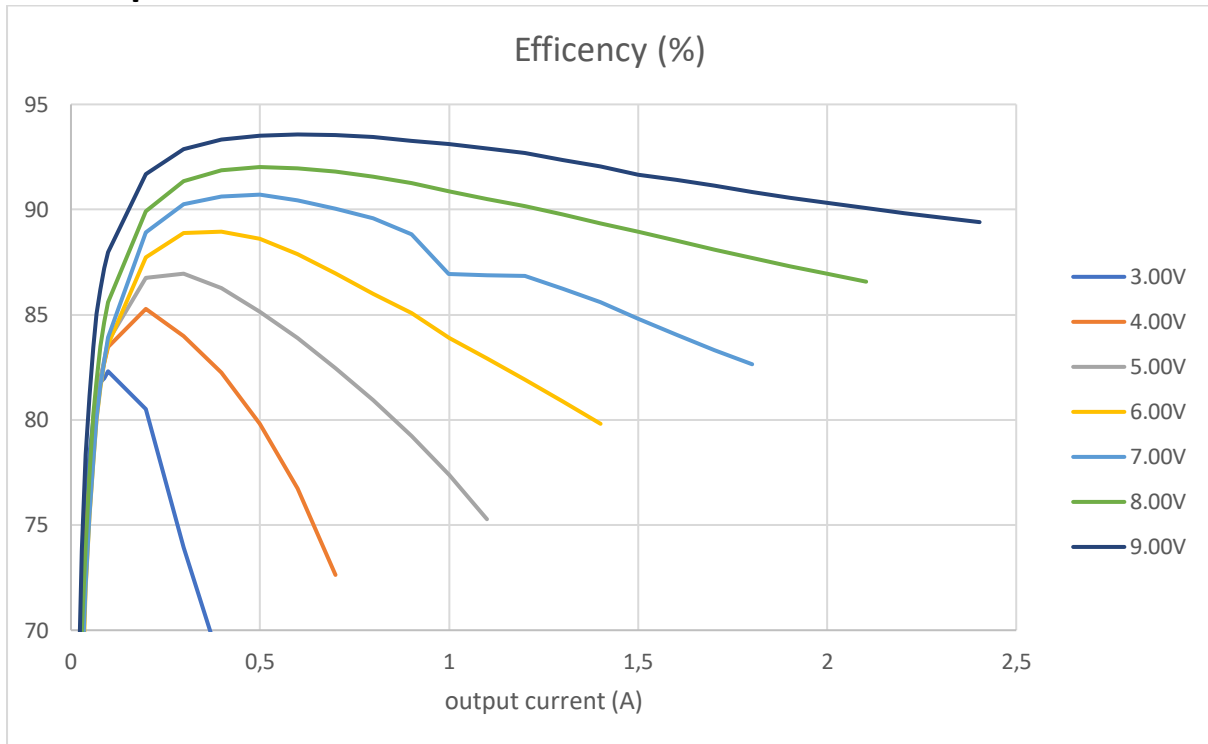

XTW-SY-8

XL6003 Boost regulator

12V Output

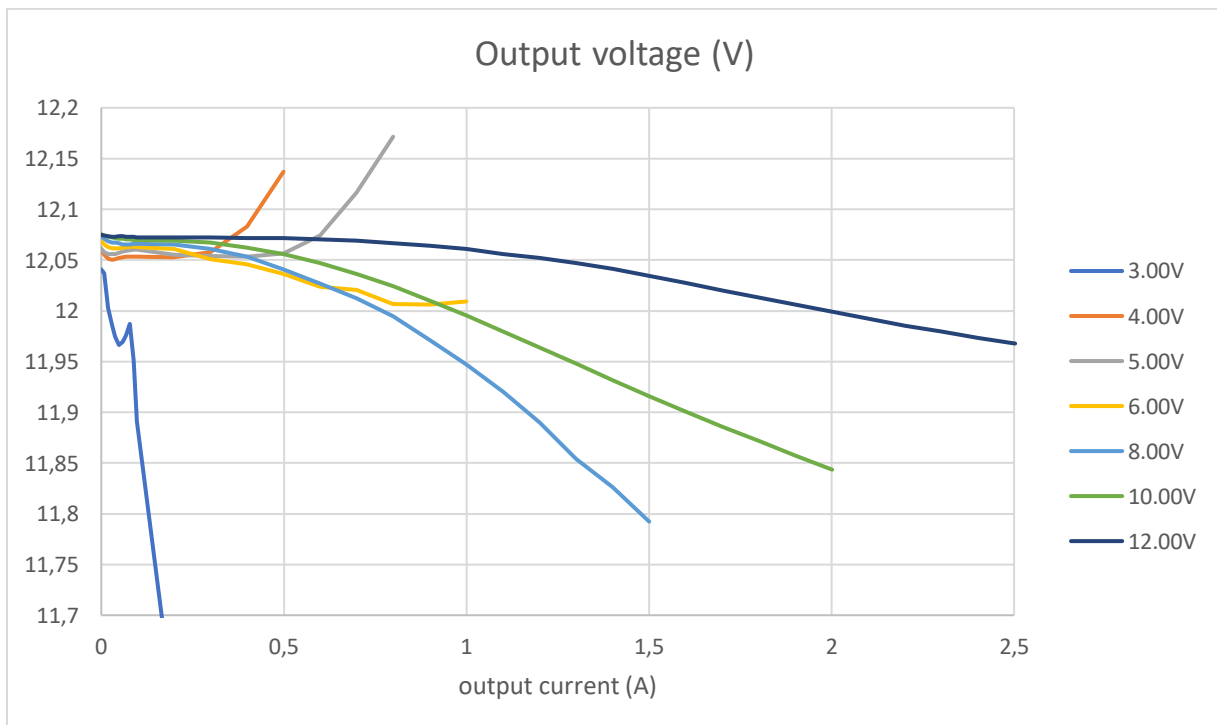
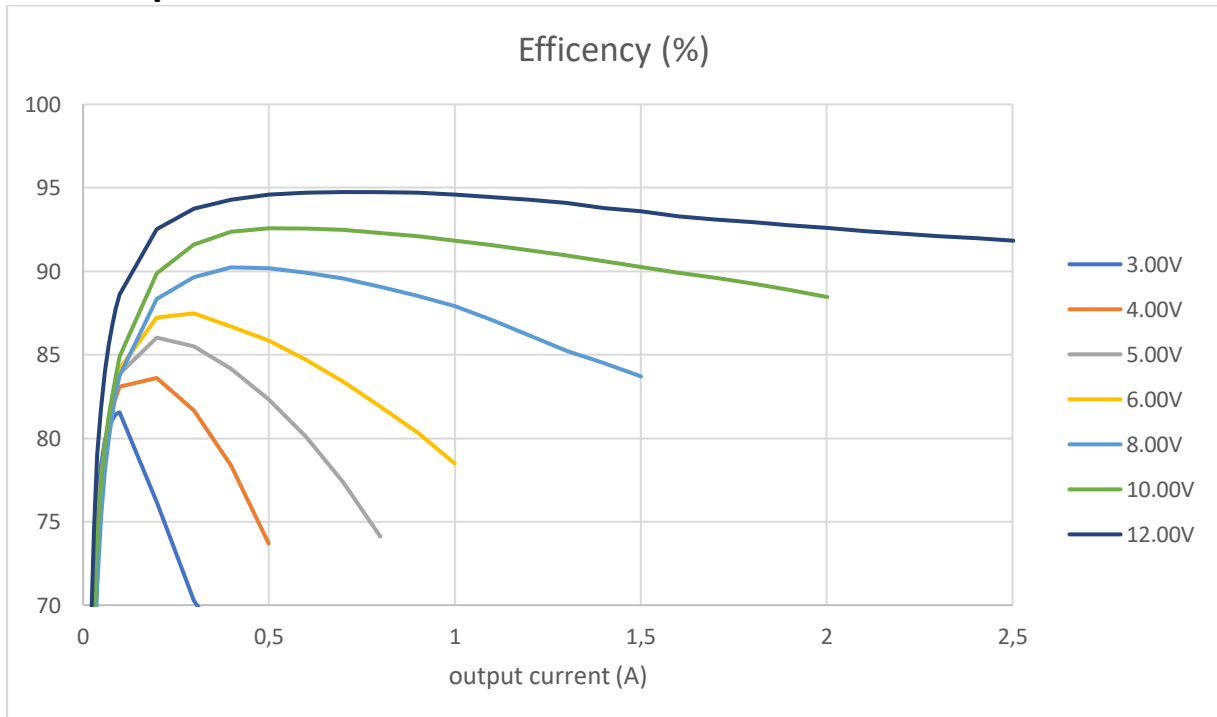

XTW-SY-8

XL6003 Boost regulator

15V Output

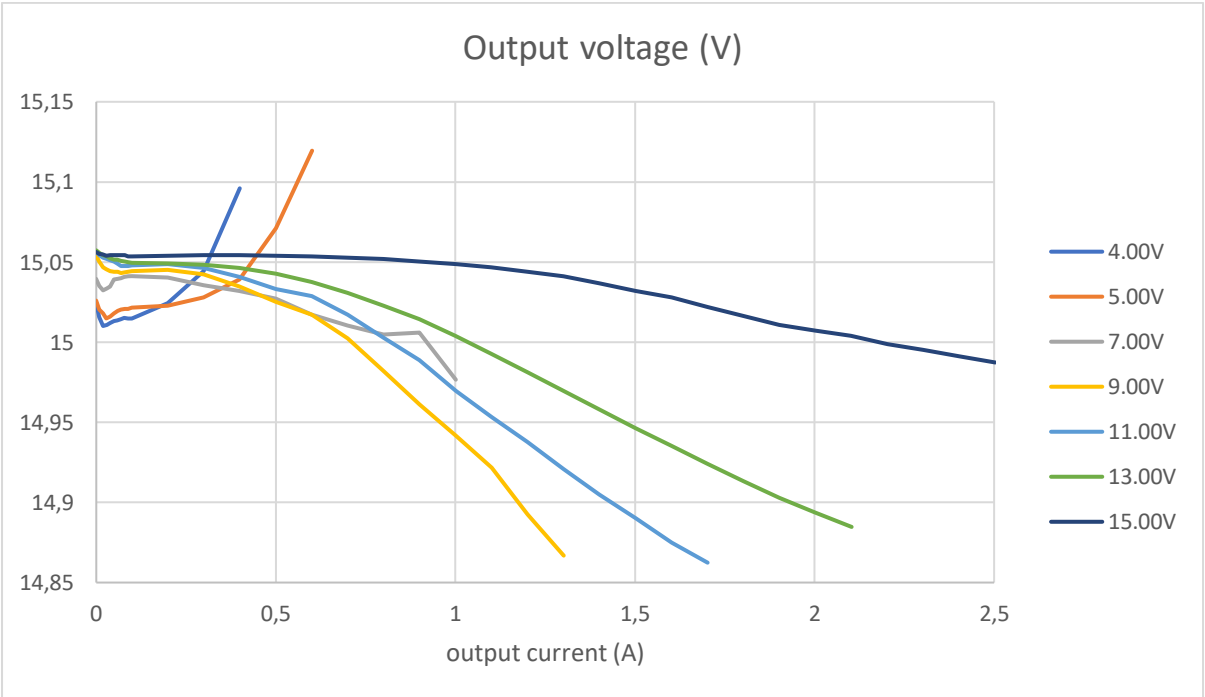
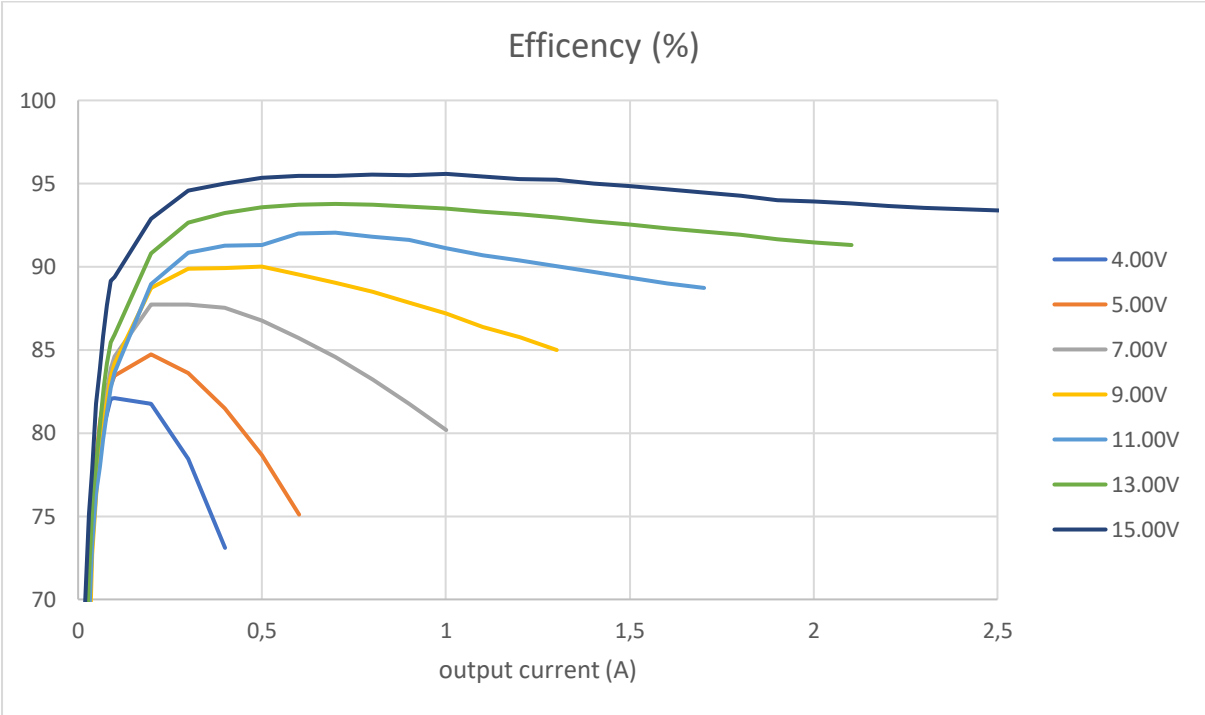

XTW-SY-8

XL6003 Boost regulator

20V Output

