D Subminiature Connectors



The ITT Cannon D Subminiature family of connectors has grown to include a wide variety of styles, options and accessories and is often the most economical solution to any interconnect problem. Ideally suited for both commercial/industrial applications and military/aerospace applications, ITT Cannon D Subminiature connectors have found worldwide acceptance in a multitude of applications ranging from office equipment to satellites.

| Contents | Page |
|---|------|
| General Application D Subminiature Connectors | |
| ● Straight PCB Selection Guide | 2 |
| D*NG Pressfit Termination | 4 |
| D*M Solder Termination (Machined) — Standard PC Tails | 6 |
| ZD* Solder Termination (Stamped) | 8 |
| D* Solder Termination (Machined) — European PC Tails | 10 |
| D* Wrap Post Termination | 12 |
| ● 90° PCB Selection Guide | 14 |
| D*M Solder Termination (Machined) — Standard Footprint .318◆ or .283◆◆ inch | 16 |
| ZED* Solder Termination (Stamped) — Standard Footprint .318 inch | 18 |
| D* Solder Termination (Machined) — European Footprint 10,2◆ or 9,4◆◆ mm | 20 |
| ZD* Solder Termination (Stamped) — European Footprint 10,2 mm | 28 |
| ● Cable Selection Guide | 30 |
| D Solder Cup Solder Termination (Machined) with Tin Shells | 32 |
| ZD* Solder Cup Solder Termination (Stamped) with Tin Shells | 34 |
| D*A Crimp Connectors without Contacts | 36 |
| D*W Discrete Wire IDC | 38 |
| Special Application D Subminiature Connectors | |
| ● Combo D® Selection Index | 42 |
| Combo D® PCB Connectors with 75 Ohm Coaxial Contacts (50 Ohm Option) | 44 |
| Combo D® PCB Connectors with High Power | 60 |
| Combo D® PCB Connectors with (Size 20) Signal Contacts Only | 74 |
| Combo D® Cable Solder Cup | 78 |
| Combo D® Cable Crimp Connectors and Shield Cans | 80 |
| Loose Contacts and Tooling | 83 |
| ● Commercial Micro D Selection Index | 96 |
| MDSM Connectors and Tooling | 98 |
| ● Filter D Selection Index | 104 |
| Product Performance | 106 |
| D*JK PCB Connectors | 108 |
| D*JT Solder Cup and Combo High Power Connectors | 122 |
| High Reliability D Subminiature Connectors | |
| ● Military/High Reliability Selection Index | 130 |
| PCB 90°, Straight, Wrap Post, and Cable Solder Cup | 132 |
| 24308-Style Cross References and Test Data | 142 |
| Military/High Reliability Combo D® | 146 |
| ● SNASA/GSFC & ESA-SCC Cross References | 195 |
| Accessories Selection Guide | |
| Backshells | 198 |
| Locking Hardware | 200 |
| Miscellaneous | 208 |
| Reader's Resource Selection Index | |
| Dimensional Reference Data | 219 |
| Lease Tooling | 220 |
| Glossary of Terms | 275 |
| Obsolete Products/Available Products Not Previously Listed | 276 |
| Part Number Index | 282 |
| Product Safety and Warranty | 283 |
| Product Safety and Warranty | 297 |

On the Cover ◀
 Filter D, Combo D®,
 Commercial Micro D
 (MDSM), Pressfit D,
 and Standard D

Our facility is not currently certified by the DLA and this product is not covered by the QPL/QML.

Combo D® is a registered trademark of ITT Cannon in the United States.
 ◆ Connector footprint measured from the front shell.
 ◆◆ Connector footprint measured from the rear shell.

D*NG - Straight Pressfit Termination

See pages 4-5.

The D*NG is based upon the specification CECC75-301-802. These connectors provide a low-cost alternative to traditional through hole solder contacts. Utilizing stamped "Eye of the Needle" compliant contact tails per IEC-352-5, the parts are quickly and easily mounted onto PCBs without soldering, crimping or specialized tooling. The socket contact engaging area utilizes a "spoon" shape with four points of interconnection. Hardware options provide flexibility and ensure that the final product fits the electrical requirements of any application.

Product Features

Quick and easy press-in installation without specialized tooling
 "Spoon" socket contact provides improved interface compared to "Tuning Fork"
 Closed-entry socket for secure blind mating
 Front-shell only design based on CECC 75-301-802
 "Eye of the Needle" compliant contact tails
 Press-in bolt for ground continuity
 #4-40 UNC and M3 hardware options

D*M Straight Solder Termination (Machined) — Standard PC Tails

See pages 6-7.

D*M straight PCB connectors, which are designed to be equivalent to MIL-C-24308 (except for finishes) for printed circuit boards and backplanes in demanding applications. Additional contact lengths, hardware and finish options available; consult factory for details.

Product Features

7.5 A current capacity
 Machined contacts
 2 contact finishes
 Optional vertical standoffs, screw locks, and boardlocks (4 prongs)
 UL file number E8572
 Dimensionally compatible with Combo D®

ZD* - Straight Solder Termination (Stamped)

See pages 8-9.

ZD* straight connectors are available for applications where price is the primary driver. They are available with or without boardlocks and screw locks.

Product Features

Stamped contacts with 5 A current capacity
 Economical
 Optional vertical standoffs with optional harpoon style boardlocks or screw locks

D* - Straight Solder Termination (Machined) — European PC Tails

See pages 10-11.

D* straight connectors are available for high performance uses according to DIN 41652. Available with European length OL contacts.

Select contact finish from 2 performance classes.

Product Features

High performance commercial connectors
 Two contact finish performance classes
 Optional vertical standoffs, threaded inserts and pushfits/boardlocks
 OL2 contact length, other lengths available
 Tin plated contact PC tails (pin & socket)
 Machined contacts

D* - Wrap Post Termination

See pages 12-13.

D* straight connectors are available for high performance uses according to DIN 41652. Contacts available in two popular lengths.

Product Features

High performance commercial class connectors
 Two contact lengths for 2 or 3 wraps
 Machined contacts

Specifications

| | |
|------------------------|----------------------------------|
| Current Rating | 5 A / 25°C, 3.5 A / 70°C ambient |
| Temperature Rating | -55°C to 125°C |
| Contact Resistance | 10 mΩ |
| Test Voltage | 1200 Vrms at Sea Level |
| ∅ Plated Through Hole | 1,09 - 0,94 (.043 - .037) |
| PC Tail Press-in Force | 100N/contact max. |
| PC Tail Push-out Force | 30N/contact min. |
| PC Board Thickness | 3,20 - 1,60 (.125 - .062) |

Materials and Finishes

| Description | Material | Finish |
|-------------|-------------------------|--|
| Shell | Steel | Tin |
| Insulator | Thermoplastic, UL 94V-0 | None (color: black) |
| Contact | Copper Alloy | Gold over Nickel (Standard) or Gold over PdNi (-408) |
| Hardware | Steel/Copper Alloy | Tin/Zinc |

Specifications

| | |
|---------------------------------|--|
| Temperature Rating | -55°C to 125°C |
| Current Rating | 7.5 A |
| Contact Resistance | 55 millivolt max at 7.5 A test current |
| Dielectric Withstanding Voltage | 1000 VAC at Sea Level |

Materials and Finishes

| Description | Material | Finish |
|-------------|-------------------------|---|
| Shell | Steel | Tin |
| Insulator | Thermoplastic, UL 94V-0 | None (color: dark green) |
| Contact | Copper Alloy | Gold over Nickel. Terminating end Tin (Socket only) |
| Hardware | Steel/Copper Alloy | Tin/Zinc |

Specifications

| | |
|---------------------------------|-----------------------|
| Temperature Rating | -55°C to 105°C |
| Current Rating | 5 A |
| Contact Resistance | 15 mΩ |
| Dielectric Withstanding Voltage | 1000 VAC at Sea Level |

Materials and Finishes

| Description | Material | Finish |
|-------------|------------------------|---------------------|
| Shell | Steel | Tin |
| Insulator | Thermoplastic, UL 94-0 | None (color: black) |
| Contacts | Copper Alloy | Gold over Nickel |
| Hardware | Steel/Copper Alloy | Tin/Zinc |

Specifications

| | |
|---------------------------------|-----------------------|
| Temperature Rating | -55°C to 125°C |
| Current Rating | 5 A |
| Contact Resistance | 10 mΩ |
| Dielectric Withstanding Voltage | 1250 VAC at Sea Level |

Materials and Finishes

| Description | Material | Finish |
|-------------|-------------------------|---|
| Shell | Steel | Tin |
| Insulator | Thermoplastic, UL 94V-0 | None (color: dark green) |
| Contacts | Copper Alloy | Gold over Nickel in mating area, Tin on balance |
| Hardware | Steel/Copper Alloy | Tin/Zinc |

Specifications

| | |
|---------------------------------|-----------------------|
| Temperature Rating | -55°C to 125°C |
| Current Rating | 5 A |
| Contact Resistance | 10 mΩ |
| Dielectric Withstanding Voltage | 1250 VAC at Sea Level |

Materials and Finishes

| Description | Material | Finish |
|-------------|-------------------------|--|
| Shell | Steel | Tin |
| Insulator | Thermoplastic, UL 94V-0 | None (color: dark green) |
| Contact | Socket: Copper Alloy | Gold over Nickel. Terminating end Tin (Socket) |
| Hardware | Steel/Copper Alloy | Tin/Zinc |

Straight Pressfit Termination

Plug



Selection Guide

For Product Features, Specifications, Materials and Finishes, see pages 2-3.

Reader's Resource

For contact cavity arrangements, see page 224.
 For P.C. hole patterns, see page 274.
 For panel cutouts, see page 221.

Part Numbers

| Shell Size | Layout | Through Hole | Clinch Nut # 4-40 UNC | Clinch Nut M3 | Press-In Bolt # 4-40 UNC | Press-In Bolt M3 |
|------------|--------|--------------|-----------------------|---------------|--------------------------|------------------|
| DE | 9 | DENG9P-P1 | DENGE9P-P1 | DENGX9P-P1 | DENGZ9P-P1 | DENGL9P-P1 |
| DA | 15 | DANG15P-P1 | DANGE15P-P1 | DANGX15P-P1 | DANGZ15P-P1 | DANGL15P-P1 |
| DB | 25 | DBNG25P-P1 | DBNGE25P-P1 | DBNGX25P-P1 | DBNGZ25P-P1 | DBNGL25P-P1 |
| DC | 37 | DCNG37P-P1 | DCNGE37P-P1 | DCNGX37P-P1 | DCNGZ37P-P1 | DCNGL37P-P1 |
| DD | 50 | DDNG50P-P1 | DDNGE50P-P1 | DDNGX50P-P1 | DDNGZ50P-P1 | DDNGL50P-P1 |

Note: For performance class 1 (gold over PdNi finish) add -408. Example: DENG9P-P1-408.



Dimensions

| Shell Size | A ±0,38 (.015) | B ±0,13 (.005) | C ±0,13 (.005) | D ±0,13 (.005) | E ±0,38 (.015) |
|------------|-------------------|-------------------|-------------------|-------------------|-------------------|
| DE | 30,81 (1.213) | 16,92 (.666) | 24,99 (.984) | 8,36 (.329) | 12,55 (.494) |
| DA | 39,14 (1.541) | 25,25 (.994) | 33,32 (1.312) | 8,36 (.329) | 12,55 (.494) |
| DB | 53,04 (2.088) | 38,96 (1.534) | 47,04 (1.852) | 8,36 (.329) | 12,55 (.494) |
| DC | 69,32 (2.729) | 55,42 (2.182) | 63,50 (2.500) | 8,36 (.329) | 12,55 (.494) |
| DD | 66,93 (2.635) | 52,81 (2.079) | 61,11 (2.406) | 11,07 (.436) | 15,37 (.605) |

Mounting Types



Straight Pressfit Termination

Receptacle



Selection Guide

For Product Features, Specifications, Materials and Finishes, see pages 2-3.

Part Numbers

| Shell Size | Layout | Through Hole | Clinch Nut # 4-40 UNC | Clinch Nut M3 | Press-In Bolt # 4-40 UNC | Press-In Bolt M3 |
|------------|--------|--------------|-----------------------|---------------|--------------------------|------------------|
| DE | 9 | DENG9S-P1 | DENGE9S-P1 | DENGX9S-P1 | DENGZ9S-P1 | DENGL9S-P1 |
| DA | 15 | DANG15S-P1 | DANGE15S-P1 | DANGX15S-P1 | DANGZ15S-P1 | DANGL15S-P1 |
| DB | 25 | DBNG25S-P1 | DBNGE25S-P1 | DBNGX25S-P1 | DBNGZ25S-P1 | DBNGL25S-P1 |
| DC | 37 | DCNG37S-P1 | DCNGE37S-P1 | DCNGX37S-P1 | DCNGZ37S-P1 | DCNGL37S-P1 |
| DD | 50 | DDNG50S-P1 | DDNGE50S-P1 | DDNGX50S-P1 | DDNGZ50S-P1 | DDNGL50S-P1 |

Note: For performance class 1 (gold over PdNi finish) add -408. Example: DENG9S-P1-408.

Reader's Resource

For contact cavity arrangements, see page 224.

For P.C. hole patterns, see page 274.

For panel cutouts, see page 221.



Dimensions

| Shell Size | A | B | C | D | E |
|------------|---------------|---------------|---------------|--------------|--------------|
| | ±0,38 (.015) | ±0,13 (.005) | ±0,13 (.005) | ±0,13 (.005) | ±0,38 (.015) |
| DE | 30,81 (1.213) | 16,33 (.643) | 24,99 (.984) | 7,90 (.311) | 12,55 (.494) |
| DA | 39,14 (1.541) | 24,66 (.971) | 33,32 (1.312) | 7,90 (.311) | 12,55 (.494) |
| DB | 53,04 (2.088) | 38,38 (1.511) | 47,04 (1.852) | 7,90 (.311) | 12,55 (.494) |
| DC | 69,32 (2.729) | 54,84 (2.159) | 63,50 (2.500) | 7,90 (.311) | 12,55 (.494) |
| DD | 66,93 (2.635) | 52,42 (2.064) | 61,11 (2.406) | 10,74 (.423) | 15,37 (.605) |

Mounting Types



Through Hole



Clinch Nut



Press-In Bolt

Straight Solder Termination (Machined) — Standard PC Tails

Plug



Part Numbers

| Shell Size | Layout | Standoff | Standoff & Boardlock | Standoff, Boardlock & Screw Lock |
|------------|--------|------------|----------------------|----------------------------------|
| DE | 9 | DEM9PNK87 | DEM9PNK87 | DEM9PNK87 |
| DA | 15 | DAM15PNK87 | DAM15PNK87 | DAM15PNK87 |
| DB | 25 | DBM25PNK87 | DBM25PNK87 | DBM25PNK87 |
| DC | 37 | DCM37PNK87 | DCM37PNK87 | DCM37PNK87 |
| DD | 50 | DDM50PNK87 | DDM50PNK87 | DDM50PNK87 |

Selection Guide

For Product Features, Specifications, Materials and Finishes, see pages 2-3.

Note: For contacts with 30 microinches gold substitute K127 for K87. Example: DEMN9PNK127

Reader's Resource

- For contact cavity arrangements, see page 224.
- For P.C. hole patterns, see page 274.
- For panel cutouts, see page 221.
- For hardware views (Standard), see page 226.



Hardware removed for clarity

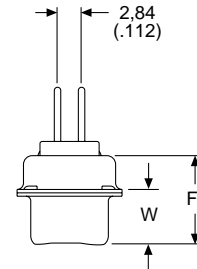

Hardware removed for clarity

Dimensions

| Shell Size | A | B | C | D | E | F | W | W | L |
|------------|---------------|---------------|---------------|--------------|--------------|--------------|----------------|--------------|--------------|
| | ±0,38 (.015) | ±0,13 (.005) | ±0,13 (.005) | ±0,13 (.005) | ±0,38 (.015) | ±0,25 (.010) | ±0,368 (.0145) | ±0,41 (.016) | ±0,25 (.010) |
| DE | 30,81 (1.213) | 16,92 (.666) | 24,99 (.984) | 8,36 (.329) | 12,55 (.494) | 10,72 (.422) | 6,693 (.2635) | — | 0,76 (.030) |
| DA | 39,14 (1.541) | 25,25 (.994) | 33,32 (1.312) | 8,36 (.329) | 12,55 (.494) | 10,72 (.422) | 6,693 (.2635) | — | 0,76 (.030) |
| DB | 53,04 (2.088) | 38,96 (1.534) | 47,04 (1.852) | 8,36 (.329) | 12,55 (.494) | 10,82 (.426) | — | 6,84 (.269) | 0,99 (.039) |
| DC | 69,32 (2.729) | 55,42 (2.182) | 63,50 (2.500) | 8,36 (.329) | 12,55 (.494) | 10,82 (.426) | — | 6,84 (.269) | 0,99 (.039) |
| DD | 66,93 (2.635) | 52,81 (2.079) | 61,11 (2.406) | 11,07 (.436) | 15,37 (.605) | 10,82 (.426) | — | 6,84 (.269) | 0,99 (.039) |

Straight Solder Termination (Machined) — Standard PC Tails

Receptacle



Part Numbers

| Shell Size | Layout | Standoff | Standoff & Boardlock | Standoff, Boardlock & Screw Lock |
|------------|--------|--------------|----------------------|----------------------------------|
| DE | 9 | DEM9SNA197 | DEMZ9SNA197 | DEMN9SNA197 |
| DA | 15 | DAMV15SNA197 | DAMZ15SNA197 | DAMN15SNA197 |
| DB | 25 | DBMV25SNA197 | DBMZ25SNA197 | DBMN25SNA197 |
| DC | 37 | DCMV37SNA197 | DCMZ37SNA197 | DCMN37SNA197 |
| DD | 50 | DDMV50SNA197 | DDMZ50SNA197 | DDMN50SNA197 |

Selection Guide

For Product Features, Specifications, Materials and Finishes, see pages 2-3.

Note: For contacts with 30 microinches gold substitute K126 for A197. Example: DEMN9SNK126

Reader's Resource

For contact cavity arrangements, see page 224.
 For P.C. hole patterns, see page 274.
 For panel cutouts, see page 221.
 For hardware views (Standard), see page 226.

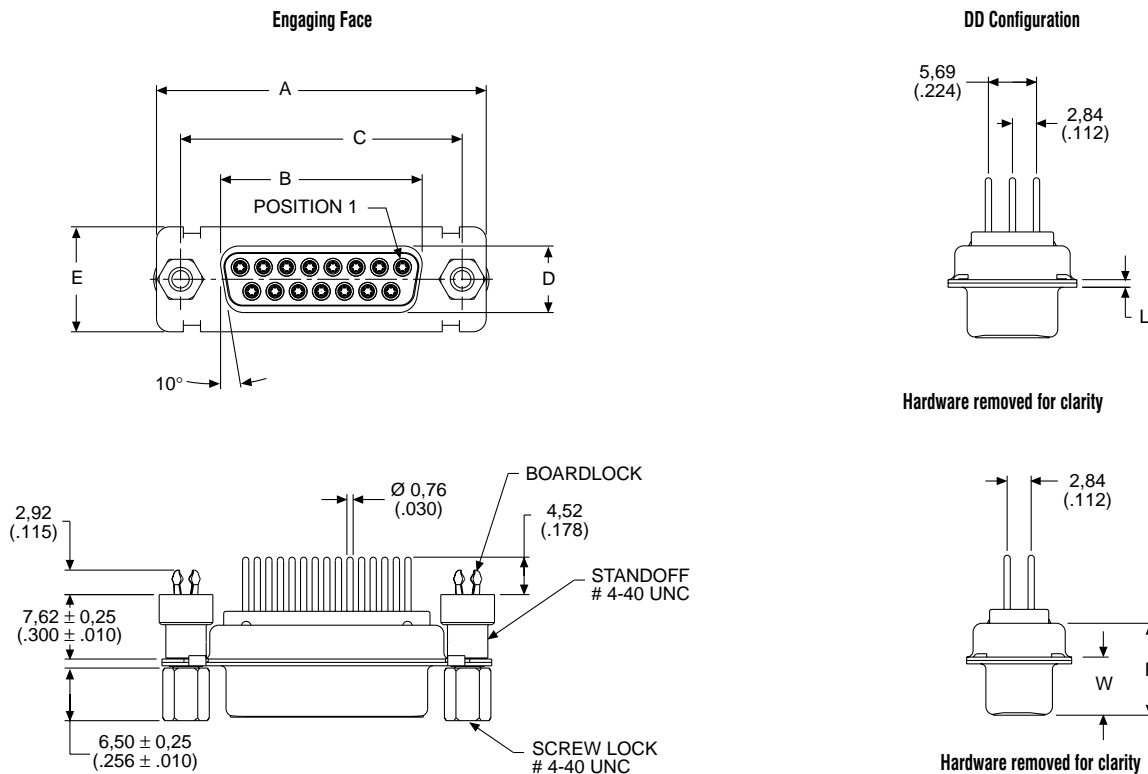

Dimensions

| Shell Size | A ±0,38 (.015) | B ±0,13 (.005) | C ±0,13 (.005) | D ±0,13 (.005) | E ±0,38 (.015) | F ±0,25 (.010) | W ±0,38 (.015) | L ±0,25 (.010) |
|------------|-------------------|-------------------|-------------------|-------------------|-------------------|-------------------|-------------------|-------------------|
| DE | 30,81 (1.213) | 16,33 (.643) | 24,99 (.984) | 7,90 (.311) | 12,55 (.494) | 10,90 (.429) | 6,94 (.273) | 0,76 (.030) |
| DA | 39,14 (1.541) | 24,66 (.971) | 33,32 (1.312) | 7,90 (.311) | 12,55 (.494) | 10,90 (.429) | 6,94 (.273) | 0,76 (.030) |
| DB | 53,04 (2.088) | 38,38 (1.511) | 47,04 (1.852) | 7,90 (.311) | 12,55 (.494) | 10,90 (.429) | 6,94 (.273) | 0,76 (.030) |
| DC | 69,32 (2.729) | 54,84 (2.159) | 63,50 (2.500) | 7,90 (.311) | 12,55 (.494) | 10,90 (.429) | 6,94 (.273) | 0,76 (.030) |
| DD | 66,93 (2.635) | 52,42 (2.064) | 61,11 (2.406) | 10,74 (.423) | 15,37 (.605) | 10,90 (.429) | 6,94 (.273) | 0,76 (.030) |

Straight Solder Termination (Stamped)

Plug



Part Numbers

| Shell Size | Layout | Through Hole | Standoff With Boardlock |
|------------|--------|--------------|-------------------------|
| DE | 9 | ZDE9P-OL2 | ZDEE9P-OL2-146 |
| DA | 15 | ZDA15P-OL2 | ZDAE15P-OL2-146 |
| DB | 25 | ZDB25P-OL2 | ZDBE25P-OL2-146 |
| DC | 37 | ZDC37P-OL2 | ZDCE37P-OL2-146 |
| DD | 50 | ZDD50P-OL2 | ZDDE50P-OL2-146 |

Selection Guide

For Product Features, Specifications, Materials and Finishes, see pages 2-3.

Reader's Resource

For contact cavity arrangements, see page 224.
 For P.C. hole patterns, see page 274.
 For panel cutouts, see page 221.
 For hardware views (Standard), see page 226.



Dimensions

| Shell Size | A ±0,38 (.015) | B ±0,13 (.005) | C ±0,13 (.005) | D ±0,13 (.005) | E ±0,38 (.015) | F ±0,25 (.010) | W ±0,368 (.0145) | W ±0,41 (.016) |
|------------|-------------------|-------------------|-------------------|-------------------|-------------------|-------------------|---------------------|-------------------|
| DE | 30,81 (1.213) | 16,92 (.666) | 24,99 (.984) | 8,36 (.329) | 12,55 (.494) | 10,72 (.422) | 6,693 (.2635) | — |
| DA | 39,14 (1.541) | 25,25 (.994) | 33,32 (1.312) | 8,36 (.329) | 12,55 (.494) | 10,72 (.422) | 6,693 (.2635) | — |
| DB | 53,04 (2.088) | 38,96 (1.534) | 47,04 (1.852) | 8,36 (.329) | 12,55 (.494) | 10,82 (.426) | — | 6,84 (.269) |
| DC | 69,32 (2.729) | 55,42 (2.182) | 63,50 (2.500) | 8,36 (.329) | 12,55 (.494) | 10,82 (.426) | — | 6,84 (.269) |
| DD | 66,93 (2.635) | 52,81 (2.079) | 61,11 (2.406) | 11,07 (.436) | 15,37 (.605) | 10,82 (.426) | — | 6,84 (.269) |

Straight Solder Termination (Stamped)

Receptacle



Part Numbers

| Shell Size | Layout | Through Hole | Standoff With Boardlock |
|------------|--------|--------------|-------------------------|
| DE | 9 | ZDE9S-OL2 | ZDEE9S-OL2-146 |
| DA | 15 | ZDA15S-OL2 | ZDAE15S-OL2-146 |
| DB | 25 | ZDB25S-OL2 | ZDBE25S-OL2-146 |
| DC | 37 | ZDC37S-OL2 | ZDCE37S-OL2-146 |
| DD | 50 | ZDD50S-OL2 | ZDEE50S-OL2-146 |

Selection Guide

For Product Features, Specifications, Materials and Finishes, see pages 2-3.

Reader's Resource

For contact cavity arrangements, see page 224.
 For P.C. hole patterns, see page 274.
 For panel cutouts, see page 221.
 For hardware views (Standard), see page 226.



Dimensions

| Shell Size | A | B | C | D | E | F | W |
|------------|---------------|---------------|---------------|--------------|--------------|--------------|--------------|
| | ±0,38 (.015) | ±0,13 (.005) | ±0,13 (.005) | ±0,13 (.005) | ±0,38 (.015) | ±0,25 (.010) | ±0,38 (.015) |
| DE | 30,81 (1.213) | 16,33 (.643) | 24,99 (.984) | 7,90 (.311) | 12,55 (.494) | 10,90 (.429) | 6,94 (.273) |
| DA | 39,14 (1.541) | 24,66 (.971) | 33,32 (1.312) | 7,90 (.311) | 12,55 (.494) | 10,90 (.429) | 6,94 (.273) |
| DB | 53,04 (2.088) | 38,38 (1.511) | 47,04 (1.852) | 7,90 (.311) | 12,55 (.494) | 10,90 (.429) | 6,94 (.273) |
| DC | 69,32 (2.729) | 54,84 (2.159) | 63,50 (2.500) | 7,90 (.311) | 12,55 (.494) | 10,90 (.429) | 6,94 (.273) |
| DD | 66,93 (2.635) | 52,42 (2.064) | 61,11 (2.406) | 10,74 (.423) | 15,37 (.605) | 10,90 (.429) | 6,94 (.273) |

Straight Solder Termination (Machined) — European PC Tails

Plug



Selection Guide

For Product Features, Specifications, Materials and Finishes, see pages 2-3.

Reader's Resource

For contact cavity arrangements, see page 224.
 For P.C. hole patterns, see page 274.
 For panel cutouts, see page 221.
 For hardware views (European), see page 227.

Part Numbers

| Shell Size | Layout | Through Hole | Standoff #4-40 UNC With Pushfit/Boardlock | Standoff M3 With Pushfit/Boardlock |
|------------|--------|---------------|---|------------------------------------|
| DE | 9 | DE9P-OL2-K87 | DEE9P-OL2-K87-146 | DEX9P-OL2-K87-146 |
| DA | 15 | DA15P-OL2-K87 | DAE15P-OL2-K87-146 | DAX15P-OL2-K87-146 |
| DB | 25 | DB25P-OL2-K87 | DBE25P-OL2-K87-146 | DBX25P-OL2-K87-146 |
| DC | 37 | DC37P-OL2-K87 | DCE37P-OL2-K87-146 | DCX37P-OL2-K87-146 |
| DD | 50 | DD50P-OL2-K87 | DDE50P-OL2-K87-146 | DDX50P-OL2-K87-146 |

Note: For performance class 2 add -A191. Example DA15P-OL2-A191-K87.

| PC Tail Modifier | X ±0,30 (.012) | Y ±0,30 (.012) |
|------------------|-------------------|-------------------|
| OL2 | 5,20 (.205) | 10,20 (.401) |
| OL4 | 6,75 (.266) | 11,80 (.465) |



Dimensions

| Shell Size | A ±0,38 (.015) | B ±0,13 (.005) | C ±0,13 (.005) | D ±0,13 (.005) | E ±0,38 (.015) | F ±0,25 (.010) | W ±0,368 (.0145) | W ±0,41 (.016) | L ±0,25 (.010) |
|------------|-------------------|-------------------|-------------------|-------------------|-------------------|-------------------|---------------------|-------------------|-------------------|
| DE | 30,81 (1.213) | 16,92 (.666) | 24,99 (.984) | 8,36 (.329) | 12,55 (.494) | 10,72 (.422) | 6,693 (.2635) | — | 0,76 (.030) |
| DA | 39,14 (1.541) | 25,25 (.994) | 33,32 (1.312) | 8,36 (.329) | 12,55 (.494) | 10,72 (.422) | 6,693 (.2635) | — | 0,76 (.030) |
| DB | 53,04 (2.088) | 38,96 (1.534) | 47,04 (1.852) | 8,36 (.329) | 12,55 (.494) | 10,82 (.426) | — | 6,84 (.269) | 0,99 (.039) |
| DC | 69,32 (2.729) | 55,42 (2.182) | 63,50 (2.500) | 8,36 (.329) | 12,55 (.494) | 10,82 (.426) | — | 6,84 (.269) | 0,99 (.039) |
| DD | 66,93 (2.635) | 52,81 (2.079) | 61,11 (2.406) | 11,07 (.436) | 15,37 (.605) | 10,82 (.426) | — | 6,84 (.269) | 0,99 (.039) |

Straight Solder Termination (Machined) — European PC Tails

Receptacle



Part Numbers

| Shell Size | Layout | Through Hole | Standoff #4-40 UNC With Pushfit/Boardlock | Standoff M3 With Pushfit/Boardlock |
|------------|--------|----------------|---|------------------------------------|
| DE | 9 | DE9S-OL2-A197 | DEE9S-OL2-A197-146 | DEX9S-OL2-A197-146 |
| DA | 15 | DA15S-OL2-A197 | DAE15S-OL2-A197-146 | DAX15S-OL2-A197-146 |
| DB | 25 | DB25S-OL2-A197 | DBE25S-OL2-A197-146 | DBX25S-OL2-A197-146 |
| DC | 37 | DC37S-OL2-A197 | DCE37S-OL2-A197-146 | DCX37S-OL2-A197-146 |
| DD | 50 | DD50S-OL2-A197 | DDE50S-OL2-A197-146 | DDX50S-OL2-A197-146 |

Selection Guide

For Product Features, Specifications, Materials and Finishes, see pages 2-3.

Note: For performance class 2 add -A191. Example DA15S-OL2-A191-A197

Reader's Resource

For contact cavity arrangements, see page 224.

For P.C. hole patterns, see page 274.

For panel cutouts, see page 221.

For hardware views (European), see page 227.

| PC Tail Modifier | X ±0,30 (.012) | Y ±0,30 (.012) |
|------------------|-------------------|-------------------|
| OL2 | 5,20 (.205) | 10,20 (.401) |
| OL4 | 6,75 (.266) | 11,80 (.465) |



Dimensions

| Shell Size | A ±0,38 (.015) | B ±0,13 (.005) | C ±0,13 (.005) | D ±0,13 (.005) | E ±0,38 (.015) | F ±0,25 (.010) | W ±0,38 (.015) | L ±0,25 (.010) |
|------------|-------------------|-------------------|-------------------|-------------------|-------------------|-------------------|-------------------|-------------------|
| DE | 30,81 (1.213) | 16,33 (.643) | 24,99 (.984) | 7,90 (.311) | 12,55 (.494) | 10,90 (.429) | 6,94 (.273) | 0,76 (.030) |
| DA | 39,14 (1.541) | 24,66 (.971) | 33,32 (1.312) | 7,90 (.311) | 12,55 (.494) | 10,90 (.429) | 6,94 (.273) | 0,76 (.030) |
| DB | 53,04 (2.088) | 38,38 (1.511) | 47,04 (1.852) | 7,90 (.311) | 12,55 (.494) | 10,90 (.429) | 6,94 (.273) | 0,76 (.030) |
| DC | 69,32 (2.729) | 54,84 (2.159) | 63,50 (2.500) | 7,90 (.311) | 12,55 (.494) | 10,90 (.429) | 6,94 (.273) | 0,76 (.030) |
| DD | 66,93 (2.635) | 52,42 (2.064) | 61,11 (2.406) | 10,74 (.423) | 15,37 (.605) | 10,90 (.429) | 6,94 (.273) | 0,76 (.030) |

Wrap Post Termination

Plug



Part Numbers

| Shell Size | Layout | Through Hole |
|------------|--------|-----------------|
| DE | 9 | DE9P-F179A-K87 |
| DA | 15 | DA15P-F179A-K87 |
| DB | 25 | DB25P-F179A-K87 |
| DC | 37 | DC37P-F179A-K87 |
| DD | 50 | DD50P-F179A-K87 |

Selection Guide

For Product Features, Specifications, Materials and Finishes, see pages 2-3.

| Modification Code | Number of Wraps | X max. | Y ±0,89 (.035) |
|-------------------|-----------------|--------------|----------------|
| F179 | 2 | 10,21 (.402) | 15,20 (.598) |
| F179A | 3 | 13,61 (.536) | 18,60 (.732) |

Reader's Resource

- For contact cavity arrangements, see page 224.
- For P.C. hole patterns, see page 274.
- For panel cutouts, see page 221.
- For hardware views (Standard), see page 226.



Dimensions

| Shell Size | A ±0,38 (.015) | B ±0,13 (.005) | C ±0,13 (.005) | D ±0,13 (.005) | E ±0,38 (.015) | F ±0,25 (.010) | W ±0,368 (.0145) | W ±0,41 (.016) | L ±0,25 (.010) |
|------------|----------------|----------------|----------------|----------------|----------------|----------------|------------------|----------------|----------------|
| DE | 30,81 (1.213) | 16,92 (.666) | 24,99 (.984) | 8,36 (.329) | 12,55 (.494) | 10,72 (.422) | 6,693 (.2635) | — | 0,76 (.030) |
| DA | 39,14 (1.541) | 25,25 (.994) | 33,32 (1.312) | 8,36 (.329) | 12,55 (.494) | 10,72 (.422) | 6,693 (.2635) | — | 0,76 (.030) |
| DB | 53,04 (2.088) | 38,96 (1.534) | 47,04 (1.852) | 8,36 (.329) | 12,55 (.494) | 10,82 (.426) | — | 6,64 (.269) | 0,99 (.039) |
| DC | 69,32 (2.729) | 55,42 (2.182) | 63,50 (2.500) | 8,36 (.329) | 12,55 (.494) | 10,82 (.426) | — | 6,64 (.269) | 0,99 (.039) |
| DD | 66,93 (2.635) | 52,81 (2.079) | 61,11 (2.406) | 11,07 (.436) | 15,37 (.605) | 10,82 (.426) | — | 6,64 (.269) | 0,99 (.039) |

Wrap Post Termination

Receptacle



Part Numbers

| Shell Size | Layout | Through Hole |
|------------|--------|------------------|
| DE | 9 | DE9S-F179A-A197 |
| DA | 15 | DA15S-F179A-A197 |
| DB | 25 | DB25S-F179A-A197 |
| DC | 37 | DC37S-F179A-A197 |
| DD | 50 | DD50S-F179A-A197 |

Selection Guide

For Product Features, Specifications, Materials and Finishes, see pages 2-3.

Reader's Resource

For contact cavity arrangements, see page 224.
 For P.C. hole patterns, see page 274.
 For panel cutouts, see page 221.
 For hardware views (Standard), see page 226.

| Modification Code | Number of Wraps | X max. | Y ±0,89 (.035) |
|-------------------|-----------------|--------------|----------------|
| F179 | 2 | 10,21 (.402) | 15,20 (.598) |
| F179A | 3 | 13,61 (.536) | 18,60 (.732) |



DD Configuration



Dimensions

| Shell Size | A ±0,13 (.005) | B ±0,13 (.005) | C ±0,13 (.005) | D ±0,13 (.005) | E ±0,38 (.015) | F ±0,25 (.010) | W ±0,38 (.015) | L ±0,25 (.010) |
|------------|----------------|----------------|----------------|----------------|----------------|----------------|----------------|----------------|
| DE | 30,81 (1.213) | 16,33 (.643) | 24,99 (.984) | 7,90 (.311) | 12,55 (.494) | 10,90 (.429) | 6,94 (.273) | 0,76 (.030) |
| DA | 39,14 (1.541) | 24,66 (.971) | 33,32 (1.312) | 7,90 (.311) | 12,55 (.494) | 10,90 (.429) | 6,94 (.273) | 0,76 (.030) |
| DB | 53,04 (2.088) | 38,38 (1.511) | 47,04 (1.852) | 7,90 (.311) | 12,55 (.494) | 10,90 (.429) | 6,94 (.273) | 0,76 (.030) |
| DC | 69,32 (2.729) | 54,84 (2.159) | 63,50 (2.500) | 7,90 (.311) | 12,55 (.494) | 10,90 (.429) | 6,94 (.273) | 0,76 (.030) |
| DD | 66,93 (2.635) | 52,42 (2.064) | 61,11 (2.406) | 10,74 (.423) | 15,37 (.605) | 10,90 (.429) | 6,94 (.273) | 0,76 (.030) |

D*M — 90° Solder Termination (Machined) — Standard Footprint .318♦ or .283 inch♦♦



See pages 16-17.

D*M 90° PCB connectors, designed to be comparable to MIL-C-24308 (except for finishes), for use with printed circuit boards in demanding applications. Additional contact lengths, hardware and finish options available; consult factory for details.

Product Features

- 7.5 A current capacity
- Machined contacts
- Two contact finishes
- Metal bracket with threaded insert standard
- Optional screw locks and boardlocks
- UL file number E8572
- Dimensionally compatible with Combo D®

ZED* — 90° Solder Termination (Stamped) — Standard Footprint .318 inch♦



See pages 18-19.

ZED* 90° connectors are available for applications where price is the primary driver. They are available with integrated plastic brackets with Standard footprints.

Product Features

- Stamped contacts with 5 A current capacity
- Economical
- Plastic bracket with integrated boardlocks and grounding strap
- Optional screw locks

D* — 90° Solder Termination (Machined) — European Footprint 10,2♦ or 9,4 mm♦♦



See pages 20-27.

D* 90° connectors are available for high performance uses according to DIN 41652. Available with European footprint 1AON contacts, plastic and metal brackets, #4-40 or M3 threads and stamped pushfits/boardlocks. Contact finish available in 2 performance classes.

Product Features

- High performance commercial class connectors
- Two contact performance classes
- Optional metal and plastic brackets, threaded standoffs, clinch nuts, and stamped pushfits/boardlocks
- Tin plated contact PC tails (pin & socket)

ZD* — 90° Solder Termination (Stamped) — European Footprint 10,2 mm♦



See pages 28-29.

ZD* 90° connectors are available for applications where price is the primary driver. They are available with integrated plastic brackets with European footprints.

Product Features

- Stamped contacts with 5 A current capacity
- Economical
- Plastic bracket with integrated boardlocks and grounding strap
- Optional screw locks

♦ Connector footprint measured from the front shell.
 ♦♦ Connector footprint measured from the rear shell.

Specifications

| | |
|---------------------------------|---|
| Temperature Rating | –55°C to 125°C |
| Current Rating | 7.5 A |
| Contact Resistance | 55 millivolt max. at 7.5 A test current |
| Dielectric Withstanding Voltage | 1000 VAC at Sea Level |

Materials and Finishes

| Description | Material | Finish |
|------------------------------|-------------------------|---|
| Shell | Steel | Tin |
| Insulator | Thermoplastic, UL 94V-0 | None (Color: dark green) |
| Pin Contact | Copper Alloy | Gold over Nickel |
| Socket Contact | Copper Alloy | Gold over Nickel in mating area, Tin on balance |
| Hardware (except Boardlocks) | Steel | Tin |
| Boardlocks | Copper Alloy | Tin |

Specifications

| | |
|---------------------------------|-----------------------|
| Temperature Rating | –55°C to 105°C |
| Current Rating | 5 A |
| Contact Resistance | 15 mΩ |
| Dielectric Withstanding Voltage | 1000 VAC at Sea Level |

Materials and Finishes

| Description | Material | Finish |
|-------------|-------------------------|---|
| Shell | Steel | Tin |
| Insulator | Thermoplastic, UL 94V-0 | None |
| Contacts | Copper Alloy | Gold over Nickel in mating area, Tin on balance |

Specifications

| | |
|---------------------------------|-----------------------|
| Temperature Rating | –55°C to +125°C |
| Current Rating | 5 A |
| Contact Resistance | 10 mΩ |
| Dielectric Withstanding Voltage | 1250 VAC at Sea Level |

Materials and Finishes

| Description | Material | Finish |
|-------------|-------------------------|---|
| Shell | Steel | Tin |
| Insulator | Thermoplastic, UL 94V-0 | None (Color: dark green) |
| Contacts | Copper Alloy | Gold over Nickel in mating area, Tin on balance |
| Hardware | Steel or Plastic | Tin or None |
| Boardlocks | Copper Alloy | Tin |

Specifications

| | |
|---------------------------------|-----------------------|
| Temperature Rating | –55°C to 105°C |
| Current Rating | 5 A |
| Contact Resistance | 15 mΩ |
| Dielectric Withstanding Voltage | 1000 VAC at Sea Level |

Materials and Finishes

| Description | Material | Finish |
|-------------|-------------------------|---|
| Shell | Steel | Tin |
| Insulator | Thermoplastic, UL 94V-0 | None |
| Contacts | Copper Alloy | Gold over Nickel in mating area, Tin on balance |

90° Solder Termination (Machined) — Standard Footprint .318♦ or .283 inch♦♦

Plug



Part Numbers

| Shell Size | Layout | Bracket | Bracket & Boardlock | Bracket & Screw Lock #4-40 UNC | Bracket, Boardlock & Screw Lock #4-40 UNC |
|------------|--------|------------|---------------------|--------------------------------|---|
| DE | 9 | DEMP9PJ87 | DEMCP9PJ87 | DEMD9PJ87 | DEMG9PJ87 |
| DA | 15 | DAMP15PJ87 | DAMC15PJ87 | DAMD15PJ87 | DAMG15PJ87 |
| DB | 25 | DBMP25PJ87 | DBMC25PJ87 | DBMD25PJ87 | DBMG25PJ87 |
| DC | 37 | DCMP37PJ87 | DCMC37PJ87 | DCMD37PJ87 | DCMG37PJ87 |
| DD | 50 | DDMP50PJ87 | DDMC50PJ87 | DDMD50PJ87 | DDMG50PJ87 |

Note: For contacts with 30 microinches gold substitute K127 for K87. Example: DAMG15PJ87

Selection Guide

For Product Features, Specifications, Materials and Finishes, see pages 14-15.

Reader's Resource

- For contact cavity arrangements, see page 224.
- For P.C. hole patterns, see page 272.
- For panel cutouts, see page 221.
- For hardware views (Standard), see page 226.
- For alternate bracket configuration (when connectors are supplied without boardlocks), see page 226.



Note: ♥ Dimension varies with alternate bracket configuration. See Reader's Resource page 226.

Dimensions

| Shell Size | A | B | C | D | E | F | W | W | L | M | N |
|------------|---------------|---------------|---------------|--------------|--------------|--------------|----------------|--------------|--------------|--------------|--------------|
| DE | ±0,38 (.015) | ±0,13 (.005) | ±0,13 (.005) | ±0,13 (.005) | ±0,38 (.015) | ±0,25 (.010) | ±0,368 (.0145) | ±0,41 (.016) | ±0,25 (.010) | ±0,25 (.010) | ±0,25 (.010) |
| DA | 30,81 (1.213) | 16,92 (.666) | 24,99 (.984) | 8,36 (.329) | 12,55 (.494) | 10,72 (.422) | 6,693 (.2635) | — | 0,76 (.030) | 12,34 (.486) | 8,64 (.340) |
| DB | 39,14 (1.541) | 25,25 (.994) | 33,32 (1.312) | 8,36 (.329) | 12,55 (.494) | 10,72 (.422) | 6,693 (.2635) | — | 0,76 (.030) | 12,34 (.486) | 8,64 (.340) |
| DC | 53,04 (2.088) | 38,96 (1.534) | 47,04 (1.852) | 8,36 (.329) | 12,55 (.494) | 10,82 (.426) | — | 6,84 (.269) | 0,99 (.039) | 12,34 (.486) | 8,64 (.340) |
| DC | 69,32 (2.729) | 55,42 (2.182) | 63,50 (2.500) | 8,36 (.329) | 12,55 (.494) | 10,82 (.426) | — | 6,84 (.269) | 0,99 (.039) | 12,34 (.486) | 8,64 (.340) |
| DD | 66,93 (2.635) | 52,81 (2.079) | 61,11 (2.406) | 11,07 (.436) | 15,37 (.605) | 10,82 (.426) | — | 6,84 (.269) | 0,99 (.039) | 13,74 (.541) | 10,06 (.396) |

- ♥ Connector footprint measured from the front shell.
- ♦♦ Connector footprint measured from the rear shell.

90° Solder Termination (Machined) — Standard Footprint $.318\blacklozenge$ or $.283\blacklozenge$

Receptacle



Selection Guide

For Product Features, Specifications, Materials and Finishes, see pages 14-15.

Reader's Resource

For contact cavity arrangements, see page 224.
 For P.C. hole patterns, see page 272.
 For panel cutouts, see page 221.
 For hardware views (Standard), see page 226.
 For alternate bracket configuration (when connectors are supplied without boardlocks), see page 226.

Part Numbers

| Shell Size | Layout | Bracket | Bracket & Boardlock | Bracket & Screw Lock #4-40 UNC | Bracket, Boardlock & Screw Lock #4-40 UNC |
|------------|--------|--------------|---------------------|--------------------------------|---|
| DE | 9 | DEMP9SJA197 | DEMC9SJA197 | DEMD9SJA197 | DEMG9SJA197 |
| DA | 15 | DAMP15SJA197 | DAMC15SJA197 | DAMD15SJA197 | DAMG15SJA197 |
| DB | 25 | DBMP25SJA197 | DBMC25SJA197 | DBMD25SJA197 | DBMG25SJA197 |
| DC | 37 | DCMP37SJA197 | DCMC37SJA197 | DCMD37SJA197 | DCMG37SJA197 |
| DD | 50 | DDMP50SJA197 | DDMC50SJA197 | DDMD50SJA197 | DDMG50SJA197 |

Note: For contacts with 30 microinches gold substitute K126 for A197. Example: DAMG15SJ126



Note: ♥ Dimension varies with alternate bracket configuration. See Reader's Resource page 226.

Dimensions

| Shell Size | A | B | C | D | E | F | W | L | M | N |
|------------|---------------|---------------|---------------|--------------|--------------|--------------|--------------|--------------|--------------|--------------|
| | ±0,38 (.015) | ±0,13 (.005) | ±0,13 (.005) | ±0,13 (.005) | ±0,38 (.015) | ±0,25 (.010) | ±0,38 (.015) | ±0,25 (.010) | ±0,25 (.010) | ±0,25 (.010) |
| DE | 30,81 (1.213) | 16,33 (.643) | 24,99 (.984) | 7,90 (.311) | 12,55 (.494) | 10,90 (.429) | 6,94 (.273) | 0,76 (.030) | 12,34 (.486) | 8,64 (.340) |
| DA | 39,14 (1.541) | 24,66 (.971) | 33,32 (1.312) | 7,90 (.311) | 12,55 (.494) | 10,90 (.429) | 6,94 (.273) | 0,76 (.030) | 12,34 (.486) | 8,64 (.340) |
| DB | 53,04 (2.088) | 38,38 (1.511) | 47,04 (1.852) | 7,90 (.311) | 12,55 (.494) | 10,90 (.429) | 6,94 (.273) | 0,76 (.030) | 12,34 (.486) | 8,64 (.340) |
| DC | 69,32 (2.729) | 54,84 (2.159) | 63,50 (2.500) | 7,90 (.311) | 12,55 (.494) | 10,90 (.429) | 6,94 (.273) | 0,76 (.030) | 12,34 (.486) | 8,64 (.340) |
| DD | 66,93 (2.635) | 52,42 (2.064) | 61,11 (2.406) | 10,74 (.423) | 15,37 (.605) | 10,90 (.429) | 6,94 (.273) | 0,76 (.030) | 13,74 (.541) | 10,06 (.396) |

- ♥ Connector footprint measured from the front shell.
- ◆ Connector footprint measured from the rear shell.

90° Solder Termination (Stamped) — Standard Footprint .318 inch

Plug



Selection Guide

For Product Features, Specifications, Materials and Finishes, see pages 14-15.

Reader's Resource

- For contact cavity arrangements, see page 224.
- For P.C. hole patterns, see page 272.
- For panel cutouts, see page 221.
- For hardware views (Standard), see page 226.

Part Numbers

| Shell Size | Layout | Plastic Bracket, Integrated Grounding Strap, Boardlock, Threaded Insert #4-40 UNC | Plastic Bracket, Integrated Grounding Strap, Boardlock, Screw Lock #4-40 UNC |
|------------|--------|---|--|
| DE | 9 | ZEDE9PBA | ZEDE9PBA |
| DA | 15 | ZEDAL15PBA | ZEDA15PBA |
| DB | 25 | ZEDBL25PBA | ZEDB25PBA |
| DC | 37 | ZEDCL37PBA | ZEDC37PBA |

Note: For contacts with 30 microinches of gold add -30. Example: ZEDE9PBA-30



Dimensions

| Shell Size | A | B | C |
|------------|---------------|---------------|---------------|
| | ±0,38 (.015) | ±0,25 (.010) | ±0,25 (.010) |
| DE | 30,89 (1.216) | 16,92 (.666) | 24,99 (.984) |
| DA | 39,09 (1.539) | 25,25 (.994) | 33,32 (1.312) |
| DB | 53,09 (2.090) | 38,96 (1.534) | 47,04 (1.852) |
| DC | 69,40 (2.732) | 55,42 (2.182) | 63,50 (2.500) |

90° Solder Termination (Stamped) — Standard Footprint .318 inch

Receptacle



Part Numbers

| Shell Size | Layout | Plastic Bracket, Integrated Grounding Strap, Boardlock, Threaded Insert #4-40 UNC | Plastic Bracket, Integrated Grounding Strap, Boardlock, Screw Lock #4-40 UNC |
|------------|--------|---|--|
| DE | 9 | ZEDEL9SBA | ZEDE9SBA |
| DA | 15 | ZEDAL15SBA | ZEDA15SBA |
| DB | 25 | ZEDBL25SBA | ZEDB25SBA |
| DC | 37 | ZEDCL37SBA | ZEDC37SBA |

Note: For contacts with 30 microinches gold add -30. Example: ZEDEL9SBA-30

Selection Guide

For Product Features, Specifications, Materials and Finishes, see pages 14-15.

Reader's Resource

For contact cavity arrangements, see page 224.

For P.C. hole patterns, see page 272.

For panel cutouts, see page 221.

For hardware views (Standard), see page 226.



Dimensions

| Shell Size | A ±0,38 (.015) | B ±0,25 (.010) | C ±0,25 (.010) |
|------------|-------------------|-------------------|-------------------|
| DE | 30,89 (1.216) | 16,28 (.641) | 24,99 (.984) |
| DA | 39,09 (1.539) | 24,66 (.971) | 33,32 (1.312) |
| DB | 53,09 (2.090) | 38,38 (1.511) | 47,04 (1.852) |
| DC | 69,40 (2.732) | 54,84 (2.159) | 63,50 (2.500) |

90° Solder Termination (Machined) — European Footprint 10,2♦ or 9,4 mm♦♦

Plug



Part Numbers

| Shell Size | Layout | Through Hole |
|------------|--------|----------------|
| DE | 9 | DE9P-1A0N-K87 |
| DA | 15 | DA15P-1A0N-K87 |
| DB | 25 | DB25P-1A0N-K87 |
| DC | 37 | DC37P-1A0N-K87 |
| DD | 50 | DD50P-1A0N-K87 |

Note: For performance class 2 add -A191. Example: DE9P-1A0N-A191-K87

Selection Guide

For Product Features, Specifications, Materials and Finishes, see pages 14-15.

Reader's Resource

For contact cavity arrangements, see page 224.
 For P.C. hole patterns, see page 273.
 For panel cutouts, see page 221.
 For hardware views (European), see page 227.



Dimensions

| Shell Size | A | B | C | D | E | F | W | W | L |
|------------|-------------------|-------------------|-------------------|-------------------|-------------------|-------------------|---------------------|-------------------|-------------------|
| | $\pm 0,38 (.015)$ | $\pm 0,13 (.005)$ | $\pm 0,13 (.005)$ | $\pm 0,13 (.005)$ | $\pm 0,38 (.015)$ | $\pm 0,25 (.010)$ | $\pm 0,368 (.0145)$ | $\pm 0,41 (.016)$ | $\pm 0,25 (.010)$ |
| DE | 30,81 (1.213) | 16,92 (.666) | 24,99 (.984) | 8,36 (.329) | 12,55 (.494) | 10,72 (.422) | 6,693 (.2635) | — | 0,76 (.030) |
| DA | 39,14 (1.541) | 25,25 (.994) | 33,32 (1.312) | 8,36 (.329) | 12,55 (.494) | 10,72 (.422) | 6,693 (.2635) | — | 0,76 (.030) |
| DB | 53,04 (2.088) | 38,96 (1.534) | 47,04 (1.852) | 8,36 (.329) | 12,55 (.494) | 10,82 (.426) | — | 6,84 (.269) | 0,99 (.039) |
| DC | 69,32 (2.729) | 55,42 (2.182) | 63,50 (2.500) | 8,36 (.329) | 12,55 (.494) | 10,82 (.426) | — | 6,84 (.269) | 0,99 (.039) |
| DD | 66,93 (2.635) | 52,81 (2.079) | 61,11 (2.406) | 11,07 (.436) | 15,37 (.605) | 10,82 (.426) | — | 6,84 (.269) | 0,99 (.039) |

- ♦ Connector footprint measured from the front shell.
- ♦♦ Connector footprint measured from the rear shell.

90° Solder Termination (Machined) — European Footprint 10,2♦ or 9,4 mm♦♦

Receptacle



Part Numbers

| Shell Size | Layout | Through Hole |
|------------|--------|-----------------|
| DE | 9 | DE9S-1AON-A197 |
| DA | 15 | DA15S-1AON-A197 |
| DB | 25 | DB25S-1AON-A197 |
| DC | 37 | DC37S-1AON-A197 |
| DD | 50 | DD50S-1AON-A197 |

Note: For performance class 2 add -A191. Example: DE9S-1AON-A191-A197

Selection Guide

For Product Features, Specifications, Materials and Finishes, see pages 14-15.

Reader's Resource

For contact cavity arrangements, see page 224.
 For P.C. hole patterns, see page 273.
 For panel cutouts, see page 221.
 For hardware views (European), see page 227.



Dimensions

| Shell Size | A | B | C | D | E | F | W | L |
|------------|-------------------|-------------------|-------------------|-------------------|-------------------|-------------------|-------------------|-------------------|
| | $\pm 0,38 (.015)$ | $\pm 0,13 (.005)$ | $\pm 0,13 (.005)$ | $\pm 0,13 (.005)$ | $\pm 0,38 (.015)$ | $\pm 0,25 (.010)$ | $\pm 0,38 (.015)$ | $\pm 0,25 (.010)$ |
| DE | 30,81 (1.213) | 16,33 (.643) | 24,99 (.984) | 7,90 (.311) | 12,55 (.494) | 10,90 (.429) | 6,94 (.273) | 0,76 (.030) |
| DA | 39,14 (1.541) | 24,66 (.971) | 33,32 (1.312) | 7,90 (.311) | 12,55 (.494) | 10,90 (.429) | 6,94 (.273) | 0,76 (.030) |
| DB | 53,04 (2.088) | 38,38 (1.511) | 47,04 (1.852) | 7,90 (.311) | 12,55 (.494) | 10,90 (.429) | 6,94 (.273) | 0,76 (.030) |
| DC | 69,32 (2.729) | 54,84 (2.159) | 63,50 (2.500) | 7,90 (.311) | 12,55 (.494) | 10,90 (.429) | 6,94 (.273) | 0,76 (.030) |
| DD | 66,93 (2.635) | 52,42 (2.064) | 61,11 (2.406) | 10,74 (.423) | 15,37 (.605) | 10,90 (.429) | 6,94 (.273) | 0,76 (.030) |

- ♦ Connector footprint measured from the front shell.
- ♦♦ Connector footprint measured from the rear shell.

90° Solder Termination (Machined) with Metal Bracket — European Footprint 10,2♦ or 9,4♦♦ mm

Plug



Part Numbers

| Shell Size | Layout | Bushing with Through Hole | Captive Nut #4-40 UNC | Captive Nut M3 | Post #4-40 UNC |
|------------|--------|---------------------------|-----------------------|----------------|----------------|
| DE | 9 | DE9P-1AFN-K87 | DE9P-1A7N-K87 | DE9P-1A9N-K87 | DE9P-1A8N-K87 |
| DA | 15 | DA15P-1AFN-K87 | DA15P-1A7N-K87 | DA15P-1A9N-K87 | DA15P-1A8N-K87 |
| DB | 25 | DB25P-1AFN-K87 | DB25P-1A7N-K87 | DB25P-1A9N-K87 | DB25P-1A8N-K87 |
| DC | 37 | DC37P-1AFN-K87 | DC37P-1A7N-K87 | DC37P-1A9N-K87 | DC37P-1A8N-K87 |
| DD | 50 | DD50P-1AFN-K87 | DD50P-1A7N-K87 | DD50P-1A9N-K87 | DD50P-1A8N-K87 |

Selection Guide

For Product Features, Specifications, Materials and Finishes, see pages 14-15.

Notes: For pushfit/boardlock option add -146. Example: DE9P-1AFN-K87-146
For performance class 2 add -A191. Example: DE9P-1AFN-A191-K87

Reader's Resource

For contact cavity arrangements, see page 224.
For P.C. hole patterns, see page 273.
For panel cutouts, see page 221.
For hardware views (European), see page 227.



Dimensions

| Shell Size | A ±0,38 (.015) | B ±0,13 (.005) | C ±0,13 (.005) | D ±0,13 (.005) | E ±0,38 (.015) | F ±0,25 (.010) | W ±0,368 (.0145) | W ±0,41 (.016) | L ±0,25 (.010) |
|------------|-------------------|-------------------|-------------------|-------------------|-------------------|-------------------|---------------------|-------------------|-------------------|
| DE | 30,81 (1.213) | 16,92 (.666) | 24,99 (.984) | 8,36 (.329) | 12,55 (.494) | 10,72 (.422) | 6,693 (.2635) | — | 0,76 (.030) |
| DA | 39,14 (1.541) | 25,25 (.994) | 33,32 (1.312) | 8,36 (.329) | 12,55 (.494) | 10,72 (.422) | 6,693 (.2635) | — | 0,76 (.030) |
| DB | 53,04 (2.088) | 38,96 (1.534) | 47,04 (1.852) | 8,36 (.329) | 12,55 (.494) | 10,82 (.426) | — | 6,84 (.269) | 0,99 (.039) |
| DC | 69,32 (2.729) | 55,42 (2.182) | 63,50 (2.500) | 8,36 (.329) | 12,55 (.494) | 10,82 (.426) | — | 6,84 (.269) | 0,99 (.039) |
| DD | 66,93 (2.635) | 52,81 (2.079) | 61,11 (2.406) | 11,07 (.436) | 15,37 (.605) | 10,82 (.426) | — | 6,84 (.269) | 0,99 (.039) |

- ♦ Connector footprint measured from the front shell.
- ♦♦ Connector footprint measured from the rear shell.

90° Solder Termination (Machined) with Metal Bracket — European Footprint 10,2♦ or 9,4♦♦ mm

Receptacle



Selection Guide

For Product Features, Specifications, Materials and Finishes, see pages 14-15.

Reader's Resource

For contact cavity arrangements, see page 224.
 For P.C. hole patterns, see page 273.
 For panel cutouts, see page 221.
 For hardware views (European), see page 227.

Part Numbers

| Shell Size | Layout | Bushing with Through Hole | Captive Nut #4-40 UNC | Captive Nut M3 | Post #4-40 UNC |
|------------|--------|---------------------------|-----------------------|-----------------|-----------------|
| DE | 9 | DE9S-1AFN-A197 | DE9S-1A7N-A197 | DE9S-1A9N-A197 | DE9S-1A8N-A197 |
| DA | 15 | DA15S-1AFN-A197 | DA15S-1A7N-A197 | DA15S-1A9N-A197 | DA15S-1A8N-A197 |
| DB | 25 | DB25S-1AFN-A197 | DB25S-1A7N-A197 | DB25S-1A9N-A197 | DB25S-1A8N-A197 |
| DC | 37 | DC37S-1AFN-A197 | DC37S-1A7N-A197 | DC37S-1A9N-A197 | DC37S-1A8N-A197 |
| DD | 50 | DD50S-1AFN-A197 | DD50S-1A7N-A197 | DD50S-1A9N-A197 | DD50S-1A8N-A197 |

Notes: For pushfit/boardlock option add -146. Example: DE9S-1AFN-A197-146
 For performance class 2 add -A191. Example: DE9S-1AFN-A191-A197



Dimensions

| Shell Size | A | B | C | D | E | F | W | L |
|------------|---------------|---------------|---------------|--------------|--------------|--------------|--------------|--------------|
| | ±0,38 (.015) | ±0,13 (.005) | ±0,13 (.005) | ±0,13 (.005) | ±0,38 (.015) | ±0,25 (.010) | ±0,38 (.015) | ±0,25 (.010) |
| DE | 30,81 (1.213) | 16,33 (.643) | 24,99 (.984) | 7,90 (.311) | 12,55 (.494) | 10,90 (.429) | 6,94 (.273) | 0,76 (.030) |
| DA | 39,14 (1.541) | 24,66 (.971) | 33,32 (1.312) | 7,90 (.311) | 12,55 (.494) | 10,90 (.429) | 6,94 (.273) | 0,76 (.030) |
| DB | 53,04 (2.088) | 38,38 (1.511) | 47,04 (1.852) | 7,90 (.311) | 12,55 (.494) | 10,90 (.429) | 6,94 (.273) | 0,76 (.030) |
| DC | 69,32 (2.729) | 54,84 (2.159) | 63,50 (2.500) | 7,90 (.311) | 12,55 (.494) | 10,90 (.429) | 6,94 (.273) | 0,76 (.030) |
| DD | 66,93 (2.635) | 52,42 (2.064) | 61,11 (2.406) | 10,74 (.423) | 15,37 (.605) | 10,90 (.429) | 6,94 (.273) | 0,76 (.030) |

- ♦ Connector footprint measured from the front shell.
- ♦♦ Connector footprint measured from the rear shell.

90° Solder Termination (Machined) with Plastic Bracket and Grounding Strap — European Footprint 10,2♦ or 9,4 mm♦♦

Plug



Part Numbers

| Shell Size | Layout | Through Hole | Captive Nut #4-40 UNC | Captive Nut M3 | Post #4-40 UNC |
|------------|--------|----------------|-----------------------|----------------|----------------|
| DE | 9 | DE9P-1ADN-K87 | DE9P-1AWN-K87 | DE9P-1AVN-K87 | DE9P-1AJN-K87 |
| DA | 15 | DA15P-1ADN-K87 | DA15P-1AWN-K87 | DA15P-1AVN-K87 | DA15P-1AJN-K87 |
| DB | 25 | DB25P-1ADN-K87 | DB25P-1AWN-K87 | DB25P-1AVN-K87 | DB25P-1AJN-K87 |
| DC | 37 | DC37P-1ADN-K87 | DC37P-1AWN-K87 | DC37P-1AVN-K87 | DC37P-1AJN-K87 |
| DD | 50 | DD50P-1ADN-K87 | DD50P-1AWN-K87 | DD50P-1AVN-K87 | DD50P-1AJN-K87 |

Notes: For pushfit/boardlock option add -146. Example: DE9P-1ADN-K87-146
 For performance class 2 add -A191. Example: DE9P-1ADN-A191-K87

Selection Guide

For Product Features, Specifications, Materials and Finishes, see pages 14-15.

Reader's Resource

For contact cavity arrangements, see page 224.
 For P.C. hole patterns, see page 273.
 For panel cutouts, see page 221.
 For hardware views (European), see page 227.



Dimensions

| Shell Size | A | B | C | D | E | F | W | W | L |
|------------|---------------|---------------|---------------|--------------|--------------|--------------|----------------|--------------|--------------|
| | ±0,38 (.015) | ±0,13 (.005) | ±0,13 (.005) | ±0,13 (.005) | ±0,38 (.015) | ±0,25 (.010) | ±0,368 (.0145) | ±0,41 (.016) | ±0,25 (.010) |
| DE | 30,81 (1.213) | 16,92 (.666) | 24,99 (.984) | 8,36 (.329) | 12,55 (.494) | 10,72 (.422) | 6,693 (.2635) | — | 0,76 (.030) |
| DA | 39,14 (1.541) | 25,25 (.994) | 33,32 (1.312) | 8,36 (.329) | 12,55 (.494) | 10,72 (.422) | 6,693 (.2635) | — | 0,76 (.030) |
| DB | 53,04 (2.088) | 38,96 (1.534) | 47,04 (1.852) | 8,36 (.329) | 12,55 (.494) | 10,82 (.426) | — | 6,84 (.269) | 0,99 (.039) |
| DC | 69,32 (2.729) | 55,42 (2.182) | 63,50 (2.500) | 8,36 (.329) | 12,55 (.494) | 10,82 (.426) | — | 6,84 (.269) | 0,99 (.039) |
| DD | 66,93 (2.635) | 52,81 (2.079) | 61,11 (2.406) | 11,07 (.436) | 15,37 (.605) | 10,82 (.426) | — | 6,84 (.269) | 0,99 (.039) |

♦ Connector footprint measured from the front shell.
 ♦♦ Connector footprint measured from the rear shell.

90° Solder Termination (Machined) with Plastic Bracket and Grounding Strap — European Footprint 10,2♦ or 9,4 mm♦♦

Receptacle



Part Numbers

| Shell Size | Layout | Through Hole | Captive Nut #4-40 UNC | Captive Nut M3 | Post #4-40 UNC |
|------------|--------|-----------------|-----------------------|-----------------|-----------------|
| DE | 9 | DE9S-1ADN-A197 | DE9S-1AWN-A197 | DE9S-1AVN-A197 | DE9S-1AJN-A197 |
| DA | 15 | DA15S-1ADN-A197 | DA15S-1AWN-A197 | DA15S-1AVN-A197 | DA15S-1AJN-A197 |
| DB | 25 | DB25S-1ADN-A197 | DB25S-1AWN-A197 | DB25S-1AVN-A197 | DB25S-1AJN-A197 |
| DC | 37 | DC37S-1ADN-A197 | DC37S-1AWN-A197 | DC37S-1AVN-A197 | DC37S-1AJN-A197 |
| DD | 50 | DD50S-1ADN-A197 | DD50S-1AWN-A197 | DD50S-1AVN-A197 | DD50S-1AJN-A197 |

Notes: For pushfit/boardlock option add -146. Example: DE9S-1ADN-A197-146
For performance class 2 add -A191. Example: DE9S-1ADN-A191-A197

Selection Guide

For Product Features, Specifications, Materials and Finishes, see pages 14-15.

Reader's Resource

For contact cavity arrangements, see page 224.
For P.C. hole patterns, see page 273.
For panel cutouts, see page 221.
For hardware views (European), see page 227.



Dimensions

| Shell Size | A | B | C | D | E | F | W | L |
|------------|---------------|---------------|---------------|--------------|--------------|--------------|--------------|--------------|
| | ±0,38 (.015) | ±0,13 (.005) | ±0,13 (.005) | ±0,13 (.005) | ±0,38 (.015) | ±0,25 (.010) | ±0,38 (.015) | ±0,25 (.010) |
| DE | 30,81 (1.213) | 16,33 (.643) | 24,99 (.984) | 7,90 (.311) | 12,55 (.494) | 10,90 (.429) | 6,94 (.273) | 0,76 (.030) |
| DA | 39,14 (1.541) | 24,66 (.971) | 33,32 (1.312) | 7,90 (.311) | 12,55 (.494) | 10,90 (.429) | 6,94 (.273) | 0,76 (.030) |
| DB | 53,04 (2.088) | 38,38 (1.511) | 47,04 (1.852) | 7,90 (.311) | 12,55 (.494) | 10,90 (.429) | 6,94 (.273) | 0,76 (.030) |
| DC | 69,32 (2.729) | 54,84 (2.159) | 63,50 (2.500) | 7,90 (.311) | 12,55 (.494) | 10,90 (.429) | 6,94 (.273) | 0,76 (.030) |
| DD | 66,93 (2.635) | 52,42 (2.064) | 61,11 (2.406) | 10,74 (.423) | 15,37 (.605) | 10,90 (.429) | 6,94 (.273) | 0,76 (.030) |

- ♦ Connector footprint measured from the front shell.
- ♦♦ Connector footprint measured from the rear shell.

90° Solder Termination (Machined) with Plastic Bracket — European Footprint 10,2♦ or 9,4 mm♦♦

Plug



Part Numbers

| Shell Size | Layout | Through Hole | Captive Nut #4-40 UNC | Captive Nut M3 | Post #4-40 UNC |
|------------|--------|----------------|-----------------------|----------------|----------------|
| DE | 9 | DE9P-1A5N-K87 | DE9P-1AUN-K87 | DE9P-1ATN-K87 | DE9P-1A6N-K87 |
| DA | 15 | DA15P-1A5N-K87 | DA15P-1AUN-K87 | DA15P-1ATN-K87 | DA15P-1A6N-K87 |
| DB | 25 | DB25P-1A5N-K87 | DB25P-1AUN-K87 | DB25P-1ATN-K87 | DB25P-1A6N-K87 |
| DC | 37 | DC37P-1A5N-K87 | DC37P-1AUN-K87 | DC37P-1ATN-K87 | DC37P-1A6N-K87 |
| DD | 50 | DD50P-1A5N-K87 | DD50P-1AUN-K87 | DD50P-1ATN-K87 | DD50P-1A6N-K87 |

Notes: For pushfit/boardlock option add -146. Example: DE9P-1A5N-K87-146
For performance class 2 add -A191. Example: DE9P-1A5N-A191-K87

Selection Guide

For Product Features, Specifications, Materials and Finishes, see pages 14-15.

Reader's Resource

For contact cavity arrangements, see page 224.
For P.C. hole patterns, see page 273.
For panel cutouts, see page 221.
For hardware views (European), see page 227.



Dimensions

| Shell Size | A | B | C | D | E | F | W | W | L |
|------------|---------------|---------------|---------------|--------------|--------------|--------------|---------------|--------------|--------------|
| | ±0,38 (.015) | ±0,13 (.005) | ±0,13 (.005) | ±0,13 (.005) | ±0,38 (.015) | ±0,25 (.010) | ±0,368 (.145) | ±0,41 (.016) | ±0,25 (.010) |
| DE | 30,81 (1.213) | 16,92 (.666) | 24,99 (.984) | 8,36 (.329) | 12,55 (.494) | 10,72 (.422) | 6,693 (.2635) | — | 0,76 (.030) |
| DA | 39,14 (1.541) | 25,25 (.994) | 33,32 (1.312) | 8,36 (.329) | 12,55 (.494) | 10,72 (.422) | 6,693 (.2635) | — | 0,76 (.030) |
| DB | 53,04 (2.088) | 38,96 (1.534) | 47,04 (1.852) | 8,36 (.329) | 12,55 (.494) | 10,82 (.426) | — | 6,84 (.269) | 0,99 (.039) |
| DC | 69,32 (2.729) | 55,42 (2.182) | 63,50 (2.500) | 8,36 (.329) | 12,55 (.494) | 10,82 (.426) | — | 6,84 (.269) | 0,99 (.039) |
| DD | 66,93 (2.635) | 52,81 (2.079) | 61,11 (2.406) | 11,07 (.436) | 15,37 (.605) | 10,82 (.426) | — | 6,84 (.269) | 0,99 (.039) |

♦ Connector footprint measured from the front shell.
♦♦ Connector footprint measured from the rear shell.

90° Solder Termination (Machined) with Plastic Bracket — European Footprint 10,2♦ or 9,4 mm♦♦

Receptacle



Part Numbers

| Shell Size | Layout | Through Hole | Captive Nut #4-40 UNC | Captive Nut M3 | Post #4-40 UNC |
|------------|--------|-----------------|-----------------------|-----------------|-----------------|
| DE | 9 | DE9S-1A5N-A197 | DE9S-1AUN-A197 | DE9S-1ATN-A197 | DE9S-1A6N-A197 |
| DA | 15 | DA15S-1A5N-A197 | DA15S-1AUN-A197 | DA15S-1ATN-A197 | DA15S-1A6N-A197 |
| DB | 25 | DB25S-1A5N-A197 | DB25S-1AUN-A197 | DB25S-1ATN-A197 | DB25S-1A6N-A197 |
| DC | 37 | DC37S-1A5N-A197 | DC37S-1AUN-A197 | DC37S-1ATN-A197 | DC37S-1A6N-A197 |
| DD | 50 | DD50S-1A5N-A197 | DD50S-1AUN-A197 | DD50S-1ATN-A197 | DD50S-1A6N-A197 |

Notes: For push/boardlock option add -146. Example: DE9S-1A5N-A197-146
 For performance class 2 add -A191. Example: DE9S-1A5N-A191-A197

Selection Guide

For Product Features, Specifications, Materials and Finishes, see pages 14-15.

Reader's Resource

For contact cavity arrangements, see page 224.
 For P.C. hole patterns, see page 273.
 For panel cutouts, see page 221.
 For hardware views (European), see page 227.



Dimensions

| Shell Size | A | B | C | D | E | F | W | L |
|------------|---------------|---------------|---------------|--------------|--------------|--------------|--------------|--------------|
| | ±0,38 (.015) | ±0,13 (.005) | ±0,13 (.005) | ±0,13 (.005) | ±0,38 (.015) | ±0,25 (.010) | ±0,38 (.015) | ±0,25 (.010) |
| DE | 30,81 (1.213) | 16,33 (.643) | 24,99 (.984) | 7,90 (.311) | 12,55 (.494) | 10,90 (.429) | 6,94 (.273) | 0,76 (.030) |
| DA | 39,14 (1.541) | 24,66 (.971) | 33,32 (1.312) | 7,90 (.311) | 12,55 (.494) | 10,90 (.429) | 6,94 (.273) | 0,76 (.030) |
| DB | 53,04 (2.088) | 38,38 (1.511) | 47,04 (1.852) | 7,90 (.311) | 12,55 (.494) | 10,90 (.429) | 6,94 (.273) | 0,76 (.030) |
| DC | 69,32 (2.729) | 54,84 (2.159) | 63,50 (2.500) | 7,90 (.311) | 12,55 (.494) | 10,90 (.429) | 6,94 (.273) | 0,76 (.030) |
| DD | 66,93 (2.635) | 52,42 (2.064) | 61,11 (2.406) | 10,74 (.423) | 15,37 (.605) | 10,90 (.429) | 6,94 (.273) | 0,76 (.030) |

♦ Connector footprint measured from the front shell.
 ♦♦ Connector footprint measured from the rear shell.

90° Solder Termination (Stamped) — European Footprint 10,2 mm

Plug



Part Numbers

| Shell Size | Layout | Plastic Bracket, Integrated Grounding Strap, Boardlock, Threaded Insert #4-40 UNC | Plastic Bracket, Integrated Grounding Strap, Boardlock, Screw Lock #4-40 UNC |
|------------|--------|---|--|
| DE | 9 | ZDEL9P-1AKN-146 | ZDE9P-1AKN-146 |
| DA | 15 | ZDAL15P-1AKN-146 | ZDA15P-1AKN-146 |
| DB | 25 | ZDBL25P-1AKN-146 | ZDB25P-1AKN-146 |
| DC | 37 | ZDCL37P-1AKN-146 | ZDC37P-1AKN-146 |

Selection Guide

For Product Features, Specifications, Materials and Finishes, see pages 14-15.

Note: For contacts with 30 microinches gold add -A191. Example: ZDEL9P-1AKN-A191-146

Reader's Resource

For contact cavity arrangements, see page 224.
 For P.C. hole patterns, see page 273.
 For panel cutouts, see page 221.
 For hardware views (European), see page 227.



Dimensions

| Shell Size | A ±0,38 (.015) | B ±0,25 (.010) | C ±0,13 (.005) |
|------------|-------------------|-------------------|-------------------|
| DE | 30,89 (1.216) | 16,92 (.666) | 24,99 (.984) |
| DA | 39,09 (1.539) | 25,25 (.994) | 33,32 (1.312) |
| DB | 53,09 (2.090) | 38,96 (1.534) | 47,04 (1.852) |
| DC | 69,40 (2.732) | 55,42 (2.182) | 63,50 (2.500) |

90° Solder Termination (Stamped) — European Footprint 10,2 mm

Receptacle



Part Numbers

| Shell Size | Layout | Plastic Bracket, Integrated Grounding Strap, Boardlock, Threaded Insert #4-40 UNC | Plastic Bracket, Integrated Grounding Strap, Boardlock, Screw Lock #4-40 UNC |
|------------|--------|---|--|
| DE | 9 | ZDEL9S-1AKN-146 | ZDE9S-1AKN-146 |
| DA | 15 | ZDAL15S-1AKN-146 | ZDA15S-1AKN-146 |
| DB | 25 | ZDBL25S-1AKN-146 | ZDB25S-1AKN-146 |
| DC | 37 | ZDCL37S-1AKN-146 | ZDC37S-1AKN-146 |

Note: For contacts with -A191 microinches gold add -A191. Example: ZDEL9S-1AKN-A191-146

Selection Guide

For Product Features, Specifications, Materials and Finishes, see pages 14-15.

Reader's Resource

For contact cavity arrangements, see page 224.
 For P.C. hole patterns, see page 273.
 For panel cutouts, see page 221.
 For hardware views (European), see page 227.



Dimensions

| Shell Size | A ±0,38 (.015) | B ±0,25 (.010) | C ±0,13 (.005) |
|------------|-------------------|-------------------|-------------------|
| DE | 30,89 (1.216) | 16,33 (.643) | 24,99 (.984) |
| DA | 39,09 (1.539) | 24,66 (.971) | 33,32 (1.312) |
| DB | 53,09 (2.090) | 38,38 (1.511) | 47,04 (1.852) |
| DC | 69,40 (2.732) | 54,84 (2.159) | 63,50 (2.500) |

D* — Solder Cup Termination (Machined) with Tin Shells

See pages 32-33.

D* solder cup connectors are used for cable or panel mount wiring applications. Solder cup connectors provide maximum flexibility and performance for applications requiring discrete solder terminations and field repair without termination tooling.

Product Features

Machined solder cup termination, 5 A current capacity
 High performance commercial class connectors
 Two contact performance classes
 Optional clinch nuts with #4-40 UNC or M3 threads

ZD* — Solder Cup Termination (Stamped) with Tin Shells

See pages 34-35.

ZD* solder cup connectors are used for cable or panel mount wiring applications. Solder cup connectors provide maximum flexibility and performance for applications requiring discrete solder terminations.

Product Features

Stamped solder cup termination, 5 A current capacity
 Economical

D*A — Crimp Connectors without Contacts

See pages 36-37.

D*A crimp contact connectors are designed for reliable, fast cabling. Available in the industry standard D*A housing, the connectors provide a low-cost, quick cabling alternative compared to soldering.

Product Features

Crimp contacts available in reels of 5,000
 Application tooling:
 – Hand or automatic
 – Stripper crimper

D*W — Discrete Wire IDC

See pages 38-41.

The D*W connector provides insulation displacement connection technology for either solid or stranded wires. With D*W, speed of cabling is increased significantly over solder cup or crimp solutions. Contacts are easily removable and replaceable. Several specialized accessories (including shield cans, ferrules, and plastic boots) are available to provide a complete product solution.

Product Features

Quick harnessing capability with simple hand or semi-automatic tooling
 Accepts 30 AWG to 20 AWG wire; sizes can be mixed
 Shield cans insure reliable shielding continuity

Specifications

| | |
|---------------------------------|----------------|
| Temperature Rating | -55°C to 125°C |
| Current Rating | 5 A |
| Contact Resistance | 10 mΩ |
| Dielectric Withstanding Voltage | 1250 VAC |

Materials and Finishes

| Description | Material | Finish |
|----------------|-------------------------|------------------|
| Shell/Hardware | Steel | Tin |
| Insulator | Thermoplastic, UL 94V-0 | None |
| Contacts | Copper Alloy | Gold over Nickel |

Specifications

| | |
|---------------------------------|-----------------------|
| Temperature Rating | -55°C to 105°C |
| Current Rating | 5 A |
| Contact Resistance | 15 mΩ |
| Dielectric Withstanding Voltage | 1000 VAC at Sea Level |

Materials and Finishes

| Description | Material | Finish |
|-------------|-------------------------|------------------|
| Shell | Steel | Tin |
| Insulator | Thermoplastic, UL 94V-0 | None |
| Contacts | Copper Alloy | Gold over Nickel |

Specifications

| | |
|---------------------------------|----------------------|
| Temperature Rating | -55°C to 105°C |
| Current Rating | 5 A (20 AWG) |
| Contact Resistance | 15 mΩ |
| Dielectric Withstanding Voltage | 500 VAC at Sea Level |

Materials and Finishes

| Description | Material | Finish |
|----------------|-------------------------|------------------|
| Shell/Hardware | Steel | Tin |
| Insulator | Thermoplastic, UL 94V-0 | None |
| Contacts | Copper Alloy | Gold over Nickel |

Specifications

| | |
|---------------------------------|--|
| Temperature Rating | -55°C to 125°C |
| Current Rating | 3 A (20 AWG) 2 A (22 AWG) 1,4 A (24 AWG) 1,2 A (26 AWG) 1 A (28 AWG) 0,8 A (30 AWG) |
| Contact Resistance | 15 mΩ |
| Dielectric Withstanding Voltage | 1000 VAC at Sea Level |

Materials and Finishes

| Description | Material | Finish |
|----------------|-------------------------|--|
| Shell/Hardware | Steel | Tin |
| Insulator | Thermoplastic, UL 94V-0 | None |
| Contacts | Copper Alloy | Gold over Nickel in mating area, Tin on balance |

Solder Cup Termination (Machined) with Tin Shells

Plug



Part Numbers

| Shell Size | Layout | Through Hole | Clinch Nut #4-40 UNC | Clinch Nut M3 |
|------------|--------|--------------|----------------------|---------------|
| DE | 9 | DE9PK87 | DEE9PK87 | DEX9PK87 |
| DA | 15 | DA15PK87 | DAE15PK87 | DAX15PK87 |
| DB | 25 | DB25PK87 | DBE25PK87 | DBX25PK87 |
| DC | 37 | DC37PK87 | DCE37PK87 | DCX37PK87 |
| DD | 50 | DD50PK87 | DDE50PK87 | DDX50PK87 |

Selection Guide

For Product Features, Specifications, Materials and Finishes, see pages 30-31.

Note: For performance class 2, add A191. Example: DA15PA191K87.

Reader's Resource

For contact cavity arrangements, see page 224.

For panel cutouts, see page 221.

For hardware views (European), see page 227.



Dimensions

| Shell Size | A | B | C | D | E | F | W | W | L |
|------------|---------------|---------------|---------------|--------------|--------------|--------------|----------------|--------------|--------------|
| | ±0,38 (.015) | ±0,13 (.005) | ±0,13 (.005) | ±0,13 (.005) | ±0,38 (.015) | ±0,25 (.010) | ±0,368 (.0145) | ±0,41 (.016) | ±0,25 (.010) |
| DE | 30,81 (1.213) | 16,92 (.666) | 24,99 (.984) | 8,36 (.329) | 12,55 (.494) | 10,72 (.422) | 6,693 (.2635) | — | 0,76 (.030) |
| DA | 39,14 (1.541) | 25,25 (.994) | 33,32 (1.312) | 8,36 (.329) | 12,55 (.494) | 10,72 (.422) | 6,693 (.2635) | — | 0,76 (.030) |
| DB | 53,04 (2.088) | 38,96 (1.534) | 47,04 (1.852) | 8,36 (.329) | 12,55 (.494) | 10,82 (.426) | — | 6,84 (.269) | 0,99 (.039) |
| DC | 69,32 (2.729) | 55,42 (2.182) | 63,50 (2.500) | 8,36 (.329) | 12,55 (.494) | 10,82 (.426) | — | 6,84 (.269) | 0,99 (.039) |
| DD | 66,93 (2.635) | 52,81 (2.079) | 61,11 (2.406) | 11,07 (.436) | 15,37 (.605) | 10,82 (.426) | — | 6,84 (.269) | 0,99 (.039) |

Solder Cup Termination (Machined) with Tin Shells

Receptacle



Part Numbers

| Shell Size | Layout | Through Hole | Clinch Nut #4-40 UNC | Clinch Nut M3 |
|------------|--------|--------------|----------------------|---------------|
| DE | 9 | DE9SA197 | DEE9SA197 | DEX9SA197 |
| DA | 15 | DA15SA197 | DAE15SA197 | DAX15SA197 |
| DB | 25 | DB25SA197 | DBE25SA197 | DBX25SA197 |
| DC | 37 | DC37SA197 | DCE37SA197 | DCX37SA197 |
| DD | 50 | DD50SA197 | DDE50SA197 | DDX50SA197 |

Selection Guide

For Product Features, Specifications, Materials and Finishes, see pages 30-31.

Note: For performance class 2, add A191. Example: DA15SA191A197.

Reader's Resource

For contact cavity arrangements, see page 224.
 For panel cutouts, see page 221.
 For hardware views (European), see page 227.



Dimensions

| Shell Size | A ±0,38 (.015) | B ±0,13 (.005) | C ±0,13 (.005) | D ±0,13 (.005) | E ±0,38 (.015) | F ±0,25 (.010) | W ±0,38 (.015) | L ±0,25 (.010) |
|------------|-------------------|-------------------|-------------------|-------------------|-------------------|-------------------|-------------------|-------------------|
| DE | 30,81 (1.213) | 16,33 (.643) | 24,99 (.984) | 7,90 (.311) | 12,55 (.494) | 10,90 (.429) | 6,94 (.273) | 0,76 (.030) |
| DA | 39,14 (1.541) | 24,66 (.971) | 33,32 (1.312) | 7,90 (.311) | 12,55 (.494) | 10,90 (.429) | 6,94 (.273) | 0,76 (.030) |
| DB | 53,04 (2.088) | 38,38 (1.511) | 47,04 (1.852) | 7,90 (.311) | 12,55 (.494) | 10,90 (.429) | 6,94 (.273) | 0,76 (.030) |
| DC | 69,32 (2.729) | 54,84 (2.159) | 63,50 (2.500) | 7,90 (.311) | 12,55 (.494) | 10,90 (.429) | 6,94 (.273) | 0,76 (.030) |
| DD | 66,93 (2.635) | 52,42 (2.064) | 61,11 (2.406) | 10,74 (.423) | 15,37 (.605) | 10,90 (.429) | 6,94 (.273) | 0,76 (.030) |

Solder Cup Termination (Stamped) with Tin Shells

Plug

Selection Guide

For Product Features, Specifications, Materials and Finishes, see pages 30-31.

Reader's Resource

For contact cavity arrangements, see page 224.

For panel cutouts, see page 221.

For hardware views (Standard), see page 226.

Part Numbers

| Shell Size | Layout | Through Hole |
|------------|--------|--------------|
| DE | 9 | ZDE9P |
| DA | 15 | ZDA15P |
| DB | 25 | ZDB25P |
| DC | 37 | ZDC37P |
| DD | 50 | ZDD50P |



DD Configuration



Dimensions

| Shell Size | A | B | C | D | E | F | W | W | K | K | L |
|------------|---------------|---------------|---------------|--------------|--------------|--------------|----------------|--------------|----------------|--------------|--------------|
| | ±0,38 (.015) | ±0,13 (.005) | ±0,13 (.005) | ±0,13 (.005) | ±0,38 (.015) | ±0,25 (.010) | ±0,368 (.0145) | ±0,41 (.016) | ±0,317 (.0125) | ±0,25 (.010) | ±0,25 (.010) |
| DE | 30,81 (1.213) | 16,92 (.666) | 24,99 (.984) | 8,36 (.329) | 12,55 (.494) | 10,72 (.422) | 6,693 (.2635) | — | 1,206 (.0475) | — | 0,76 (.030) |
| DA | 39,14 (1.541) | 25,25 (.994) | 33,32 (1.312) | 8,36 (.329) | 12,55 (.494) | 10,72 (.422) | 6,693 (.2635) | — | 1,206 (.0475) | — | 0,76 (.030) |
| DB | 53,04 (2.088) | 38,96 (1.534) | 47,04 (1.852) | 8,36 (.329) | 12,55 (.494) | 10,82 (.426) | — | 6,84 (.269) | — | 1,52 (.060) | 0,99 (.039) |
| DC | 69,32 (2.729) | 55,42 (2.182) | 63,50 (2.500) | 8,36 (.329) | 12,55 (.494) | 10,82 (.426) | — | 6,84 (.269) | — | 1,52 (.060) | 0,99 (.039) |
| DD | 66,93 (2.635) | 52,81 (2.079) | 61,11 (2.406) | 11,07 (.436) | 15,37 (.605) | 10,82 (.426) | — | 6,84 (.269) | — | 1,52 (.060) | 0,99 (.039) |

Solder Cup Termination (Stamped) with Tin Shells

Receptacle



Part Numbers

| Shell Size | Layout | Through Hole |
|------------|--------|--------------|
| DE | 9 | ZDE9S |
| DA | 15 | ZDA15S |
| DB | 25 | ZDB25S |
| DC | 37 | ZDC37S |
| DD | 50 | ZDD50S |

Selection Guide

For Product Features, Specifications, Materials and Finishes, see pages 30-31.

Reader's Resource

For contact cavity arrangements, see page 224.

For panel cutouts, see page 221.

For hardware views (Standard), see page 226.



DD Configuration



Dimensions

| Shell Size | A | B | C | D | E | F | W | K | L |
|------------|---------------|---------------|---------------|--------------|--------------|--------------|--------------|----------------|--------------|
| | ±0,38 (.015) | ±0,13 (.005) | ±0,13 (.005) | ±0,13 (.005) | ±0,38 (.015) | ±0,25 (.010) | ±0,38 (.015) | ±0,318 (.0125) | ±0,25 (.010) |
| DE | 30,81 (1.213) | 16,33 (.643) | 24,99 (.984) | 7,90 (.311) | 12,55 (.494) | 10,90 (.429) | 6,94 (.273) | 1,206 (.0475) | 0,76 (.030) |
| DA | 39,14 (1.541) | 24,66 (.971) | 33,32 (1.312) | 7,90 (.311) | 12,55 (.494) | 10,90 (.429) | 6,94 (.273) | 1,206 (.0475) | 0,76 (.030) |
| DB | 53,04 (2.088) | 38,38 (1.511) | 47,04 (1.852) | 7,90 (.311) | 12,55 (.494) | 10,90 (.429) | 6,94 (.273) | 1,206 (.0475) | 0,76 (.030) |
| DC | 69,32 (2.729) | 54,84 (2.159) | 63,50 (2.500) | 7,90 (.311) | 12,55 (.494) | 10,90 (.429) | 6,94 (.273) | 1,206 (.0475) | 0,76 (.030) |
| DD | 66,93 (2.635) | 52,42 (2.064) | 61,11 (2.406) | 10,74 (.423) | 15,37 (.605) | 10,90 (.429) | 6,94 (.273) | 1,206 (.0475) | 0,76 (.030) |

Crimp Connectors without Contacts

Plug



Part Numbers

| Shell Size | Layout | Through Hole |
|------------|--------|--------------|
| DE | 9 | DEA9PK87FO |
| DA | 15 | DAA15PK87FO |
| DB | 25 | DBA25PK87FO |
| DC | 37 | DCA37PK87FO |

Note: For crimp (size 20) contacts and tooling, see pages 83 & 275.

Selection Guide

For Product Features, Specifications, Materials and Finishes, see pages 30-31.

Reader's Resource

For contact cavity arrangements, see page 224.

For panel cutouts, see page 221.

For hardware views (Standard), see page 226.



Dimensions

| Shell Size | A ±0,38 (.015) | B ±0,13 (.005) | C ±0,13 (.005) | D ±0,13 (.005) | E ±0,38 (.015) | F ±0,25 (.010) | W ±0,368 (.0145) | W ±0,41 (.016) | K ±0,317 (.0125) | K ±0,25 (.010) | L ±0,25 (.010) |
|------------|-------------------|-------------------|-------------------|-------------------|-------------------|-------------------|---------------------|-------------------|---------------------|-------------------|-------------------|
| DE | 30,81 (1.213) | 16,92 (.666) | 24,99 (.984) | 8,36 (.329) | 12,55 (.494) | 10,72 (.422) | 6,693 (.2635) | — | 1,206 (.0475) | — | 0,76 (.030) |
| DA | 39,14 (1.541) | 25,25 (.994) | 33,32 (1.312) | 8,36 (.329) | 12,55 (.494) | 10,72 (.422) | 6,693 (.2635) | — | 1,206 (.0475) | — | 0,76 (.030) |
| DB | 53,04 (2.088) | 38,96 (1.534) | 47,04 (1.852) | 8,36 (.329) | 12,55 (.494) | 10,82 (.426) | — | 6,84 (.269) | — | 1,52 (.060) | 0,99 (.039) |
| DC | 69,32 (2.729) | 55,42 (2.182) | 63,50 (2.500) | 8,36 (.329) | 12,55 (.494) | 10,82 (.426) | — | 6,84 (.269) | — | 1,52 (.060) | 0,99 (.039) |
| DD | 66,93 (2.635) | 52,81 (2.079) | 61,11 (2.406) | 11,07 (.436) | 15,37 (.605) | 10,82 (.426) | — | 6,84 (.269) | — | 1,52 (.060) | 0,99 (.039) |

Crimp Connectors without Contacts

Receptacle



Part Numbers

| Shell Size | Layout | Through Hole |
|------------|--------|--------------|
| DE | 9 | DEA9SA197FO |
| DA | 15 | DAA15SA197FO |
| DB | 25 | DBA25SA197FO |
| DC | 37 | DCA37SA197FO |

Note: For crimp (size 20) contacts and tooling, see pages 83 & 275.

Selection Guide

For Product Features, Specifications, Materials and Finishes, see pages 30-31.

Reader's Resource

For contact cavity arrangements, see page 224.
 For panel cutouts, see page 221.
 For hardware views (Standard), see page 226.



Dimensions

| Shell Size | A | B | C | D | E | F | W | K | L |
|------------|---------------|---------------|---------------|--------------|--------------|--------------|--------------|----------------|--------------|
| | ±0,38 (.015) | ±0,13 (.005) | ±0,13 (.005) | ±0,13 (.005) | ±0,38 (.015) | ±0,25 (.010) | ±0,38 (.015) | ±0,318 (.0125) | ±0,25 (.010) |
| DE | 30,81 (1.213) | 16,33 (.643) | 24,99 (.984) | 7,90 (.311) | 12,55 (.494) | 10,90 (.429) | 6,94 (.273) | 1,206 (.0475) | 0,76 (.030) |
| DA | 39,14 (1.541) | 24,66 (.971) | 33,32 (1.312) | 7,90 (.311) | 12,55 (.494) | 10,90 (.429) | 6,94 (.273) | 1,206 (.0475) | 0,76 (.030) |
| DB | 53,04 (2.088) | 38,38 (1.511) | 47,04 (1.852) | 7,90 (.311) | 12,55 (.494) | 10,90 (.429) | 6,94 (.273) | 1,206 (.0475) | 0,76 (.030) |
| DC | 69,32 (2.729) | 54,84 (2.159) | 63,50 (2.500) | 7,90 (.311) | 12,55 (.494) | 10,90 (.429) | 6,94 (.273) | 1,206 (.0475) | 0,76 (.030) |
| DD | 66,93 (2.635) | 52,42 (2.064) | 61,11 (2.406) | 10,74 (.423) | 15,37 (.605) | 10,90 (.429) | 6,94 (.273) | 1,206 (.0475) | 0,76 (.030) |

Discrete Wire IDC

Plug



Part Numbers

| Shell Size | Layout | Through Hole | Clinch Nut #4-40 UNC | Through Hole & Shield Can Kit | Clinch Nut #4-40 UNC & Shield Can Kit |
|------------|--------|--------------|----------------------|-------------------------------|---------------------------------------|
| DE | 9 | DEW9P* | DEWE9P* | DEW9P*G | DEWE9P*G |
| DA | 15 | DAW15P* | DAWE15P* | DAW15P*G | DAWE15P*G |
| DB | 25 | DBW25P* | DBWE25P* | DBW25P*G | DBWE25P*G |
| DC | 37 | DCW37P* | DCWE37P* | DCW37P*G | DCWE37P*G |

Note: *Insert contact type. Example: DEW9P1.
 For contacts with 0,76 μm gold add -A176. Example: DEW9P1-A176.
 For shield can kit, see page 40.

Selection Guide

For Product Features, Specifications, Materials and Finishes, see pages 30-31.

Reader's Resource

For contact cavity arrangements, see page 224.
 For panel cutouts, see page 221.
 For hardware views (European), see page 227.

| Contact Types* | Wire Accommodation |
|----------------|--------------------|
| 1 | 28 AWG/30 AWG |
| 2 | 22 AWG/26 AWG |
| 3 | 20 AWG/22 AWG |

For more information, see pages 40-41.



Dimensions

| Shell Size | Layout | A ±0,38 (.015) | B ±0,12 (.005) | C ±0,12 (.005) | D ±0,13 (.005) | E ±0,38 (.015) | F ±0,25 (.010) | G max. | H ±0,25 (.010) | J ±0,25 (.010) | L ±0,25 (.010) |
|------------|--------|-------------------|-------------------|-------------------|-------------------|-------------------|-------------------|-------------|-------------------|-------------------|-------------------|
| DEW | 9 | 30,81 (1.213) | 16,91 (.666) | 24,99 (.984) | 8,35 (.329) | 12,55 (.494) | 10,71 (.422) | 6,05 (.238) | 19,27 (.759) | 10,71 (.422) | 0,76 (.030) |
| DAW | 15 | 39,14 (1.541) | 25,54 (.994) | 33,32 (1.312) | 8,35 (.329) | 12,55 (.494) | 10,71 (.422) | 6,05 (.238) | 27,50 (1.083) | 10,71 (.422) | 0,76 (.030) |
| DBW | 25 | 53,03 (2.048) | 38,96 (1.534) | 47,04 (1.852) | 8,35 (.329) | 12,55 (.494) | 10,82 (.426) | 5,99 (.236) | 41,27 (1.625) | 10,71 (.422) | 0,99 (.039) |
| DCW | 37 | 69,32 (2.729) | 55,42 (2.182) | 63,50 (2.500) | 8,35 (.329) | 12,55 (.494) | 10,82 (.426) | 5,99 (.236) | 57,70 (2.272) | 10,71 (.422) | 0,99 (.039) |

Discrete Wire IDC

Receptacle



Part Numbers

| Shell Size | Layout | Through Hole | Clinch Nut #4-40 UNC | Through Hole & Shield Can Kit | Clinch Nut #4-40 UNC & Shield Can Kit |
|------------|--------|--------------|----------------------|-------------------------------|---------------------------------------|
| DE | 9 | DEW9S* | DEWE9S* | DEW9S*G | DEWE9S*G |
| DA | 15 | DAW15S* | DAWE15S* | DAW15S*G | DAWE15S*G |
| DB | 25 | DBW25S* | DBWE25S* | DBW25S*G | DBWE25S*G |
| DC | 37 | DCW37S* | DCWE37S* | DCW37S*G | DCWE37S*G |

Note: *Insert contact type. Example: DEW9S1.
 For contacts with 0,76 μm gold add -A176. Example: DEW9S1-A176.
 For shield can kit, see page 40.

Selection Guide

For Product Features, Specifications, Materials and Finishes, see pages 30-31.

Reader's Resource

For contact cavity arrangements, see page 224.
 For panel cutouts, see page 221.
 For hardware views (European), see page 227.

| Contact Types* | Wire Accommodation |
|----------------|--------------------|
| 1 | 28 AWG/30 AWG |
| 2 | 22 AWG/26 AWG |
| 3 | 20 AWG/22 AWG |

For more information, see pages 40-41.



Dimensions

| Shell Size | Layout | A ±0,38 (.015) | B ±0,12 (.005) | C ±0,12 (.005) | D ±0,13 (.005) | E ±0,38 (.015) | F ±0,25 (.010) | G max. | H ±0,25 (.010) | J ±0,25 (.010) | L ±0,25 (.010) |
|------------|--------|-------------------|-------------------|-------------------|-------------------|-------------------|-------------------|-------------|-------------------|-------------------|-------------------|
| DEW | 9 | 30,81 (1.213) | 16,33 (.643) | 24,99 (.984) | 7,90 (.311) | 12,55 (.494) | 10,89 (.429) | 6,30 (.248) | 19,27 (.759) | 10,71 (.422) | 0,76 (.030) |
| DAW | 15 | 39,14 (1.541) | 24,66 (.971) | 33,32 (1.312) | 7,90 (.311) | 12,55 (.494) | 10,89 (.429) | 6,30 (.248) | 27,50 (1.083) | 10,71 (.422) | 0,76 (.030) |
| DBW | 25 | 53,03 (2.048) | 38,38 (1.511) | 47,04 (1.852) | 7,90 (.311) | 12,55 (.494) | 10,89 (.429) | 6,30 (.248) | 41,27 (1.625) | 10,71 (.422) | 0,76 (.030) |
| DCW | 37 | 69,32 (2.729) | 55,84 (2.159) | 63,50 (2.500) | 7,90 (.311) | 12,55 (.494) | 10,89 (.429) | 6,30 (.248) | 57,70 (2.272) | 10,71 (.422) | 0,76 (.030) |

Shield Can Kit



Materials and Finishes

Shield Can and Ferrule

Material: Steel

Finish: Tin

Ferrule

| D*W | Ø Cable | Ferrule Ø A | Ferrule Part Number | Crimp Tool Part Number | Crimp Tool Position |
|----------|--------------|--------------|---------------------|------------------------|---------------------|
| DEW9G | 4,8-5,5 | 6,25 (.246) | 304-8810-000 | D115433-1 | B |
| | 5,5-6,2 | 6,25 (.246) | 304-8810-000 | D115433-1 | A |
| | 6,2-7,2 | 8,20 (.323) | 304-8811-000 | D115433-2 | B |
| | 7,2-8,2 | 8,20 (.323) | 304-8811-000 | D115433-2 | A |
| | 8,2-9,5 | 11,50 (.452) | 304-8812-000 | D115433-3 | B |
| DBW25G | 4,8-5,5 | 6,25 (.246) | 304-8810-000 | D115433-1 | B |
| | 5,5-6,2 | 6,25 (.246) | 304-8810-000 | D115433-1 | A |
| | 6,2-7,2 | 8,20 (.323) | 304-8811-000 | D115433-2 | B |
| | 7,2-8,2 | 8,20 (.323) | 304-8811-000 | D115433-2 | A |
| | 8,2-9,5 | 11,50 (.452) | 304-8812-000 | D115433-3 | B |
| 9,5-11,1 | 11,50 (.452) | 304-8813-000 | D115433-3 | A | |



Ferrule



Wire Trim Dimensions



Crimp Tool Positions



Discrete Wire IDC Contacts

Contacts

| Contact Types | 1 | | 2 | | | 3 | |
|---------------|--------------|--|--------------|--|--|--------------|--|
| Pin | 330-8753-101 | | 330-8753-102 | | | 330-8753-103 | |
| Socket | 330-8754-101 | | 330-8754-102 | | | 330-8754-103 | |

Solid Cable

| Wire Size | 28 AWG | 30 AWG | 22 AWG | 24 AWG | 26 AWG | 20 AWG | 22 AWG |
|-------------------------|--------|--------|--------|--------|--------|--------|--------|
| Section mm ² | 0.08 | 0.05 | 0.34 | 0.22 | 0.12 | 0.60 | 0.34 |
| Internal dia. mm max | 0.32 | 0.26 | 0.62 | 0.51 | 0.40 | 0.88 | 0.62 |
| External dia. mm max | 1.30 | 1.20 | 1.45 | 1.45 | 1.40 | 1.45 | 1.45 |

Stranded Cable

| Wire Size | 28 AWG | 30 AWG | 22 AWG | 24 AWG | 26 AWG | 20 AWG | 22 AWG |
|----------------------------|----------|----------|----------|----------|----------|-----------|----------|
| Section mm ² | 0.09 | 0.05 | 0.34 | 0.22 | 0.12 | 0.60 | 0.34 |
| Composition | 7 x 0.13 | 7 x 0.10 | 7 x 0.25 | 7 x 0.20 | 7 x 0.15 | 19 x 0.20 | 7 x 0.25 |
| Internal cable dia. mm max | 0.40 | 0.30 | 0.75 | 0.60 | 0.45 | 0.97 | 0.75 |
| External wire dia. mm max | 1.30 | 1.20 | 1.45 | 1.45 | 1.40 | 1.45 | 1.45 |

Insulation Displacement Connection Concept



Tooling

Extraction Tool



Part Number
DW115394

Hand Crimp Tool



Part Number
Standard Tool: DW115394-1
Automatic Tool: DW115394-2
Tool Support: DW115394-20

Row by Row Pneumatic Press



Part Number
DW115394-501

| Selection Index | Page |
|--|-----------|
| Combo D® | |
| An Introduction | 43 |
| Combo D® PCB Connectors with Coaxial 75 Ohm Contacts (50 Ohm Option) | |
| Coaxial 90° — Standard Footprint .318◆ or .283◆◆ inch (Sizes DE-DC) | 44 |
| Coaxial 90° — Standard Footprint .489◆ or .454◆◆ inch (Size DD) | 46 |
| 13C3 Special — Receptacle Only | 48 |
| 3C3 Shielded Special — Receptacle Only | 49 |
| Coaxial 90° — European Footprint 10,2◆ or 9,4◆◆ mm (Sizes DE-DC) | 50 |
| Coaxial Straight — Standard PC Tails (Sizes DE-DC) | 52 |
| Coaxial Straight — Standard PC Tails (Size DD) | 54 |
| Coaxial Straight — European PC Tails (Sizes DE-DC) | 56 |
| Coaxial Straight — European PC Tails (Size DD) | 58 |
| Combo D® PCB Connectors with High Power Contacts | |
| 40 A High Power 90° — Standard Footprint .489◆ or .454◆◆ inch (Sizes DE-DC) | 60 |
| 40 A High Power 90° — Standard Footprint .489◆ or .454◆◆ inch (Size DD) | 62 |
| 40 A High Power 90° — European Footprint 10,2◆ or 9,4◆◆ mm (Sizes DE-DC) | 64 |
| 40 A High Power Straight — Standard PC Tails (Sizes DE-DC) | 66 |
| 40 A High Power Straight — Standard PC Tails (Size DD) | 68 |
| 40 A High Power Straight — European PC Tails (Sizes DE-DC) | 70 |
| 40 A High Power Straight — European PC Tails (Size DD) | 72 |
| Combo D® PCB Connectors with (Size 20) Signal Contacts Only | |
| 90° — European Footprint 10,2◆ or 9,4◆◆ mm (Sizes DE-DD) | 74 |
| Straight PC Tails — European (Sizes DE-DD) | 76 |
| Solder Cup (Sizes DE-DD) | 78 |
| Combo D® PCB Crimp Connectors without Contacts (Sizes DA-DD) | 80 |
| Loose Contacts and Tooling | |
| Shield Cans and Crimp Tooling | 82 |
| Crimp (Size 20) Contacts and Tooling | 83 |
| Cable (Size 8) Loose Contacts | |
| Coaxial 75 Ohm and Tooling — Straight Stamped Crimp/Crimp | 84 |
| Coaxial 75 Ohm and Tooling — 90° Crimp Braid/Solder Center Contact | 85 |
| Coaxial 50 Ohm — Straight Crimp or Solder Braid | 86 |
| Coaxial 50 Ohm — 90° Crimp or Solder Braid | 87 |
| Insertion/Extraction Instructions for Coaxial, High Power and High Voltage Contacts and Tooling | 88 |
| Coaxial Assembly Instructions and Crimp Tooling | 89 |
| High Power and Tooling — Straight Solder or Crimp | 90 |
| High Voltage — Straight / 90° | 91 |
| PCB (Size 8) Loose Contacts | |
| Coaxial 75 Ohm — Straight / 90° | 92 |
| High Power — Straight / 90° | 93 |
| High Voltage — Straight | 94 |
| PCB Guide Pin and Socket | 95 |

◆ Connector footprint measured from front shell.
◆◆ Connector footprint measured from rear shell.

Combination D Subminiature connectors offer the advantages of an industry standard shield I/O interconnect, with the flexibility of a customized special, designed for any application.

This connector system is ideal for applications that require optimization of space while improving overall shielding. Combo D® accomplishes this by combining multiple interconnect types into one fully shielded product, decreasing the number I/O interfaces and reducing the possibility of EMI/RFI leakage.

By continually investing in engineering and manufacturing technology, ITT Cannon has improved the performance and features of this popular product. This catalog contains our latest efforts to meet the global requirements of the commercial electronics industry with a flexible, reliable and cost effective connector solution.



Applications

- Video Coaxial Transmission (75 Ω)
- RF and Telecom Transmission (50 Ω)
- Power Interconnects (Up to 40 A)

Product Features

- Standard and European Footprints
- Pre-Installed 75 Ω/50 Ω Coaxial or High Power contacts (One Part Number)
- Vertical Standoffs or 90° Brackets

- 90° or Straight PCB
- PC Boards up to 3,2 (.125) Thick
- PCB Variants Available with Boardlocks and/or Screw Locks (#4-40 or M3)

Specifications

| | | | |
|--|---------------------------------------|--|---|
| Temperature Rating | -55°C to 125°C | Coaxial VSWR | Less than 1.30 + .03F for F up to 500 MHz |
| Signal Contact Current Rating | 7.5 A current capacity | Coaxial Insertion Loss | .3dB loss at 500 MHz |
| Signal Contact Resistance | 55 millivolt max. at 7.5 test current | High Power Current Rating | Up to 40 A |
| Signal Contact Dielectric Withstanding Voltage | 1250 VAC at Sea Level | High Power Dielectric Withstanding Voltage | 1000 VAC at Sea Level |
| Coaxial Current Rating | 5 A | High Voltage Current Rating | 5 A |
| Coaxial Dielectric Withstanding Voltage | 1000 VAC at Sea Level | High Voltage Contact Dielectric Withstanding Voltage | 2800 V at Sea Level |
| Coaxial Impedance | 75 Ω or 50 Ω | | |

Materials and Finishes

Connector Assembly

| Description | Material | Finish/Treatment |
|----------------|---------------------------|---|
| Shell | Steel | Tin |
| Insulator | Black Polyester, UL 94V-0 | None |
| Pin Contact | Copper Alloy | Gold over Nickel |
| Socket Contact | Copper Alloy | Gold over Nickel in mating area, Tin on balance |
| Standoff | Stainless Steel | Passivated |
| Bracket | Steel | Tin |
| Rivnut | Steel | Tin |
| Boardlock | Copper Alloy | Tin |

Coaxial/High Power/High Voltage Contact Assemblies

| | | |
|-------------------------------|---------------|--|
| Contacts and outer shells | Copper Alloy | Gold over Nickel (Tin on coax ground PC tails) |
| Ring, Retaining | Copper Alloy | Nickel |
| Insulator (Coaxial only) | Teflon | None |
| Insulator (High Voltage only) | Thermoplastic | None |

U.L. File Number: E8572

Coaxial 90° — Standard Footprint .318♦ or .283 inch♦♦ (Sizes DE-DC)

Plug



Reader's Resource

For contact cavity arrangements, see page 222.
 For P.C. hole patterns, see pages 228-229.
 For panel cutouts, see page 221.
 For hardware views (Standard), see page 226.
 For alternate bracket configuration (when connectors are supplied without boardlocks), see page 226.
 For alternate 50 Ohm coaxial configuration, see page 225.

75 Ohm Part Numbers* with Metal Bracket and Rivnut #4-40 UNC

| Shell Size | Layout | Part Number Without Screw Locks Without Boardlocks | Part Number Without Screw Locks With Boardlocks | Part Number With Screw Locks Without Boardlocks | Part Number With Screw Locks With Boardlocks |
|------------|--------|--|---|---|--|
| DE | 5W1 | DEMP5C1PJK87 | DEMC5C1PJK87 | DEMDS5C1PJK87 | DEMG5C1PJK87 |
| DA | 7W2 | DAMP7C2PJK87 | DAMC7C2PJK87 | DAMD7C2PJK87 | DAMG7C2PJK87 |
| DA | 11W1 | DAMP11C1PJK87 | DAMC11C1PJK87 | DAMD11C1PJK87 | DAMG11C1PJK87 |
| DA | 3W3 | DAMP3C3PJK87 | DAMC3C3PJK87 | DAMD3C3PJK87 | DAMG3C3PJK87 |
| DA | 3WK3♣ | DAMP3CK3PJK87TM | DAMC3CK3PJK87TM | DAMD3CK3PJK87TM | DAMG3CK3PJK87TM |
| DB | 5W5 | DBMP5C5PJK87 | DBMC5C5PJK87 | DBMD5C5PJK87 | DBMG5C5PJK87 |
| DB | 9W4 | DBMP9C4PJK87 | DBMC9C4PJK87 | DBMD9C4PJK87 | DBMG9C4PJK87 |
| DB | 13W3 | DBMP13C3PJK87 | DBMC13C3PJK87 | DBMD13C3PJK87 | DBMG13C3PJK87 |
| DB | 17W2 | DBMP17C2PJK87 | DBMC17C2PJK87 | DBMD17C2PJK87 | DBMG17C2PJK87 |
| DB | 21W1 | DBMP21C1PJK87 | DBMC21C1PJK87 | DBMD21C1PJK87 | DBMG21C1PJK87 |
| DC | 8W8 | DCMP8C8PJK87 | DCMC8C8PJK87 | DCMD8C8PJK87 | DCMG8C8PJK87 |
| DC | 13W6 | DCMP13C6PJK87 | DCMC13C6PJK87 | DCMD13C6PJK87 | DCMG13C6PJK87 |
| DC | 17W5 | DCMP17C5PJK87 | DCMC17C5PJK87 | DCMD17C5PJK87 | DCMG17C5PJK87 |
| DC | 21WA4 | DCMP21CA4PJK87 | DCMC21CA4PJK87 | DCMD21CA4PJK87 | DCMG21CA4PJK87 |
| DC | 25W3 | DCMP25C3PJK87 | DCMC25C3PJK87 | DCMD25C3PJK87 | DCMG25C3PJK87 |
| DC | 27W2 | DCMP27C2PJK87 | DCMC27C2PJK87 | DCMD27C2PJK87 | DCMG27C2PJK87 |

Notes: * For 50 Ohm Coaxial substitute X for C. Example: DEMP5X1PJK87
 For contacts with 30 micromches gold substitute K127 for K87. Example: DEMP5C1PJK127
 For DD shell sizes, see page 46.
 ♣ Keyed.



Note: ♥ Dimension varies with alternate bracket configuration, see Reader's Resource page 226.

Dimensions

| Shell Size | A | B | C | D | E | F | W | W | L |
|------------|---------------|---------------|---------------|--------------|--------------|--------------|----------------|--------------|--------------|
| | ±0.38 (.015) | ±0.13 (.005) | ±0.13 (.005) | ±0.13 (.005) | ±0.38 (.015) | ±0.25 (.010) | ±0.368 (.0145) | ±0.41 (.016) | ±0.25 (.010) |
| DE | 30.81 (1.213) | 16.92 (.666) | 24.99 (.984) | 8.36 (.329) | 12.55 (.494) | 10.72 (.422) | 6.693 (.2635) | — | 0.76 (.030) |
| DA | 39.14 (1.541) | 25.25 (.994) | 33.32 (1.312) | 8.36 (.329) | 12.55 (.494) | 10.72 (.422) | 6.693 (.2635) | — | 0.76 (.030) |
| DB | 53.04 (2.088) | 38.96 (1.534) | 47.04 (1.852) | 8.36 (.329) | 12.55 (.494) | 10.82 (.426) | — | 6.84 (.269) | 0.99 (.039) |
| DC | 69.32 (2.729) | 55.42 (2.182) | 63.50 (2.500) | 8.36 (.329) | 12.55 (.494) | 10.82 (.426) | — | 6.84 (.269) | 0.99 (.039) |

♦ Connector footprint measured from the front shell.
 ♦♦ Connector footprint measured from the rear shell.

Coaxial 90° — Standard Footprint .318♦ or .283 inch♦♦ (Sizes DE-DC)

Receptacle



Reader's Resource

For contact cavity arrangements, see page 223.
 For P.C. hole patterns, see pages 231-232.
 For panel cutouts, see page 221.
 For hardware views (Standard), see page 226.
 For alternate bracket configuration (when connectors are supplied without boardlocks), see page 226.
 For alternate 50 Ohm coaxial configuration, see page 225.

75 Ohm Part Numbers* with Metal Bracket and Rivnut #4-40 UNC

| Shell Size | Layout | Part Number Without Screw Locks Without Boardlocks | Part Number Without Screw Locks With Boardlocks | Part Number With Screw Locks Without Boardlocks | Part Number With Screw Locks With Boardlocks |
|------------|--------|--|---|---|--|
| DE | 5W1 | DEMP5C1SJA197 | DEMC5C1SJA197 | DEMD5C1SJA197 | DEMG5C1SJA197 |
| DA | 7W2 | DAMP7C2SJA197 | DAMC7C2SJA197 | DAMD7C2SJA197 | DAMG7C2SJA197 |
| DA | 11W1 | DAMP11C1SJA197 | DAMC11C1SJA197 | DAMD11C1SJA197 | DAMG11C1SJA197 |
| DA | 3W3 | DAMP3C3SJA197 | DAMC3C3SJA197 | DAMD3C3SJA197 | DAMG3C3SJA197 |
| DA | 3WK3♣ | DAMP3CK3SJA197TM | DAMC3CK3SJA197TM | DAMD3CK3SJA197TM | DAMG3CK3SJA197TM |
| DB | 5W5 | DBMP5C5SJA197 | DBMC5C5SJA197 | DBMD5C5SJA197 | DBMG5C5SJA197 |
| DB | 9W4 | DBMP9C4SJA197 | DBMC9C4SJA197 | DBMD9C4SJA197 | DBMG9C4SJA197 |
| DB | 13W3 | DBMP13C3SJA197 | DBMC13C3SJA197 | DBMD13C3SJA197 | DBMG13C3SJA197 |
| DB | 17W2 | DBMP17C2SJA197 | DBMC17C2SJA197 | DBMD17C2SJA197 | DBMG17C2SJA197 |
| DB | 21W1 | DBMP21C1SJA197 | DBMC21C1SJA197 | DBMD21C1SJA197 | DBMG21C1SJA197 |
| DC | 8W8 | DCMP8C8SJA197 | DCMC8C8SJA197 | DCMD8C8SJA197 | DCMG8C8SJA197 |
| DC | 13W6 | DCMP13C6SJA197 | DCMC13C6SJA197 | DCMD13C6SJA197 | DCMG13C6SJA197 |
| DC | 17W5 | DCMP17C5SJA197 | DCMC17C5SJA197 | DCMD17C5SJA197 | DCMG17C5SJA197 |
| DC | 21WA4 | DCMP21CA4SJA197 | DCMC21CA4SJA197 | DCMD21CA4SJA197 | DCMG21CA4SJA197 |
| DC | 25W3 | DCMP25C3SJA197 | DCMC25C3SJA197 | DCMD25C3SJA197 | DCMG25C3SJA197 |
| DC | 27W2 | DCMP27C2SJA197 | DCMC27C2SJA197 | DCMD27C2SJA197 | DCMG27C2SJA197 |

Notes: * For 50 Ohm Coaxial substitute X for C. Example: DEMP5X1SJA197
 For contacts with 30 microinches gold substitute K126 for A197. Example: DEMP5C1SJK126
 For DD Shell Sizes, see page 47.
 ♣ Keyed.



Note: ♥ Dimension varies with alternate bracket configuration, See Reader's Resource page 226.

Dimensions

| Shell Size | A | B | C | D | E | F | W | L |
|------------|---------------|---------------|---------------|--------------|--------------|--------------|--------------|--------------|
| DE | ±0,38 (.015) | ±0,13 (.005) | ±0,13 (.005) | ±0,13 (.005) | ±0,38 (.015) | ±0,25 (.010) | ±0,38 (.015) | ±0,25 (.010) |
| DA | 30,81 (1.213) | 16,33 (.643) | 24,99 (.984) | 7,90 (.311) | 12,55 (.494) | 10,90 (.429) | 6,94 (.273) | 0,76 (.030) |
| DB | 39,14 (1.541) | 24,66 (.971) | 33,32 (1.312) | 7,90 (.311) | 12,55 (.494) | 10,90 (.429) | 6,94 (.273) | 0,76 (.030) |
| DB | 53,04 (2.088) | 38,38 (1.511) | 47,04 (1.852) | 7,90 (.311) | 12,55 (.494) | 10,90 (.429) | 6,94 (.273) | 0,76 (.030) |
| DC | 69,32 (2.729) | 54,84 (2.159) | 63,50 (2.500) | 7,90 (.311) | 12,55 (.494) | 10,90 (.429) | 6,94 (.273) | 0,76 (.030) |

- ♥ Connector footprint measured from the front shell.
- ♦♦ Connector footprint measured from the rear shell.

Coaxial 90° — Standard Footprint .489♦ or .454 inch♦♦ (Size DD)

Plug



75 Ohm Part Numbers* with Metal Bracket and Rivnut #4-40 UNC

| Shell Size | Layout | Part Number Without Screw Locks Without Boardlocks | Part Number Without Screw Locks With Boardlocks | Part Number With Screw Locks Without Boardlocks | Part Number With Screw Locks With Boardlocks |
|------------|--------|--|---|---|--|
| DD | 24W7 | DDMP24C7PJK87 | DDMC24C7PJK87 | DDMD24C7PJK87 | DDMG24C7PJK87 |
| DD | 36W4 | DDMP36C4PJK87 | DDMC36C4PJK87 | DDMD36C4PJK87 | DDMG36C4PJK87 |
| DD | 43W2 | DDMP43C2PJK87 | DDMC43C2PJK87 | DDMD43C2PJK87 | DDMG43C2PJK87 |
| DD | 47W1 | DDMP47C1PJK87 | DDMC47C1PJK87 | DDMD47C1PJK87 | DDMG47C1PJK87 |

Notes: * For 50 Ohm Coaxial substitute X for C. Example: DDMG36X4PJK87
 For contacts with 30 microinches gold substitute K127 for K87. Example: DDMP24C7PJK127

Reader's Resource

- For contact cavity arrangements, see page 222.
- For P.C. hole patterns, see page 230.
- For panel cutouts, see page 221.
- For hardware views (Standard), see page 226.
- For alternate bracket configuration (when connectors are supplied without boardlocks), see page 226.
- For alternate 50 Ohm coaxial configuration, see page 225.



Screw lock, boardlock, and coaxial contacts removed for clarity



Screw lock, boardlock, and signal contacts removed for clarity



Note: ♥ Dimension varies with alternate bracket configuration, See Reader's Resource page 226.

Dimensions

| Shell Size | A | B | C | D | E | F | W | L |
|------------|---------------|---------------|---------------|--------------|--------------|--------------|--------------|--------------|
| | ±0,38 (.015) | ±0,13 (.005) | ±0,13 (.005) | ±0,13 (.005) | ±0,38 (.015) | ±0,25 (.010) | ±0,41 (.016) | ±0,25 (.010) |
| DD | 66,93 (2.635) | 52,81 (2.079) | 61,11 (2.406) | 11,07 (.436) | 15,37 (.605) | 10,82 (.426) | 6,84 (.269) | 0,99 (.039) |

- ♦ Connector footprint measured from the front shell.
- ♦♦ Connector footprint measured from the rear shell.

Coaxial 90° — Standard Footprint .489♦ or .454 inch♦♦ (Size DD)

Receptacle



75 Ohm Part Numbers* with Metal Bracket and Rivnut #4-40 UNC

| Shell Size | Layout | Part Number | Part Number | Part Number | Part Number |
|------------|--------|---|--|--|-------------------------------------|
| | | Without Screw Locks Without Boardlocks | Without Screw Locks With Boardlocks | With Screw Locks Without Boardlocks | With Screw Locks With Boardlocks |
| DD | 24W7 | DDMP24C7SJA197 | DDMC24C7SJA197 | DDMD24C7SJA197 | DDMG24C7SJA197 |
| DD | 36W4 | DDMP36C4SJA197 | DDMC36C4SJA197 | DDMD36C4SJA197 | DDMG36C4SJA197 |
| DD | 43W2 | DDMP43C2SJA197 | DDMC43C2SJA197 | DDMD43C2SJA197 | DDMG43C2SJA197 |
| DD | 47W1 | DDMP47C1SJA197 | DDMC47C1SJA197 | DDMD47C1SJA197 | DDMG47C1SJA197 |

Notes: * For 50 Ohm Coaxial substitute X for C. Example: DDMG36X4SJA197
For contacts with 30 microinches gold substitute K126 for A197. Example: DDMP24C7SJK126

Reader's Resource

- For contact cavity arrangements, see page 223.
- For P.C. hole patterns, see page 233.
- For panel cutouts, see page 221.
- For hardware views (Standard), see page 226.
- For alternate bracket configuration (when connectors are supplied without boardlocks), see page 226.
- For alternate 50 Ohm coaxial configuration, see page 225.



Screw lock, boardlock, and coaxial contact removed for clarity



Screw lock, boardlock, and signal contacts removed for clarity



Note: ♥ Dimension varies with alternate bracket configuration, See Reader's Resource page 226.

Dimensions

| Shell Size | A | B | C | D | E | F | W | L |
|------------|---------------|---------------|---------------|--------------|--------------|--------------|--------------|--------------|
| DD | ±0,38 (.015) | ±0,13 (.005) | ±0,13 (.005) | ±0,13 (.005) | ±0,38 (.015) | ±0,25 (.010) | ±0,38 (.015) | ±0,25 (.010) |
| | 66,93 (2.635) | 52,42 (2.064) | 61,11 (2.406) | 10,74 (.423) | 15,37 (.605) | 10,90 (.429) | 6,94 (.273) | 0,76 (.030) |

- ♦ Connector footprint measured from the front shell.
- ♦♦ Connector footprint measured from the rear shell.

13C3 Special — Receptacle only

Receptacle



Finishes

Signal and Coaxial
Center Contact Finish: 30 μ inches Gold.

Note: For additional materials and finishes, see introduction page 43.

Part Number

DB111949-43

Reader's Resource

For contact cavity arrangements, see page 223.

For P.C. hole patterns, see page 236 (Rear shell REF. is 0,76 (.030) from front shell).

For panel cutouts, see page 221.



3C3 Shielded Special — Receptacle only

Receptacle



Materials and Finishes

| | |
|--------------------------------|------------------|
| Body Material: | Zinc |
| Body Finish: | Tin |
| Coaxial Center Contact Finish: | 30 μ inches Gold |

Part Number

DAM53512-1405

Note: For additional materials and finishes, see introduction page 43.

Reader's Resource

- For contact cavity arrangements, see page 223.
- For P.C. hole patterns, see page 231.
- For panel cutouts, see page 221.



Note: Connector supplied with boardlocks.

Dimensions

| Shell Size | A ±0,38 (.015) | B ±0,13 (.005) | C ±0,13 (.005) | D ±0,13 (.005) | E ±0,38 (.015) | F ±0,25 (.010) | W ±0,25 (.010) |
|------------|-------------------|-------------------|-------------------|-------------------|-------------------|-------------------|-------------------|
| DA | 39,14 (1.541) | 24,66 (.971) | 33,32 (1.312) | 7,90 (.311) | 12,55 (.494) | 10,90 (.429) | 6,17 (.243) |

Coaxial 90° — European Footprint 10,2♦ or 9,4 mm♦♦ (Sizes DE-DC)

Plug



Reader's Resource

For contact cavity arrangements, see page 222.
 For P.C. hole patterns, see page 234-235.
 For panel cutouts, see page 221.
 For alternate bracket configuration (when connectors are supplied without boardlocks), see page 226.
 For alternate 50 Ohm coaxial configuration, see page 225.

75 Ohm Part Numbers* with Metal Bracket and Rivnut #4-40 UNC

| Shell Size | Layout | Part Number Without Screw Locks Without Boardlocks | Part Number Without Screw Locks With Boardlocks | Part Number With Screw Locks Without Boardlocks | Part Number With Screw Locks With Boardlocks |
|------------|--------|--|---|---|--|
| DE | 5W1 | DEMP5C1PVK87 | DEMC5C1PVK87 | DEMD5C1PVK87 | DEMG5C1PVK87 |
| DA | 7W2 | DAMP7C2PVK87 | DAMC7C2PVK87 | DAMD7C2PVK87 | DAMG7C2PVK87 |
| DA | 11W1 | DAMP11C1PVK87 | DAMC11C1PVK87 | DAMD11C1PVK87 | DAMG11C1PVK87 |
| DA | 3W3 | DAMP3C3PVK87 | DAMC3C3PVK87 | DAMD3C3PVK87 | DAMG3C3PVK87 |
| DA | 3WK3♣ | DAMP3CK3PVK87TM | DAMC3CK3PVK87TM | DAMD3CK3PVK87TM | DAMG3CK3PVK87TM |
| DB | 5W5 | DBMP5C5PVK87 | DBMC5C5PVK87 | DBMD5C5PVK87 | DBMG5C5PVK87 |
| DB | 9W4 | DBMP9C4PVK87 | DBMC9C4PVK87 | DBMD9C4PVK87 | DBMG9C4PVK87 |
| DB | 13W3 | DBMP13C3PVK87 | DBMC13C3PVK87 | DBMD13C3PVK87 | DBMG13C3PVK87 |
| DB | 17W2 | DBMP17C2PVK87 | DBMC17C2PVK87 | DBMD17C2PVK87 | DBMG17C2PVK87 |
| DB | 21W1 | DBMP21C1PVK87 | DBMC21C1PVK87 | DBMD21C1PVK87 | DBMG21C1PVK87 |
| DC | 8W8 | DCMP8C8PVK87 | DCMC8C8PVK87 | DCMD8C8PVK87 | DCMG8C8PVK87 |
| DC | 13W6 | DCMP13C6PVK87 | DCMC13C6PVK87 | DCMD13C6PVK87 | DCMG13C6PVK87 |
| DC | 17W5 | DCMP17C5PVK87 | DCMC17C5PVK87 | DCMD17C5PVK87 | DCMG17C5PVK87 |
| DC | 21WA4 | DCMP21CA4PVK87 | DCMC21CA4PVK87 | DCMD21CA4PVK87 | DCMG21CA4PVK87 |
| DC | 25W3 | DCMP25C3PVK87 | DCMC25C3PVK87 | DCMD25C3PVK87 | DCMG25C3PVK87 |
| DC | 27W2 | DCMP27C2PVK87 | DCMC27C2PVK87 | DCMD27C2PVK87 | DCMG27C2PVK87 |

For M3 threads replace MP with MS, MC with ML, MD with MO, MG with MJ.
 Notes: * For 50 Ohm Coaxial substitute X for C. Example: DEMP5X1PVK87
 For tin plated PC tails add A226 (signal contacts only). Example: DEMP5C1PVK87A226
 For performance class 2 substitute K127 for K87. Example: DEMP5C1PVK127
 For DD shell sizes (Standard footprint) see page 46.
 ♣ Keyed.



Note: ♥ Dimension varies with alternate bracket configuration, see Reader's Resource page 226.

Dimensions

| Shell Size | A | B | C | D | E | F | W | W | L |
|------------|---------------|---------------|---------------|--------------|--------------|--------------|----------------|--------------|--------------|
| | ±0,38 (.015) | ±0,13 (.005) | ±0,13 (.005) | ±0,13 (.005) | ±0,38 (.015) | ±0,25 (.010) | ±0,368 (.0145) | ±0,41 (.016) | ±0,25 (.010) |
| DE | 30,81 (1.213) | 16,92 (.666) | 24,99 (.984) | 8,36 (.329) | 12,55 (.494) | 10,72 (.422) | 6,693 (.2635) | — | 0,76 (.030) |
| DA | 39,14 (1.541) | 25,25 (.994) | 33,32 (1.312) | 8,36 (.329) | 12,55 (.494) | 10,72 (.422) | 6,693 (.2635) | — | 0,76 (.030) |
| DB | 53,04 (2.088) | 38,96 (1.534) | 47,04 (1.852) | 8,36 (.329) | 12,55 (.494) | 10,82 (.426) | — | 6,84 (.269) | 0,99 (.039) |
| DC | 69,32 (2.729) | 55,42 (2.182) | 63,50 (2.500) | 8,36 (.329) | 12,55 (.494) | 10,82 (.426) | — | 6,84 (.269) | 0,99 (.039) |

- ♦ Connector footprint measured from the front shell.
- ♦♦ Connector footprint measured from the rear shell.

Coaxial 90° — European Footprint 10,2♦ or 9,4 mm♦♦ (Sizes DE-DC)

Receptacle



Reader's Resource

For contact cavity arrangements, see page 223.
 For P.C. hole patterns, see pages 236-237.
 For panel cutouts, see page 221.
 For alternate bracket configuration (when connectors are supplied without boardlocks), see page 226.
 For alternate 50 Ohm coaxial configuration, see page 225.

75 Ohm Part Numbers* with Metal Bracket and Rivnut #4-40 UNC

| Shell Size | Layout | Part Number Without Screw Locks Without Boardlocks | Part Number Without Screw Locks With Boardlocks | Part Number With Screw Locks Without Boardlocks | Part Number With Screw Locks With Boardlocks |
|------------|--------|--|---|---|--|
| DE | 5W1 | DEMP5C1SVA197 | DEMC5C1SVA197 | DEMD5C1SVA197 | DEMG5C1SVA197 |
| DA | 7W2 | DAMP7C2SVA197 | DAMC7C2SVA197 | DAMD7C2SVA197 | DAMG7C2SVA197 |
| DA | 11W1 | DAMP11C1SVA197 | DAMC11C1SVA197 | DAMD11C1SVA197 | DAMG11C1SVA197 |
| DA | 3W3 | DAMP3C3SVA197 | DAMC3C3SVA197 | DAMD3C3SVA197 | DAMG3C3SVA197 |
| DA | 3WK3♣ | DAMP3CK3SVA197TM | DAMC3CK3SVA197TM | DAMD3CK3SVA197TM | DAMG3CK3SVA197TM |
| DB | 5W5 | DBMP5C5SVA197 | DBMC5C5SVA197 | DBMD5C5SVA197 | DBMG5C5SVA197 |
| DB | 9W4 | DBMP9C4SVA197 | DBMC9C4SVA197 | DBMD9C4SVA197 | DBMG9C4SVA197 |
| DB | 13W3 | DBMP13C3SVA197 | DBMC13C3SVA197 | DBMD13C3SVA197 | DBMG13C3SVA197 |
| DB | 17W2 | DBMP17C2SVA197 | DBMC17C2SVA197 | DBMD17C2SVA197 | DBMG17C2SVA197 |
| DB | 21W1 | DBMP21C1SVA197 | DBMC21C1SVA197 | DBMD21C1SVA197 | DBMG21C1SVA197 |
| DC | 8W8 | DCMP8C8SVA197 | DCMC8C8SVA197 | DCMD8C8SVA197 | DCMG8C8SVA197 |
| DC | 13W6 | DCMP13C6SVA197 | DCMC13C6SVA197 | DCMD13C6SVA197 | DCMG13C6SVA197 |
| DC | 17W5 | DCMP17C5SVA197 | DCMC17C5SVA197 | DCMD17C5SVA197 | DCMG17C5SVA197 |
| DC | 21WA4 | DCMP21CA4SVA197 | DCMC21CA4SVA197 | DCMD21CA4SVA197 | DCMG21CA4SVA197 |
| DC | 25W3 | DCMP25C3SVA197 | DCMC25C3SVA197 | DCMD25C3SVA197 | DCMG25C3SVA197 |
| DC | 27W2 | DCMP27C2SVA197 | DCMC27C2SVA197 | DCMD27C2SVA197 | DCMG27C2SVA197 |

For M3 threads replace MP with MS, MC with ML, MD with MO, MG with MJ.
 Notes: * For 50 Ohm Coaxial substitute X for C. Example: DEMP5X1SVA197
 For performance class 2 substitute K126 for A197. Example: DEMP5C1SVK126
 For DD shell sizes (standard footprint) see page 47.
 ♣ Keyed.



Note: ♥ Dimension varies with alternate bracket configuration, see Reader's Resource page 226.

Dimensions

| Shell Size | A | B | C | D | E | F | W | L |
|------------|---------------|---------------|---------------|--------------|--------------|--------------|--------------|--------------|
| | ±0,38 (.015) | ±0,13 (.005) | ±0,13 (.005) | ±0,13 (.005) | ±0,38 (.015) | ±0,25 (.010) | ±0,38 (.015) | ±0,25 (.010) |
| DE | 30,81 (1.213) | 16,33 (.643) | 24,99 (.984) | 7,90 (.311) | 12,55 (.494) | 10,90 (.429) | 6,94 (.273) | 0,76 (.030) |
| DA | 39,14 (1.541) | 24,66 (.971) | 33,32 (1.312) | 7,90 (.311) | 12,55 (.494) | 10,90 (.429) | 6,94 (.273) | 0,76 (.030) |
| DB | 53,04 (2.088) | 38,38 (1.511) | 47,04 (1.852) | 7,90 (.311) | 12,55 (.494) | 10,90 (.429) | 6,94 (.273) | 0,76 (.030) |
| DC | 69,32 (2.729) | 54,84 (2.159) | 63,50 (2.500) | 7,90 (.311) | 12,55 (.494) | 10,90 (.429) | 6,94 (.273) | 0,76 (.030) |

♦ Connector footprint measured from the front shell.
 ♦♦ Connector footprint measured from the rear shell.

Coaxial Straight — Standard PC Tails (Sizes DE-DC)

Plug



Reader's Resource

For contact cavity arrangements, see page 222.
 For P.C. hole patterns, see pages 238-239.
 For panel cutouts, see page 221.
 For alternate 50 Ohm coaxial configuration, see page 225.

75 Ohm Part Numbers* with Standoff #4-40 UNC

| Shell Size | Layout | Part Number Without Screw Locks Without Boardlocks | Part Number Without Screw Locks With Boardlocks | Part Number With Screw Locks With Boardlocks |
|------------|--------|--|---|--|
| DE | 5W1 | DEM5C1PNK87 | DEMZ5C1PNK87 | DEMN5C1PNK87 |
| DA | 7W2 | DAMV7C2PNK87 | DAMZ7C2PNK87 | DAMN7C2PNK87 |
| DA | 11W1 | DAMV11C1PNK87 | DAMZ11C1PNK87 | DAMN11C1PNK87 |
| DA | 3W3 | DAMV3C3PNK87 | DAMZ3C3PNK87 | DAMN3C3PNK87 |
| DA | 3WK3♣ | DAMV3CK3PNK87TM | DAMZ3CK3PNK87TM | DAMN3CK3PNK87TM |
| DB | 5W5 | DBMV5C5PNK87 | DBMZ5C5PNK87 | DBMN5C5PNK87 |
| DB | 9W4 | DBMV9C4PNK87 | DBMZ9C4PNK87 | DBMN9C4PNK87 |
| DB | 13W3 | DBMV13C3PNK87 | DBMZ13C3PNK87 | DBMN13C3PNK87 |
| DB | 17W2 | DBMV17C2PNK87 | DBMZ17C2PNK87 | DBMN17C2PNK87 |
| DB | 21W1 | DBMV21C1PNK87 | DBMZ21C1PNK87 | DBMN21C1PNK87 |
| DC | 8W8 | DCMV8C8PNK87 | DCMZ8C8PNK87 | DCMN8C8PNK87 |
| DC | 13W6 | DCMV13C6PNK87 | DCMZ13C6PNK87 | DCMN13C6PNK87 |
| DC | 17W5 | DCMV17C5PNK87 | DCMZ17C5PNK87 | DCMN17C5PNK87 |
| DC | 21WA4 | DCMV21CA4PNK87 | DCMZ21CA4PNK87 | DCMN21CA4PNK87 |
| DC | 25W3 | DCMV25C3PNK87 | DCMZ25C3PNK87 | DCMN25C3PNK87 |
| DC | 27W2 | DCMV27C2PNK87 | DCMZ27C2PNK87 | DCMN27C2PNK87 |

Notes: * For 50 Ohm Coaxial substitute X for C. Example: DEMV5X1PNK87
 For contacts with 30 microinches gold substitute K127 for K87. Example: DEMN5C1PNK127
 For DD shell sizes, see page 54.
 ♣ Keyed.



Screw lock, boardlock, and signal contacts removed for clarity



Screw lock, boardlock, and coaxial contact removed for clarity

Dimensions

| Shell Size | A | B | C | D | E | F | W | W | L |
|------------|---------------|---------------|---------------|--------------|--------------|--------------|----------------|--------------|--------------|
| | ±0,38 (.015) | ±0,13 (.005) | ±0,13 (.005) | ±0,13 (.005) | ±0,38 (.015) | ±0,25 (.010) | ±0,368 (.0145) | ±0,41 (.016) | ±0,25 (.010) |
| DE | 30,81 (1.213) | 16,92 (.666) | 24,99 (.984) | 8,36 (.329) | 12,55 (.494) | 10,72 (.422) | 6,693 (.2635) | — | 0,76 (.030) |
| DA | 39,14 (1.541) | 25,25 (.994) | 33,32 (1.312) | 8,36 (.329) | 12,55 (.494) | 10,72 (.422) | 6,693 (.2635) | — | 0,76 (.030) |
| DB | 53,04 (2.088) | 38,96 (1.534) | 47,04 (1.852) | 8,36 (.329) | 12,55 (.494) | 10,82 (.426) | — | 6,84 (.269) | 0,99 (.039) |
| DC | 69,32 (2.729) | 55,42 (2.182) | 63,50 (2.500) | 8,36 (.329) | 12,55 (.494) | 10,82 (.426) | — | 6,84 (.269) | 0,99 (.039) |

Coaxial Straight — Standard PC Tails (Sizes DE-DC)

Receptacle



Reader's Resource

For contact cavity arrangements, see page 223.
 For P.C. hole patterns, see pages 241-242.
 For panel cutouts, see page 221.
 For alternate 50 Ohm coaxial configuration, see page 225.

75 Ohm Part Numbers* with Standoff #4-40 UNC

| Shell Size | Layout | Part Number Without Screw Locks Without Boardlocks | Part Number Without Screw Locks With Boardlocks | Part Number With Screw Locks With Boardlocks |
|------------|--------|--|---|--|
| DE | 5W1 | DEM5C1SNA197 | DEMZ5C1SNA197 | DEMN5C1SNA197 |
| DA | 7W2 | DAMV7C2SNA197 | DAMZ7C2SNA197 | DAMN7C2SNA197 |
| DA | 11W1 | DAMV11C1SNA197 | DAMZ11C1SNA197 | DAMN11C1SNA197 |
| DA | 3W3 | DAMV3C3SNA197 | DAMZ3C3SNA197 | DAMN3C3SNA197 |
| DA | 3WK3♣ | DAMV3CK3SNA197TM | DAMZ3CK3SNA197TM | DAMN3CK3SNA197TM |
| DB | 5W5 | DBMV5C5SNA197 | DBMZ5C5SNA197 | DBMN5C5SNA197 |
| DB | 9W4 | DBMV9C4SNA197 | DBMZ9C4SNA197 | DBMN9C4SNA197 |
| DB | 13W3 | DBMV13C3SNA197 | DBMZ13C3SNA197 | DBMN13C3SNA197 |
| DB | 17W2 | DBMV17C2SNA197 | DBMZ17C2SNA197 | DBMN17C2SNA197 |
| DB | 21W1 | DBMV21C1SNA197 | DBMZ21C1SNA197 | DBMN21C1SNA197 |
| DC | 8W8 | DCMV8C8SNA197 | DCMZ8C8SNA197 | DCMN8C8SNA197 |
| DC | 13W6 | DCMV13C6SNA197 | DCMZ13C6SNA197 | DCMN13C6SNA197 |
| DC | 17W5 | DCMV17C5SNA197 | DCMZ17C5SNA197 | DCMN17C5SNA197 |
| DC | 21WA4 | DCMV21CA4SNA197 | DCMZ21CA4SNA197 | DCMN21CA4SNA197 |
| DC | 25W3 | DCMV25C3SNA197 | DCMZ25C3SNA197 | DCMN25C3SNA197 |
| DC | 27W2 | DCMV27C2SNA197 | DCMZ27C2SNA197 | DCMN27C2SNA197 |

Notes: * For 50 Ohm Coaxial substitute X for C. Example: DEMV5X1SNA197
 For contacts with 30 microinches gold substitute K126 for A197. Example: DEMN5C1SNK126
 For DD shell sizes, see page 55.
 ♣ Keyed.



Hardware and signal contacts removed for clarity

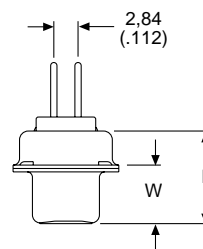

Hardware and coaxial contact removed for clarity

Dimensions

| Shell Size | A | B | C | D | E | F | W | L |
|------------|---------------|---------------|---------------|--------------|--------------|--------------|--------------|--------------|
| | ±0,38 (.015) | ±0,13 (.005) | ±0,13 (.005) | ±0,13 (.005) | ±0,38 (.015) | 0,25 (.010) | ±0,38 (.015) | ±0,25 (.010) |
| DE | 30,81 (1.213) | 16,33 (.643) | 24,99 (.984) | 7,90 (.311) | 12,55 (.494) | 10,90 (.429) | 6,94 (.273) | 0,76 (.030) |
| DA | 39,14 (1.541) | 24,66 (.971) | 33,32 (1.312) | 7,90 (.311) | 12,55 (.494) | 10,90 (.429) | 6,94 (.273) | 0,76 (.030) |
| DB | 53,04 (2.088) | 38,38 (1.511) | 47,04 (1.852) | 7,90 (.311) | 12,55 (.494) | 10,90 (.429) | 6,94 (.273) | 0,76 (.030) |
| DC | 69,32 (2.729) | 54,84 (2.159) | 63,50 (2.500) | 7,90 (.311) | 12,55 (.494) | 10,90 (.429) | 6,94 (.273) | 0,76 (.030) |

Coaxial Straight — Standard PC Tails (Size DD)



75 Ohm Part Numbers* with Standoff #4-40 UNC

| Shell Size | Layout | Part Number Without Screw Locks Without Boardlocks | Part Number Without Screw Locks With Boardlocks | Part Number With Screw Locks With Boardlocks |
|------------|--------|--|---|--|
| DD | 24W7 | DDMV24C7PNK87 | DDMZ24C7PNK87 | DDMN24C7PNK87 |
| DD | 36W4 | DDMV36C4PNK87 | DDMZ36C4PNK87 | DDMN36C4PNK87 |
| DD | 43W2 | DDMV43C2PNK87 | DDMZ43C2PNK87 | DDMN43C2PNK87 |
| DD | 47W1 | DDMV47C1PNK87 | DDMZ47C1PNK87 | DDMN47C1PNK87 |

Notes: * For 50 Ohm Coaxial substitute X for C. Example: DDMV24X7PNK87
 For contacts with 30 microinches gold substitute K127 for K87. Example: DDMN24C7PNK127

Reader's Resource

- For contact cavity arrangements, see page 222.
- For P.C. hole patterns, see page 240.
- For panel cutouts, see page 221.
- For alternate 50 Ohm coaxial configuration, see page 225.



Hardware and signal contacts removed for clarity



Hardware and coaxial contact removed for clarity

Dimensions

| Shell Size | A | B | C | D | E | F | W | L |
|------------|---------------|---------------|---------------|--------------|--------------|--------------|--------------|--------------|
| | ±0.38 (.015) | ±0.13 (.005) | ±0.13 (.005) | ±0.13 (.005) | ±0.38 (.015) | ±0.25 (.010) | ±0.41 (.016) | ±0.25 (.010) |
| DD | 66.93 (2.635) | 52.81 (2.079) | 61.11 (2.406) | 11.07 (.436) | 15.37 (.605) | 10.82 (.426) | 6.84 (.269) | 0.99 (.039) |

Coaxial Straight — Standard PC Tails (Size DD)

Receptacle



75 Ohm Part Numbers* with Standoff #4-40 UNC

| Shell Size | Layout | Part Number Without Screw Locks Without Boardlocks | Part Number Without Screw Locks With Boardlocks | Part Number With Screw Locks With Boardlocks |
|------------|--------|--|---|--|
| DD | 24W7 | DDMV24C7SNA197 | DDMZ24C7SNA197 | DDMN24C7SNA197 |
| DD | 36W4 | DDMV36C4SNA197 | DDMZ36C4SNA197 | DDMN36C4SNA197 |
| DD | 43W2 | DDMV43C2SNA197 | DDMZ43C2SNA197 | DDMN43C2SNA197 |
| DD | 47W1 | DDMV47C1SNA197 | DDMZ47C1SNA197 | DDMN47C1SNA197 |

Notes: * For 50 Ohm Coaxial substitute X for C. Example: DDMV24X7SNA197
For contacts with 30 microinches gold substitute K126 for A197. Example: DDMN24C7SNK126

Reader's Resource

- For contact cavity arrangements, see page 223.
- For P.C. hole patterns, see page 243.
- For panel cutouts, see page 221.
- For alternate 50 Ohm coaxial configuration, see page 225.



Hardware and signal contacts removed for clarity



Hardware and coaxial contact removed for clarity

Dimensions

| Shell Size | A | B | C | D | E | F | W | L |
|------------|---------------|---------------|---------------|--------------|--------------|--------------|--------------|--------------|
| | ±0,38 (.015) | ±0,13 (.005) | ±0,13 (.005) | ±0,13 (.005) | ±0,38 (.015) | ±0,25 (.010) | ±0,38 (.015) | ±0,25 (.010) |
| DD | 66,93 (2.635) | 52,42 (2.064) | 61,11 (2.406) | 10,74 (.423) | 15,37 (.605) | 10,90 (.429) | 6,94 (.273) | 0,76 (.030) |

Coaxial Straight — European PC Tails (Sizes DE-DC)

Plug



75 Ohm Part Numbers* with Standoff #4-40 UNC

| Shell Size | Layout | Part Number Without Screw Locks Without Boardlocks | Part Number Without Screw Locks With Boardlocks | Part Number With Screw Locks With Boardlocks |
|------------|--------|--|---|--|
| DE | 5W1 | DEM5C1PYK87 | DEMZ5C1PYK87 | DEMN5C1PYK87 |
| DA | 7W2 | DAMV7C2PYK87 | DAMZ7C2PYK87 | DAMN7C2PYK87 |
| DA | 11W1 | DAMV11C1PYK87 | DAMZ11C1PYK87 | DAMN11C1PYK87 |
| DA | 3W3 | DAMV3C3PYK87 | DAMZ3C3PYK87 | DAMN3C3PYK87 |
| DA | 3WK3♣ | DAMV3CK3PYK87TM | DAMZ3CK3PYK87TM | DAMN3CK3PYK87TM |
| DB | 5W5 | DBMV5C5PYK87 | DBMZ5C5PYK87 | DBMN5C5PYK87 |
| DB | 9W4 | DBMV9C4PYK87 | DBMZ9C4PYK87 | DBMN9C4PYK87 |
| DB | 13W3 | DBMV13C3PYK87 | DBMZ13C3PYK87 | DBMN13C3PYK87 |
| DB | 17W2 | DBMV17C2PYK87 | DBMZ17C2PYK87 | DBMN17C2PYK87 |
| DB | 21W1 | DBMV21C1PYK87 | DBMZ21C1PYK87 | DBMN21C1PYK87 |
| DC | 8W8 | DCMV8C8PYK87 | DCMZ8C8PYK87 | DCMN8C8PYK87 |
| DC | 13W6 | DCMV13C6PYK87 | DCMZ13C6PYK87 | DCMN13C6PYK87 |
| DC | 17W5 | DCMV17C5PYK87 | DCMZ17C5PYK87 | DCMN17C5PYK87 |
| DC | 21WA4 | DCMV21CA4PYK87 | DCMZ21CA4PYK87 | DCMN21CA4PYK87 |
| DC | 25W3 | DCMV25C3PYK87 | DCMZ25C3PYK87 | DCMN25C3PYK87 |
| DC | 27W2 | DCMV27C2PYK87 | DCMZ27C2PYK87 | DCMN27C2PYK87 |

Reader's Resource

For contact cavity arrangements, see page 222.
 For P.C. hole patterns, see pages 238-239.
 For panel cutouts, see page 221.
 For alternate 50 Ohm coaxial configuration, see page 225.

For M3 threads replace MV with MT, MZ with MQ, MN with MU.
 Notes: * For 50 Ohm Coaxial substitute X for C. Example: DEMV5X1PYK87
 For tin plated PC tails add A226 (signal contacts only). Example: DEMV5C1PYK87A226
 For performance class 2 substitute K127 for K87. Example: DEMV5C1PYK127
 For DD shell sizes, see page 58.
 ♣ Keyed.



Dimensions

| Shell Size | A | B | C | D | E | F | W | W | L |
|------------|---------------|---------------|---------------|--------------|--------------|--------------|----------------|--------------|--------------|
| | ±0,38 (.015) | ±0,13 (.005) | ±0,13 (.005) | ±0,13 (.005) | ±0,38 (.015) | ±0,25 (.010) | ±0,368 (.0145) | ±0,41 (.016) | ±0,25 (.010) |
| DE | 30,81 (1.213) | 16,92 (.666) | 24,99 (.984) | 8,36 (.329) | 12,55 (.494) | 10,72 (.422) | 6,693 (.2635) | — | 0,76 (.030) |
| DA | 39,14 (1.541) | 25,25 (.994) | 33,32 (1.312) | 8,36 (.329) | 12,55 (.494) | 10,72 (.422) | 6,693 (.2635) | — | 0,76 (.030) |
| DB | 53,04 (2.088) | 38,96 (1.534) | 47,04 (1.852) | 8,36 (.329) | 12,55 (.494) | 10,82 (.426) | — | 6,84 (.269) | 0,99 (.039) |
| DC | 69,32 (2.729) | 55,42 (2.182) | 63,50 (2.500) | 8,36 (.329) | 12,55 (.494) | 10,82 (.426) | — | 6,84 (.269) | 0,99 (.039) |

Coaxial Straight — European PC Tails (Sizes DE-DC)

Receptacle



75 Ohm Part Numbers* with Standoff #4-40 UNC

| Shell Size | Layout | Part Number Without Screw Locks Without Boardlocks | Part Number Without Screw Locks With Boardlocks | Part Number With Screw Locks With Boardlocks |
|------------|--------|--|---|--|
| DE | 5W1 | DEM5C1SYA197 | DEM5C1SYA197 | DEMN5C1SYA197 |
| DA | 7W2 | DAMV7C2SYA197 | DAMZ7C2SYA197 | DAMN7C2SYA197 |
| DA | 11W1 | DAMV11C1SYA197 | DAMZ11C1SYA197 | DAMN11C1SYA197 |
| DA | 3W3 | DAMV3C3SYA197 | DAMZ3C3SYA197 | DAMN3C3SYA197 |
| DA | 3WK3♣ | DAMV3CK3SYA197TM | DAMZ3CK3SYA197TM | DAMN3CK3SYA197TM |
| DB | 5W5 | DBMV5C5SYA197 | DBMZ5C5SYA197 | DBMN5C5SYA197 |
| DB | 9W4 | DBMV9C4SYA197 | DBMZ9C4SYA197 | DBMN9C4SYA197 |
| DB | 13W3 | DBMV13C3SYA197 | DBMZ13C3SYA197 | DBMN13C3SYA197 |
| DB | 17W2 | DBMV17C2SYA197 | DBMZ17C2SYA197 | DBMN17C2SYA197 |
| DB | 21W1 | DBMV21C1SYA197 | DBMZ21C1SYA197 | DBMN21C1SYA197 |
| DC | 8W8 | DCMV8C8SYA197 | DCMZ8C8SYA197 | DCMN8C8SYA197 |
| DC | 13W6 | DCMV13C6SYA197 | DCMZ13C6SYA197 | DCMN13C6SYA197 |
| DC | 17W5 | DCMV17C5SYA197 | DCMZ17C5SYA197 | DCMN17C5SYA197 |
| DC | 21WA4 | DCMV21CA4SYA197 | DCMZ21CA4SYA197 | DCMN21CA4SYA197 |
| DC | 25W3 | DCMV25C3SYA197 | DCMZ25C3SYA197 | DCMN25C3SYA197 |
| DC | 27W2 | DCMV27C2SYA197 | DCMZ27C2SYA197 | DCMN27C2SYA197 |

Reader's Resource

For contact cavity arrangements, see page 223.
 For P.C. hole patterns, see pages 241-242.
 For alternate 50 Ohm coaxial configuration, see page 225.

For M3 threads replace MV with MT, MZ with MQ, MN with MU.
 Notes: * For 50 Ohm Coaxial substitute X for C. Example: DEMV5X1SYA197
 For performance class 2 substitute K126 for A197. Example: DEMV5C1SYK126
 For DD shell sizes, see page 59.
 ♣ Keyed.



Hardware and signal contacts removed for clarity



Hardware and coaxial contact removed for clarity

Dimensions

| Shell Size | A | B | C | D | E | F | W | L |
|------------|---------------|---------------|---------------|--------------|--------------|--------------|--------------|--------------|
| | ±0.38 (.015) | ±0.13 (.005) | ±0.13 (.005) | ±0.13 (.005) | ±0.38 (.015) | ±0.25 (.010) | ±0.38 (.015) | ±0.25 (.010) |
| DE | 30.81 (1.213) | 16.33 (.643) | 24.99 (.984) | 7.90 (.311) | 12.55 (.494) | 10.90 (.429) | 6.94 (.273) | 0.76 (.030) |
| DA | 39.14 (1.541) | 24.66 (.971) | 33.32 (1.312) | 7.90 (.311) | 12.55 (.494) | 10.90 (.429) | 6.94 (.273) | 0.76 (.030) |
| DB | 53.04 (2.088) | 38.38 (1.511) | 47.04 (1.852) | 7.90 (.311) | 12.55 (.494) | 10.90 (.429) | 6.94 (.273) | 0.76 (.030) |
| DC | 69.32 (2.729) | 54.84 (2.159) | 63.50 (2.500) | 7.90 (.311) | 12.55 (.494) | 10.90 (.429) | 6.94 (.273) | 0.76 (.030) |

Coaxial Straight — European PC Tails (Size DD)

Plug



75 Ohm Part Numbers* with Standoff #4-40 UNC

| Shell Size | Layout | Part Number Without Screw Locks Without Boardlocks | Part Number Without Screw Locks With Boardlocks | Part Number With Screw Locks With Boardlocks |
|------------|--------|--|---|--|
| DD | 24W7 | DDMV24C7PYK87 | DDMZ24C7PYK87 | DDMN24C7PYK87 |
| DD | 36W4 | DDMV36C4PYK87 | DDMZ36C4PYK87 | DDMN36C4PYK87 |
| DD | 43W2 | DDMV43C2PYK87 | DDMZ43C2PYK87 | DDMN43C2PYK87 |
| DD | 47W1 | DDMV47C1PYK87 | DDMZ47C1PYK87 | DDMN47C1PYK87 |

For M3 threads replace MV with MT, MZ with MQ, MN with MU.
 Notes: * For 50 Ohm Coaxial substitute X for C. Example: DDMV24X7PYK87
 For tin plated PC tails add A226 (signal contacts only). Example: DDMV24C7PYK87A226
 For performance class 2 substitute K127 for K87. Example: DDMV24C7PYK127

Reader's Resource

- For contact cavity arrangements, see page 222.
- For P.C. hole patterns, see page 240.
- For panel cutouts, see page 221.
- For alternate 50 Ohm coaxial configuration, see page 225.



Hardware and signal contacts removed for clarity



Hardware and coaxial contact removed for clarity

Dimensions

| Shell Size | A | B | C | D | E | F | W | L |
|------------|---------------|---------------|---------------|--------------|--------------|--------------|--------------|--------------|
| | ±0,38 (.015) | ±0,13 (.005) | ±0,13 (.005) | ±0,13 (.005) | ±0,38 (.015) | ±0,25 (.010) | ±0,41 (.016) | ±0,25 (.010) |
| DD | 66,93 (2.635) | 52,81 (2.079) | 61,11 (2.406) | 11,07 (.436) | 15,37 (.605) | 10,82 (.426) | 6,84 (.269) | 0,99 (.039) |

Coaxial Straight — European PC Tails (Size DD)

Receptacle



75 Ohm Part Numbers* with Standoff #4-40 UNC

| Shell Size | Layout | Part Number Without Screw Locks Without Boardlocks | Part Number Without Screw Locks With Boardlocks | Part Number With Screw Locks With Boardlocks |
|------------|--------|--|---|--|
| DD | 24W7 | DDMV24C7SYA197 | DDMZ24C7SYA197 | DDMN24C7SYA197 |
| DD | 36W4 | DDMV36C4SYA197 | DDMZ36C4SYA197 | DDMN36C4SYA197 |
| DD | 43W2 | DDMV43C2SYA197 | DDMZ43C2SYA197 | DDMN43C2SYA197 |
| DD | 47W1 | DDMV47C1SYA197 | DDMZ47C1SYA197 | DDMN47C1SYA197 |

For M3 threads replace MV with MT, MZ with MQ, MN with MU.
 Notes: * For 50 Ohm Coaxial substitute X for C. Example: DDMV24X7SYA197
 For performance class 2 substitute K126 for A197. Example: DDMV24C7SYK126

Reader's Resource

- For contact cavity arrangements, see page 223.
- For P.C. hole patterns, see page 243.
- For panel cutouts, see page 221.
- For alternate 50 Ohm coaxial configuration, see page 225.



Hardware and signal contacts removed for clarity



Hardware and coaxial contact removed for clarity

Dimensions

| Shell Size | A | B | C | D | E | F | W | L |
|------------|---------------|---------------|---------------|--------------|--------------|--------------|--------------|--------------|
| | ±0,38 (.015) | ±0,13 (.005) | ±0,13 (.005) | ±0,13 (.005) | ±0,38 (.015) | ±0,25 (.010) | ±0,38 (.015) | ±0,25 (.010) |
| DD | 66,93 (2.635) | 52,42 (2.064) | 61,11 (2.406) | 10,74 (.423) | 15,37 (.605) | 10,90 (.429) | 6,94 (.273) | 0,76 (.030) |

40 A High Power 90° — Standard Footprint .489♦ or .454 inch♦♦ (Sizes DE-DC)



Reader's Resource

For contact cavity arrangements, see page 222.
 For P.C. hole patterns, see pages 244-245.
 For panel cutouts, see page 221.
 For alternate bracket configuration (when connectors are supplied without boardlocks), see page 226.

Part Numbers with Metal Bracket and Rivnut #4-40 UNC

| Shell Size | Layout | Part Number Without Screw Locks Without Boardlocks | Part Number Without Screw Locks With Boardlocks | Part Number With Screw Locks Without Boardlocks | Part Number With Screw Locks With Boardlocks |
|------------|--------|--|---|---|--|
| DE | 5W1 | DEMP5H1PJK87 | DEMC5H1PJK87 | DEMD5H1PJK87 | DEMG5H1PJK87 |
| DA | 7W2 | DAMP7H2PJK87 | DAMC7H2PJK87 | DAMD7H2PJK87 | DAMG7H2PJK87 |
| DA | 11W1 | DAMP11H1PJK87 | DAMC11H1PJK87 | DAMD11H1PJK87 | DAMG11H1PJK87 |
| DA | 3W3 | DAMP3H3PJK87 | DAMC3H3PJK87 | DAMD3H3PJK87 | DAMG3H3PJK87 |
| DA | 3WK3♣ | DAMP3HK3PJK87TM | DAMC3HK3PJK87TM | DAMD3HK3PJK87TM | DAMG3HK3PJK87TM |
| DB | 5W5 | DBMP5H5PJK87 | DBMC5H5PJK87 | DBMD5H5PJK87 | DBMG5H5PJK87 |
| DB | 9W4 | DBMP9H4PJK87 | DBMC9H4PJK87 | DBMD9H4PJK87 | DBMG9H4PJK87 |
| DB | 13W3 | DBMP13H3PJK87 | DBMC13H3PJK87 | DBMD13H3PJK87 | DBMG13H3PJK87 |
| DB | 17W2 | DBMP17H2PJK87 | DBMC17H2PJK87 | DBMD17H2PJK87 | DBMG17H2PJK87 |
| DB | 21W1 | DBMP21H1PJK87 | DBMC21H1PJK87 | DBMD21H1PJK87 | DBMG21H1PJK87 |
| DC | 8W8 | DCMP8H8PJK87 | DCMC8H8PJK87 | DCMD8H8PJK87 | DCMG8H8PJK87 |
| DC | 13W6 | DCMP13H6PJK87 | DCMC13H6PJK87 | DCMD13H6PJK87 | DCMG13H6PJK87 |
| DC | 17W5 | DCMP17H5PJK87 | DCMC17H5PJK87 | DCMD17H5PJK87 | DCMG17H5PJK87 |
| DC | 21WA4 | DCMP21HA4PJK87 | DCMC21HA4PJK87 | DCMD21HA4PJK87 | DCMG21HA4PJK87 |
| DC | 25W3 | DCMP25H3PJK87 | DCMC25H3PJK87 | DCMD25H3PJK87 | DCMG25H3PJK87 |
| DC | 27W2 | DCMP27H2PJK87 | DCMC27H2PJK87 | DCMD27H2PJK87 | DCMG27H2PJK87 |

Note: For contacts with 30 microinches gold substitute K127 for K87. Example: DEMP5H1PJK127
 For DD shell sizes, see page 62.
 ♣ Keyed.



Screw lock, boardlock, and signal contacts removed for clarity



Screw lock, boardlock, and high power contact removed for clarity

Note: ♥ Dimension varies with alternate bracket configuration, see Reader's Resource page 226.

Dimensions

| Shell Size | A | B | C | D | E | F | W | W | L |
|------------|---------------|---------------|---------------|--------------|--------------|--------------|----------------|--------------|--------------|
| | ±0,38 (.015) | ±0,13 (.005) | ±0,13 (.005) | ±0,13 (.005) | ±0,38 (.015) | ±0,25 (.010) | ±0,368 (.0145) | ±0,41 (.016) | ±0,25 (.010) |
| DE | 30,81 (1.213) | 16,92 (.666) | 24,99 (.984) | 8,36 (.329) | 12,55 (.494) | 10,72 (.422) | 6,693 (.2635) | — | 0,76 (.030) |
| DA | 39,14 (1.541) | 25,25 (.994) | 33,32 (1.312) | 8,36 (.329) | 12,55 (.494) | 10,72 (.422) | 6,693 (.2635) | — | 0,76 (.030) |
| DB | 53,04 (2.088) | 38,96 (1.534) | 47,04 (1.852) | 8,36 (.329) | 12,55 (.494) | 10,82 (.426) | — | 6,84 (.269) | 0,99 (.039) |
| DC | 69,32 (2.729) | 55,42 (2.182) | 63,50 (2.500) | 8,36 (.329) | 12,55 (.494) | 10,82 (.426) | — | 6,84 (.269) | 0,99 (.039) |

- ♦ Connector footprint measured from the front shell.
- ♦♦ Connector footprint measured from the rear shell.

40 A High Power 90° — Standard Footprint .489♦ or .454 inch♦♦ (Sizes DE-DC)

Receptacle



Reader's Resource

For contact cavity arrangements, see page 223.
 For P.C. hole patterns, see pages 247-248.
 For panel cutouts, see page 221.
 For alternate bracket configuration (when connectors are supplied without boardlocks), see page 226.

Part Numbers with Metal Bracket and Rivnut #4-40 UNC

| Shell Size | Layout | Part Number Without Screw Locks Without Boardlocks | Part Number Without Screw Locks With Boardlocks | Part Number With Screw Locks Without Boardlocks | Part Number With Screw Locks With Boardlocks |
|------------|--------|--|---|---|--|
| DE | 5W1 | DEMP5H1SJA197 | DEMC5H1SJA197 | DEMD5H1SJA197 | DEMG5H1SJA197 |
| DA | 7W2 | DAMP7H2SJA197 | DAMC7H2SJA197 | DAMD7H2SJA197 | DAMG7H2SJA197 |
| DA | 11W1 | DAMP11H1SJA197 | DAMC11H1SJA197 | DAMD11H1SJA197 | DAMG11H1SJA197 |
| DA | 3W3 | DAMP3H3SJA197 | DAMC3H3SJA197 | DAMD3H3SJA197 | DAMG3H3SJA197 |
| DA | 3WK3♣ | DAMP3HK3SJA197TM | DAMC3HK3SJA197TM | DAMD3HK3SJA197TM | DAMG3HK3SJA197TM |
| DB | 5W5 | DBMP5H5SJA197 | DBMC5H5SJA197 | DBMD5H5SJA197 | DBMG5H5SJA197 |
| DB | 9W4 | DBMP9H4SJA197 | DBMC9H4SJA197 | DBMD9H4SJA197 | DBMG9H4SJA197 |
| DB | 13W3 | DBMP13H3SJA197 | DBMC13H3SJA197 | DBMD13H3SJA197 | DBMG13H3SJA197 |
| DB | 17W2 | DBMP17H2SJA197 | DBMC17H2SJA197 | DBMD17H2SJA197 | DBMG17H2SJA197 |
| DB | 21W1 | DBMP21H1SJA197 | DBMC21H1SJA197 | DBMD21H1SJA197 | DBMG21H1SJA197 |
| DC | 8W8 | DCMP8H8SJA197 | DCMC8H8SJA197 | DCMD8H8SJA197 | DCMG8H8SJA197 |
| DC | 13W6 | DCMP13H6SJA197 | DCMC13H6SJA197 | DCMD13H6SJA197 | DCMG13H6SJA197 |
| DC | 17W5 | DCMP17H5SJA197 | DCMC17H5SJA197 | DCMD17H5SJA197 | DCMG17H5SJA197 |
| DC | 21WA4 | DCMP21HA4SJA197 | DCMC21HA4SJA197 | DCMD21HA4SJA197 | DCMG21HA4SJA197 |
| DC | 25W3 | DCMP25H3SJA197 | DCMC25H3SJA197 | DCMD25H3SJA197 | DCMG25H3SJA197 |
| DC | 27W2 | DCMP27H2SJA197 | DCMC27H2SJA197 | DCMD27H2SJA197 | DCMG27H2SJA197 |

Note: For contacts with 30 microinches of gold substitute K126 for A197. Example: DEMP5H1SJK126
 For DD shell sizes, see page 63.
 ♣ Keyed.



Note: ♥ Dimension varies with alternate bracket configuration, see Reader's Resource page 226.

Dimensions

| Shell Size | A | B | C | D | E | F | W | L |
|------------|---------------|---------------|---------------|--------------|--------------|--------------|--------------|--------------|
| | ±0,38 (.015) | ±0,13 (.005) | ±0,13 (.005) | ±0,13 (.005) | ±0,38 (.015) | ±0,25 (.010) | ±0,38 (.015) | ±0,25 (.010) |
| DE | 30,81 (1.213) | 16,33 (.643) | 24,99 (.984) | 7,90 (.311) | 12,55 (.494) | 10,90 (.429) | 6,94 (.273) | 0,76 (.030) |
| DA | 39,14 (1.541) | 24,66 (.971) | 33,32 (1.312) | 7,90 (.311) | 12,55 (.494) | 10,90 (.429) | 6,94 (.273) | 0,76 (.030) |
| DB | 53,04 (2.088) | 38,38 (1.511) | 47,04 (1.852) | 7,90 (.311) | 12,55 (.494) | 10,90 (.429) | 6,94 (.273) | 0,76 (.030) |
| DC | 69,32 (2.729) | 54,84 (2.159) | 63,50 (2.500) | 7,90 (.311) | 12,55 (.494) | 10,90 (.429) | 6,94 (.273) | 0,76 (.030) |

- ♥ Connector footprint measured from the front shell.
- ♦♦ Connector footprint measured from the rear shell.

40 A High Power 90° — Standard Footprint .489♦ or .454 inch♦♦ (Size DD)

Plug



Part Numbers with Metal Bracket and Rivnut #4-40 UNC

| Shell Size | Layout | Part Number Without Screw Locks Without Boardlocks | Part Number Without Screw Locks With Boardlocks | Part Number With Screw Locks Without Boardlocks | Part Number With Screw Locks With Boardlocks |
|------------|--------|--|---|---|--|
| DD | 24W7 | DDMP24H7PJK87 | DDMC24H7PJK87 | DDMD24H7PJK87 | DDMG24H7PJK87 |
| DD | 36W4 | DDMP36H4PJK87 | DDMC36H4PJK87 | DDMD36H4PJK87 | DDMG36H4PJK87 |
| DD | 43W2 | DDMP43H2PJK87 | DDMC43H2PJK87 | DDMD43H2PJK87 | DDMG43H2PJK87 |
| DD | 47W1 | DDMP47H1PJK87 | DDMC47H1PJK87 | DDMD47H1PJK87 | DDMG47H1PJK87 |

Note: For contacts with 30 microinches gold substitute K127 for K87. Example: DDMP24H7PJK127

Reader's Resource

- For contact cavity arrangements, see page 222.
- For P.C. hole patterns, see page 246.
- For panel cutouts, see page 221.
- For alternate bracket configuration (when connectors are supplied without boardlocks), see page 226.



Note: ♥ Dimension varies with alternate bracket configuration, see Reader's Resource page 226.

Dimensions

| Shell Size | A | B | C | D | E | F | W | L |
|------------|---------------|---------------|---------------|--------------|--------------|--------------|--------------|--------------|
| | ±0,38 (.015) | ±0,13 (.005) | ±0,13 (.005) | ±0,13 (.005) | ±0,38 (.015) | ±0,25 (.010) | ±0,41 (.016) | ±0,25 (.010) |
| DD | 66,93 (2.635) | 52,81 (2.079) | 61,11 (2.406) | 11,07 (.436) | 15,37 (.605) | 10,82 (.426) | 6,84 (.269) | 0,99 (.039) |

- ♦ Connector footprint measured from the front shell.
- ♦♦ Connector footprint measured from the rear shell.

40 A High Power 90° — Standard Footprint .489♦ or .454 inch♦♦ (Size DD)

Receptacle



Part Numbers with Metal Bracket and Rivnut #4-40 UNC

| Shell Size | Layout | Part Number Without Screw Locks Without Boardlocks | Part Number Without Screw Locks With Boardlocks | Part Number With Screw Locks Without Boardlocks | Part Number With Screw Locks With Boardlocks |
|------------|--------|--|---|---|--|
| DD | 24W7 | DDMP24H7SJA197 | DDMC24H7SJA197 | DDMD24H7SJA197 | DDMG24H7SJA197 |
| DD | 36W4 | DDMP36H4SJA197 | DDMC36H4SJA197 | DDMD36H4SJA197 | DDMG36H4SJA197 |
| DD | 43W2 | DDMP43H2SJA197 | DDMC43H2SJA197 | DDMD43H2SJA197 | DDMG43H2SJA197 |
| DD | 47W1 | DDMP47H1SJA197 | DDMC47H1SJA197 | DDMD47H1SJA197 | DDMG47H1SJA197 |

Note: For contacts with 30 microinches gold substitute K126 for A197. Example: DDMP24H7SJK126

Reader's Resource

- For contact cavity arrangements, see page 223.
- For P.C. hole patterns, see page 249.
- For panel cutouts, see page 221.
- For alternate bracket configuration (when connectors are supplied without boardlocks), see page 226.



Note: ♥ Dimension varies with alternate bracket configuration, see page 226.

Dimensions

| Shell Size | A ±0,38 (.015) | B ±0,13 (.005) | C ±0,13 (.005) | D ±0,13 (.005) | E ±0,38 (.015) | F ±0,25 (.010) | W ±0,38 (.015) | L ±0,25 (.010) |
|------------|-------------------|-------------------|-------------------|-------------------|-------------------|-------------------|-------------------|-------------------|
| DD | 66,93 (2.635) | 52,42 (2.064) | 61,11 (2.406) | 10,74 (.423) | 15,37 (.605) | 10,90 (.429) | 6,94 (.273) | 0,76 (.030) |

- ♦ Connector footprint measured from the front shell.
- ♦♦ Connector footprint measured from the rear shell.

40 A High Power 90° — European Footprint 10,2♦ or 9,4 mm♦♦ (Sizes DE-DC)

Plug



Reader's Resource

For contact cavity arrangements, see page 222.
 For P.C. hole patterns, see pages 250-251.
 For panel cutouts, see page 221.
 For alternate bracket configuration (when connectors are supplied without boardlocks), see page 226.

Part Numbers with Metal Bracket and Rivnut #4-40 UNC

| Shell Size | Layout | Part Number Without Screw Locks Without Boardlocks | Part Number Without Screw Locks With Boardlocks | Part Number With Screw Locks Without Boardlocks | Part Number With Screw Locks With Boardlocks |
|------------|--------|--|---|---|--|
| DE | 5W1 | DEMP5P1PVK87 | DEMC5P1PVK87 | DEMD5P1PVK87 | DEMG5P1PVK87 |
| DA | 7W2 | DAMP7P2PVK87 | DAMC7P2PVK87 | DAMD7P2PVK87 | DAMG7P2PVK87 |
| DA | 11W1 | DAMP11P1PVK87 | DAMC11P1PVK87 | DAMD11P1PVK87 | DAMG11P1PVK87 |
| DA | 3W3 | DAMP3P3PVK87 | DAMC3P3PVK87 | DAMD3P3PVK87 | DAMG3P3PVK87 |
| DA | 3WK3♣ | DAMP3PK3PVK87TM | DAMC3PK3PVK87TM | DAMD3PK3PVK87TM | DAMG3PK3PVK87TM |
| DB | 5W5 | DBMP5P5PVK87 | DBMC5P5PVK87 | DBMD5P5PVK87 | DBMG5P5PVK87 |
| DB | 9W4 | DBMP9P4PVK87 | DBMC9P4PVK87 | DBMD9P4PVK87 | DBMG9P4PVK87 |
| DB | 13W3 | DBMP13P3PVK87 | DBMC13P3PVK87 | DBMD13P3PVK87 | DBMG13P3PVK87 |
| DB | 17W2 | DBMP17P2PVK87 | DBMC17P2PVK87 | DBMD17P2PVK87 | DBMG17P2PVK87 |
| DB | 21W1 | DBMP21P1PVK87 | DBMC21P1PVK87 | DBMD21P1PVK87 | DBMG21P1PVK87 |
| DC | 8W8 | DCMP8P8PVK87 | DCMC8P8PVK87 | DCMD8P8PVK87 | DCMG8P8PVK87 |
| DC | 13W6 | DCMP13P6PVK87 | DCMC13P6PVK87 | DCMD13P6PVK87 | DCMG13P6PVK87 |
| DC | 17W5 | DCMP17P5PVK87 | DCMC17P5PVK87 | DCMD17P5PVK87 | DCMG17P5PVK87 |
| DC | 21WA4 | DCMP21PA4PVK87 | DCMC21PA4PVK87 | DCMD21PA4PVK87 | DCMG21PA4PVK87 |
| DC | 25W3 | DCMP25P3PVK87 | DCMC25P3PVK87 | DCMD25P3PVK87 | DCMG25P3PVK87 |
| DC | 27W2 | DCMP27P2PVK87 | DCMC27P2PVK87 | DCMD27P2PVK87 | DCMG27P2PVK87 |

For M3 threads replace MP with MS, MC with ML, MD with MO, MG with MJ.
 Notes: For tin plated PC tails add A226 (signal contacts only). Example DEMP5P1PVK87A226
 For performance class 2 substitute K127 for K87. Example: DEMP5P1PVK127
 ♣ Keyed.



Screw lock, boardlock, and signal contacts removed for clarity



Screw lock, boardlock, and high power contact removed for clarity

Note: ♥ Dimension varies with alternate bracket configuration, see Reader's Resource page 226.

Dimensions

| Shell Size | A | B | C | D | E | F | W | W | L |
|------------|---------------|---------------|---------------|--------------|--------------|--------------|----------------|--------------|--------------|
| | ±0,38 (.015) | ±0,13 (.005) | ±0,13 (.005) | ±0,13 (.005) | ±0,38 (.015) | ±0,25 (.010) | ±0,368 (.0145) | ±0,41 (.016) | ±0,25 (.010) |
| DE | 30,81 (1.213) | 16,92 (.666) | 24,99 (.984) | 8,36 (.329) | 12,55 (.494) | 10,72 (.422) | 6,693 (.2635) | — | 0,76 (.030) |
| DA | 39,14 (1.541) | 25,25 (.994) | 33,32 (1.312) | 8,36 (.329) | 12,55 (.494) | 10,72 (.422) | 6,693 (.2635) | — | 0,76 (.030) |
| DB | 53,04 (2.088) | 38,96 (1.534) | 47,04 (1.852) | 8,36 (.329) | 12,55 (.494) | 10,82 (.426) | — | 6,84 (.269) | 0,99 (.039) |
| DC | 69,32 (2.729) | 55,42 (2.182) | 63,50 (2.500) | 8,36 (.329) | 12,55 (.494) | 10,82 (.426) | — | 6,84 (.269) | 0,99 (.039) |

- ♦ Connector footprint measured from the front shell.
- ♦♦ Connector footprint measured from the rear shell.

40 A High Power 90° — European Footprint 10,2♦ or 9,4 mm♦♦ (Sizes DE-DC)

Receptacle



Reader's Resource

For contact cavity arrangements, see page 223.
 For P.C. hole patterns, see pages 252-253.
 For panel cutouts, see page 221.
 For alternate bracket configuration (when connectors are supplied without boardlocks), see page 226.

Part Numbers with Metal Bracket and Rivnut #4-40 UNC

| Shell Size | Layout | Part Number Without Screw Locks Without Boardlocks | Part Number Without Screw Locks With Boardlocks | Part Number With Screw Locks Without Boardlocks | Part Number With Screw Locks With Boardlocks |
|------------|--------|--|---|---|--|
| DE | 5W1 | DEMP5P1SVA197 | DEMC5P1SVA197 | DEMD5P1SVA197 | DEMG5P1SVA197 |
| DA | 7W2 | DAMP7P2SVA197 | DAMC7P2SVA197 | DAMD7P2SVA197 | DAMG7P2SVA197 |
| DA | 11W1 | DAMP11P1SVA197 | DAMC11P1SVA197 | DAMD11P1SVA197 | DAMG11P1SVA197 |
| DA | 3W3 | DAMP3P3SVA197 | DAMC3P3SVA197 | DAMD3P3SVA197 | DAMG3P3SVA197 |
| DA | 3WK3♣ | DAMP3PK3SVA197TM | DAMC3PK3SVA197TM | DAMD3PK3SVA197TM | DAMG3PK3SVA197TM |
| DB | 5W5 | DBMP5P5SVA197 | DBMC5P5SVA197 | DBMD5P5SVA197 | DBMG5P5SVA197 |
| DB | 9W4 | DBMP9P4SVA197 | DBMC9P4SVA197 | DBMD9P4SVA197 | DBMG9P4SVA197 |
| DB | 13W3 | DBMP13P3SVA197 | DBMC13P3SVA197 | DBMD13P3SVA197 | DBMG13P3SVA197 |
| DB | 17W2 | DBMP17P2SVA197 | DBMC17P2SVA197 | DBMD17P2SVA197 | DBMG17P2SVA197 |
| DB | 21W1 | DBMP21P1SVA197 | DBMC21P1SVA197 | DBMD21P1SVA197 | DBMG21P1SVA197 |
| DC | 8W8 | DCMP8P8SVA197 | DCMC8P8SVA197 | DCMD8P8SVA197 | DCMG8P8SVA197 |
| DC | 13W6 | DCMP13P6SVA197 | DCMC13P6SVA197 | DCMD13P6SVA197 | DCMG13P6SVA197 |
| DC | 17W5 | DCMP17P5SVA197 | DCMC17P5SVA197 | DCMD17P5SVA197 | DCMG17P5SVA197 |
| DC | 21WA4 | DCMP21PA4SVA197 | DCMC21PA4SVA197 | DCMD21PA4SVA197 | DCMG21PA4SVA197 |
| DC | 25W3 | DCMP25P3SVA197 | DCMC25P3SVA197 | DCMD25P3SVA197 | DCMG25P3SVA197 |
| DC | 27W2 | DCMP27P2SVA197 | DCMC27P2SVA197 | DCMD27P2SVA197 | DCMG27P2SVA197 |

For M3 threads replace MP with MS, MC with ML, MD with MO, MG with MJ.
 Notes: For performance class 2 substitute K126 for A197. Example: DEMP5P1SVK126
 ♣ Keyed.



Screw lock, boardlock, and signal contacts removed for clarity



Screw lock, boardlock, and high power contact removed for clarity

Note: ♥ Dimension varies with alternate bracket configuration, see Reader's Resource page 226.

Dimensions

| Shell Size | A ±0,38 (.015) | B ±0,13 (.005) | C ±0,13 (.005) | D ±0,13 (.005) | E ±0,38 (.015) | F ±0,25 (.010) | W ±0,38 (.015) | L ±0,25 (.010) |
|------------|----------------|----------------|----------------|----------------|----------------|----------------|----------------|----------------|
| DE | 30,81 (1.213) | 16,33 (.643) | 24,99 (.984) | 7,90 (.311) | 12,55 (.494) | 10,90 (.429) | 6,94 (.273) | 0,76 (.030) |
| DA | 39,14 (1.541) | 24,66 (.971) | 33,32 (1.312) | 7,90 (.311) | 12,55 (.494) | 10,90 (.429) | 6,94 (.273) | 0,76 (.030) |
| DB | 53,04 (2.088) | 38,38 (1.511) | 47,04 (1.852) | 7,90 (.311) | 12,55 (.494) | 10,90 (.429) | 6,94 (.273) | 0,76 (.030) |
| DC | 69,32 (2.729) | 54,84 (2.159) | 63,50 (2.500) | 7,90 (.311) | 12,55 (.494) | 10,90 (.429) | 6,94 (.273) | 0,76 (.030) |

- ♦ Connector footprint measured from the front shell.
- ♦♦ Connector footprint measured from the rear shell.

40 A High Power Straight — Standard PC Tails (Sizes DE-DC)

Plug



Reader's Resource

For contact cavity arrangements, see page 222.
 For P.C. hole patterns, see pages 254-255.
 For panel cutouts, see page 221.

Part Numbers with Standoff #4-40 UNC

| Shell Size | Layout | Part Number Without Screw Locks Without Boardlocks | Part Number Without Screw Locks With Boardlocks | Part Number With Screw Locks With Boardlocks |
|------------|--------|--|---|--|
| DE | 5W1 | DEM5V5H1PNK87 | DEM25H1PNK87 | DEMN5H1PNK87 |
| DA | 7W2 | DAMV7H2PNK87 | DAMZ7H2PNK87 | DAMN7H2PNK87 |
| DA | 11W1 | DAMV11H1PNK87 | DAMZ11H1PNK87 | DAMN11H1PNK87 |
| DA | 3W3 | DAMV3H3PNK87 | DAMZ3H3PNK87 | DAMN3H3PNK87 |
| DA | 3WK3♣ | DAMV3HK3PNK87TM | DAMZ3HK3PNK87TM | DAMN3HK3PNK87TM |
| DB | 5W5 | DBMV5H5PNK87 | DBMZ5H5PNK87 | DBMN5H5PNK87 |
| DB | 9W4 | DBMV9H4PNK87 | DBMZ9H4PNK87 | DBMN9H4PNK87 |
| DB | 13W3 | DBMV13H3PNK87 | DBMZ13H3PNK87 | DBMN13H3PNK87 |
| DB | 17W2 | DBMV17H2PNK87 | DBMZ17H2PNK87 | DBMN17H2PNK87 |
| DB | 21W1 | DBMV21H1PNK87 | DBMZ21H1PNK87 | DBMN21H1PNK87 |
| DC | 8W8 | DCMV8H8PNK87 | DCMZ8H8PNK87 | DCMN8H8PNK87 |
| DC | 13W6 | DCMV13H6PNK87 | DCMZ13H6PNK87 | DCMN13H6PNK87 |
| DC | 17W5 | DCMV17H5PNK87 | DCMZ17H5PNK87 | DCMN17H5PNK87 |
| DC | 21WA4 | DCMV21HA4PNK87 | DCMZ21HA4PNK87 | DCMN21HA4PNK87 |
| DC | 25W3 | DCMV25H3PNK87 | DCMZ25H3PNK87 | DCMN25H3PNK87 |
| DC | 27W2 | DCMV27H2PNK87 | DCMZ27H2PNK87 | DCMN27H2PNK87 |

Note: For contacts with 30 microinches gold substitute K127 for K87. Example: DEMV5H1PNK127
 For DD shell sizes, see page 68.
 ♣ Keyed.



Screw lock, boardlock and high power contact removed for clarity

Dimensions

| Shell Size | A | B | C | D | E | F | W | W | L |
|------------|---------------|---------------|---------------|--------------|--------------|--------------|----------------|--------------|--------------|
| | ±0,38 (.015) | ±0,13 (.005) | ±0,13 (.005) | ±0,13 (.005) | ±0,38 (.015) | ±0,25 (.010) | ±0,368 (.0145) | ±0,41 (.016) | ±0,25 (.010) |
| DE | 30,81 (1.213) | 16,92 (.666) | 24,99 (.984) | 8,36 (.329) | 12,55 (.494) | 10,72 (.422) | 6,693 (.2635) | — | 0,76 (.030) |
| DA | 39,14 (1.541) | 25,25 (.994) | 33,32 (1.312) | 8,36 (.329) | 12,55 (.494) | 10,72 (.422) | 6,693 (.2635) | — | 0,76 (.030) |
| DB | 53,04 (2.088) | 38,96 (1.534) | 47,04 (1.852) | 8,36 (.329) | 12,55 (.494) | 10,82 (.426) | — | 6,84 (.269) | 0,99 (.039) |
| DC | 69,32 (2.729) | 55,42 (2.182) | 63,50 (2.500) | 8,36 (.329) | 12,55 (.494) | 10,82 (.426) | — | 6,84 (.269) | 0,99 (.039) |

40 A High Power Straight — Standard PC Tails (Sizes DE-DC)

Receptacle



Reader's Resource

For contact cavity arrangements, see page 223.
For P.C. hole patterns, see pages 257-258.
For panel cutouts, see page 221.

Part Numbers with Standoff #4-40 UNC

| Shell Size | Layout | Part Number Without Screw Locks Without Boardlocks | Part Number Without Screw Locks With Boardlocks | Part Number With Screw Locks With Boardlocks |
|------------|--------|--|---|--|
| DE | 5W1 | DEMV5H1SNA197 | DEMZ5H1SNA197 | DEMNS5H1SNA197 |
| DA | 7W2 | DAMV7H2SNA197 | DAMZ7H2SNA197 | DAMNS7H2SNA197 |
| DA | 11W1 | DAMV11H1SNA197 | DAMZ11H1SNA197 | DAMNS11H1SNA197 |
| DA | 3W3 | DAMV3H3SNA197 | DAMZ3H3SNA197 | DAMNS3H3SNA197 |
| DA | 3WK3♣ | DAMV3HK3SNA197TM | DAMZ3HK3SNA197TM | DAMNS3HK3SNA197TM |
| DB | 5W5 | DBMV5H5SNA197 | DBMZ5H5SNA197 | DBMNS5H5SNA197 |
| DB | 9W4 | DBMV9H4SNA197 | DBMZ9H4SNA197 | DBMNS9H4SNA197 |
| DB | 13W3 | DBMV13H3SNA197 | DBMZ13H3SNA197 | DBMNS13H3SNA197 |
| DB | 17W2 | DBMV17H2SNA197 | DBMZ17H2SNA197 | DBMNS17H2SNA197 |
| DB | 21W1 | DBMV21H1SNA197 | DBMZ21H1SNA197 | DBMNS21H1SNA197 |
| DC | 8W8 | DCMV8H8SNA197 | DCMZ8H8SNA197 | DCMNS8H8SNA197 |
| DC | 13W6 | DCMV13H6SNA197 | DCMZ13H6SNA197 | DCMNS13H6SNA197 |
| DC | 17W5 | DCMV17H5SNA197 | DCMZ17H5SNA197 | DCMNS17H5SNA197 |
| DC | 21WA4 | DCMV21HA4SNA197 | DCMZ21HA4SNA197 | DCMNS21HA4SNA197 |
| DC | 25W3 | DCMV25H3SNA197 | DCMZ25H3SNA197 | DCMNS25H3SNA197 |
| DC | 27W2 | DCMV27H2SNA197 | DCMZ27H2SNA197 | DCMNS27H2SNA197 |

Note: For contacts with 30 microinches gold substitute K126 for A197. Example: DEMV5H1SNK126
For DD shell sizes, see page 69.
♣ Keyed.



Dimensions

| Shell Size | A | B | C | D | E | F | W | L |
|------------|---------------|---------------|---------------|--------------|--------------|--------------|--------------|--------------|
| | ±0,38 (.015) | ±0,13 (.005) | ±0,13 (.005) | ±0,13 (.005) | ±0,38 (.015) | ±0,25 (.010) | ±0,38 (.015) | ±0,25 (.010) |
| DE | 30,81 (1.213) | 16,33 (.643) | 24,99 (.984) | 7,90 (.311) | 12,55 (.494) | 10,90 (.429) | 6,94 (.273) | 0,76 (.030) |
| DA | 39,14 (1.541) | 24,66 (.971) | 33,32 (1.312) | 7,90 (.311) | 12,55 (.494) | 10,90 (.429) | 6,94 (.273) | 0,76 (.030) |
| DB | 53,04 (2.088) | 38,38 (1.511) | 47,04 (1.852) | 7,90 (.311) | 12,55 (.494) | 10,90 (.429) | 6,94 (.273) | 0,76 (.030) |
| DC | 69,32 (2.729) | 54,84 (2.159) | 63,50 (2.500) | 7,90 (.311) | 12,55 (.494) | 10,90 (.429) | 6,94 (.273) | 0,76 (.030) |

40 A High Power Straight — Standard PC Tails (Size DD)

Plug



Part Numbers with Standoff #4-40 UNC

| Shell Size | Layout | Part Number Without Screw Locks Without Boardlocks | Part Number Without Screw Locks With Boardlocks | Part Number With Screw Locks With Boardlocks |
|------------|--------|--|---|--|
| DD | 24W7 | DDMV24H7PNK87 | DDMZ24H7PNK87 | DDMN24H7PNK87 |
| DD | 36W4 | DDMV36H4PNK87 | DDMZ36H4PNK87 | DDMN36H4PNK87 |
| DD | 43W2 | DDMV43H2PNK87 | DDMZ43H2PNK87 | DDMN43H2PNK87 |
| DD | 47W1 | DDMV47H1PNK87 | DDMZ47H1PNK87 | DDMN47H1PNK87 |

Note: For contacts with 30 microinches gold substitute K127 for K87. Example: DDMV24H7PNK127

Reader's Resource

For contact cavity arrangements, see page 222.
 For P.C. hole patterns, see page 256.
 For panel cutouts, see page 221.



Dimensions

| Shell Size | A | B | C | D | E | F | W | L |
|------------|---------------|---------------|---------------|--------------|--------------|--------------|--------------|--------------|
| DD | ±0,38 (.015) | ±0,13 (.005) | ±0,13 (.005) | ±0,13 (.005) | ±0,38 (.015) | ±0,25 (.010) | ±0,41 (.016) | ±0,25 (.010) |
| DD | 66,93 (2.635) | 52,81 (2.079) | 61,11 (2.406) | 11,07 (.436) | 15,37 (.605) | 10,82 (.426) | 6,84 (.269) | 0,99 (.039) |

40 A High Power Straight — Standard PC Tails (Size DD)

Receptacle



Part Numbers with Standoff #4-40 UNC

| Shell Size | Layout | Part Number Without Screw Locks Without Boardlocks | Part Number Without Screw Locks With Boardlocks | Part Number With Screw Locks With Boardlocks |
|------------|--------|--|---|--|
| DD | 24W7 | DDMV24H7SNA197 | DDMZ24H7SNA197 | DDMN24H7SNA197 |
| DD | 36W4 | DDMV36H4SNA197 | DDMZ36H4SNA197 | DDMN36H4SNA197 |
| DD | 43W2 | DDMV43H2SNA197 | DDMZ43H2SNA197 | DDMN43H2SNA197 |
| DD | 47W1 | DDMV47H1SNA197 | DDMZ47H1SNA197 | DDMN47H1SNA197 |

Note: For contacts with 30 microinches gold substitute K126 for A197. Example: DDMV24H7SNK126

Reader's Resource

- For contact cavity arrangements, see page 223.
- For P.C. hole patterns, see page 259.
- For panel cutouts, see page 221.



Screw lock, boardlock and high power contact removed for clarity

Dimensions

| Shell Size | A | B | C | D | E | F | W | L |
|------------|---------------|---------------|---------------|--------------|--------------|--------------|--------------|--------------|
| | ±0,38 (.015) | ±0,13 (.005) | ±0,13 (.005) | ±0,13 (.005) | ±0,38 (.015) | ±0,25 (.010) | ±0,38 (.015) | ±0,25 (.010) |
| DD | 66,93 (2.635) | 52,42 (2.064) | 61,11 (2.406) | 10,74 (.423) | 15,37 (.605) | 10,90 (.429) | 6,94 (.273) | 0,76 (.030) |

40 A High Power Straight — European PC Tails (Sizes DE-DC)

Plug



Reader's Resource

For contact cavity arrangements, see page 222.
 For P.C. hole patterns, see pages 254-255.
 For panel cutouts, see page 221.

Part Numbers with Standoff #4-40 UNC

| Shell Size | Layout | Part Number Without Screw Locks Without Boardlocks | Part Number Without Screw Locks With Boardlocks | Part Number With Screw Locks With Boardlocks |
|------------|--------|--|---|--|
| DE | 5W1 | DEM5H1PYK87 | DEMZ5H1PYK87 | DEMN5H1PYK87 |
| DA | 7W2 | DAMV7H2PYK87 | DAMZ7H2PYK87 | DAMN7H2PYK87 |
| DA | 11W1 | DAMV11H1PYK87 | DAMZ11H1PYK87 | DAMN11H1PYK87 |
| DA | 3W3 | DAMV3H3PYK87 | DAMZ3H3PYK87 | DAMN3H3PYK87 |
| DA | 3WK3♣ | DAMV3HK3PYK87TM | DAMZ3HK3PYK87TM | DAMN3HK3PYK87TM |
| DB | 5W5 | DBMV5H5PYK87 | DBMZ5H5PYK87 | DBMN5H5PYK87 |
| DB | 9W4 | DBMV9H4PYK87 | DBMZ9H4PYK87 | DBMN9H4PYK87 |
| DB | 13W3 | DBMV13H3PYK87 | DBMZ13H3PYK87 | DBMN13H3PYK87 |
| DB | 17W2 | DBMV17H2PYK87 | DBMZ17H2PYK87 | DBMN17H2PYK87 |
| DB | 21W1 | DBMV21H1PYK87 | DBMZ21H1PYK87 | DBMN21H1PYK87 |
| DC | 8W8 | DCMV8H8PYK87 | DCMZ8H8PYK87 | DCMN8H8PYK87 |
| DC | 13W6 | DCMV13H6PYK87 | DCMZ13H6PYK87 | DCMN13H6PYK87 |
| DC | 17W5 | DCMV17H5PYK87 | DCMZ17H5PYK87 | DCMN17H5PYK87 |
| DC | 21WA4 | DCMV21HA4PYK87 | DCMZ21HA4PYK87 | DCMN21HA4PYK87 |
| DC | 25W3 | DCMV25H3PYK87 | DCMZ25H3PYK87 | DCMN25H3PYK87 |
| DC | 27W2 | DCMV27H2PYK87 | DCMZ27H2PYK87 | DCMN27H2PYK87 |

For M3 threads replace MV with MT, MZ with MQ, MN with MU.
 Notes: For tin plated PC tails add A226 (signal contacts only). Example: DEMV5H1PYK87A226
 For performance class 2 substitute K127 for K87. Example: DEMV5H1PYK127
 For DD shell sizes, see page 72.
 ♣ Keyed.



Dimensions

| Shell Size | A | B | C | D | E | F | W | W | L |
|------------|---------------|---------------|---------------|--------------|--------------|--------------|----------------|--------------|--------------|
| | ±0,38 (.015) | ±0,13 (.005) | ±0,13 (.005) | ±0,13 (.005) | ±0,38 (.015) | ±0,25 (.010) | ±0,368 (.0145) | ±0,41 (.016) | ±0,25 (.010) |
| DE | 30,81 (1.213) | 16,92 (.666) | 24,99 (.984) | 8,36 (.329) | 12,55 (.494) | 10,72 (.422) | 6,693 (.2635) | — | 0,76 (.030) |
| DA | 39,14 (1.541) | 25,25 (.994) | 33,32 (1.312) | 8,36 (.329) | 12,55 (.494) | 10,72 (.422) | 6,693 (.2635) | — | 0,76 (.030) |
| DB | 53,04 (2.088) | 38,96 (1.534) | 47,04 (1.852) | 8,36 (.329) | 12,55 (.494) | 10,82 (.426) | — | 6,84 (.269) | 0,99 (.039) |
| DC | 69,32 (2.729) | 55,42 (2.182) | 63,50 (2.500) | 8,36 (.329) | 12,55 (.494) | 10,82 (.426) | — | 6,84 (.269) | 0,99 (.039) |

40 A High Power Straight — European PC Tails (Sizes DE-DC)

Receptacle



Reader's Resource

For contact cavity arrangements, see page 223.
 For P.C. hole patterns, see pages 257-258.
 For panel cutouts, see page 221.

Part Numbers with Standoff #4-40 UNC

| Shell Size | Layout | Part Number Without Screw Locks Without Boardlocks | Part Number Without Screw Locks With Boardlocks | Part Number With Screw Locks With Boardlocks |
|------------|--------|--|---|--|
| DE | 5W1 | DEMV5H1SYA197 | DEMZ5H1SYA197 | DEM5H1SYA197 |
| DA | 7W2 | DAMV7H2SYA197 | DAMZ7H2SYA197 | DAMN7H2SYA197 |
| DA | 11W1 | DAMV11H1SYA197 | DAMZ11H1SYA197 | DAMN11H1SYA197 |
| DA | 3W3 | DAMV3H3SYA197 | DAMZ3H3SYA197 | DAMN3H3SYA197 |
| DA | 3WK3♣ | DAMV3HK3SYA197TM | DAMZ3HK3SYA197TM | DAMN3HK3SYA197TM |
| DB | 5W5 | DBMV5H5SYA197 | DBMZ5H5SYA197 | DBMN5H5SYA197 |
| DB | 9W4 | DBMV9H4SYA197 | DBMZ9H4SYA197 | DBMN9H4SYA197 |
| DB | 13W3 | DBMV13H3SYA197 | DBMZ13H3SYA197 | DBMN13H3SYA197 |
| DB | 17W2 | DBMV17H2SYA197 | DBMZ17H2SYA197 | DBMN17H2SYA197 |
| DB | 21W1 | DBMV21H1SYA197 | DBMZ21H1SYA197 | DBMN21H1SYA197 |
| DC | 8W8 | DCMV8H8SYA197 | DCMZ8H8SYA197 | DCMN8H8SYA197 |
| DC | 13W6 | DCMV13H6SYA197 | DCMZ13H6SYA197 | DCMN13H6SYA197 |
| DC | 17W5 | DCMV17H5SYA197 | DCMZ17H5SYA197 | DCMN17H5SYA197 |
| DC | 21WA4 | DCMV21HA4SYA197 | DCMZ21HA4SYA197 | DCMN21HA4SYA197 |
| DC | 25W3 | DCMV25H3SYA197 | DCMZ25H3SYA197 | DCMN25H3SYA197 |
| DC | 27W2 | DCMV27H2SYA197 | DCMZ27H2SYA197 | DCMN27H2SYA197 |

For M3 threads replace MV with MT, MZ with MQ, MN with MU.
 Notes: For performance class 2 substitute K126 for A197. Example: DEMV5H1SYK126
 For DD shell sizes, see page 73.
 ♣ Keyed.



Dimensions

| Shell Size | A ±0,38 (.015) | B ±0,13 (.005) | C ±0,13 (.005) | D ±0,13 (.005) | E ±0,38 (.015) | F ±0,25 (.010) | W ±0,38 (.015) | L ±0,25 (.010) |
|------------|-------------------|-------------------|-------------------|-------------------|-------------------|-------------------|-------------------|-------------------|
| DE | 30,81 (1.213) | 16,33 (.643) | 24,99 (.984) | 7,90 (.311) | 12,55 (.494) | 10,90 (.429) | 6,94 (.273) | 0,76 (.030) |
| DA | 39,14 (1.541) | 24,66 (.971) | 33,32 (1.312) | 7,90 (.311) | 12,55 (.494) | 10,90 (.429) | 6,94 (.273) | 0,76 (.030) |
| DB | 53,04 (2.088) | 38,38 (1.511) | 47,04 (1.852) | 7,90 (.311) | 12,55 (.494) | 10,90 (.429) | 6,94 (.273) | 0,76 (.030) |
| DC | 69,32 (2.729) | 54,84 (2.159) | 63,50 (2.500) | 7,90 (.311) | 12,55 (.494) | 10,90 (.429) | 6,94 (.273) | 0,76 (.030) |

40 A High Power Straight — European PC Tails (Size DD)

Plug



Part Numbers with Standoff #4-40 UNC

| Shell Size | Layout | Part Number Without Screw Locks Without Boardlocks | Part Number Without Screw Locks With Boardlocks | Part Number With Screw Locks With Boardlocks |
|------------|--------|--|---|--|
| DD | 24W7 | DDMV24H7PYK87 | DDMZ24H7PYK87 | DDMN24H7PYK87 |
| DD | 36W4 | DDMV36H4PYK87 | DDMZ36H4PYK87 | DDMN36H4PYK87 |
| DD | 43W2 | DDMV43H2PYK87 | DDMZ43H2PYK87 | DDMN43H2PYK87 |
| DD | 47W1 | DDMV47H1PYK87 | DDMZ47H1PYK87 | DDMN47H1PYK87 |

For M3 threads replace MV with MT, MZ with MQ, MN with MU.
 Notes: For tin plated PC tails add A226 (signal contacts only). Example DDMV24H7PYK87A226
 For performance class 2 substitute K127 for K87. Example: DDMV24H7PYK127

Reader's Resource

For contact cavity arrangements, see page 222.
 For P.C. hole patterns, see page 256.
 For panel cutouts, see page 221.



Dimensions

| Shell Size | A | B | C | D | E | F | W | L |
|------------|---------------|---------------|---------------|--------------|--------------|--------------|--------------|--------------|
| DD | ±0,38 (.015) | ±0,13 (.005) | ±0,13 (.005) | ±0,13 (.005) | ±0,38 (.015) | ±0,25 (.010) | ±0,41 (.016) | ±0,25 (.010) |
| DD | 66,93 (2.635) | 52,81 (2.079) | 61,11 (2.406) | 11,07 (.436) | 15,37 (.605) | 10,82 (.426) | 6,84 (.269) | 0,99 (.039) |

40 A High Power Straight — European PC Tails (Size DD)

Receptacle



Part Numbers with Standoff #4-40 UNC

| Shell Size | Layout | Part Number Without Screw Locks Without Boardlocks | Part Number Without Screw Locks With Boardlocks | Part Number With Screw Locks With Boardlocks |
|------------|--------|--|---|--|
| DD | 24W7 | DDMV24H7SYA197 | DDMZ24H7SYA197 | DDMN24H7SYA197 |
| DD | 36W4 | DDMV36H4SYA197 | DDMZ36H4SYA197 | DDMN36H4SYA197 |
| DD | 43W2 | DDMV43H2SYA197 | DDMZ43H2SYA197 | DDMN43H2SYA197 |
| DD | 47W1 | DDMV47H1SYA197 | DDMZ47H1SYA197 | DDMN47H1SYA197 |

For M3 threads replace MV with MT, MZ with MQ, MN with MU.
 Note: For performance class 2 substitute K126 for A197. Example: DDMV24H7SYK126

Reader's Resource

- For contact cavity arrangements, see page 223.
- For P.C. hole patterns, see page 259.
- For panel cutouts, see page 221.



Screw lock, boardlock, and high power contact removed for clarity

Dimensions

| Shell Size | A | B | C | D | E | F | W | L |
|------------|---------------|---------------|---------------|--------------|--------------|--------------|--------------|--------------|
| | ±0,38 (.015) | ±0,13 (.005) | ±0,13 (.005) | ±0,13 (.005) | ±0,38 (.015) | ±0,25 (.010) | ±0,38 (.015) | ±0,25 (.010) |
| DD | 66,93 (2.635) | 52,42 (2.064) | 61,11 (2.406) | 10,74 (.423) | 15,37 (.605) | 10,90 (.429) | 6,94 (.273) | 0,76 (.030) |

90° PC Tail — European Footprint 10,2♦ or 9,4 mm♦♦ (Sizes DE-DD)

Plug



Reader's Resource

For contact cavity arrangements, see page 222.
 For P.C. hole patterns, see pages 260-262.
 For panel cutouts, see page 221.
 For hardware views (European), see page 227.

Part Numbers

| Shell Size | Layout | Part Number Without Hardware | Part Number Metal Bracket With #4-40 Nut |
|------------|--------|------------------------------|--|
| DE | 5W1 | DEM-5W1P-1A0N-K87 | DEM-5W1P-1A7N-K87 |
| DA | 7W2 | DAM-7W2P-1A0N-K87 | DAM-7W2P-1A7N-K87 |
| DA | 11W1 | DAM-11W1P-1A0N-K87 | DAM-11W1P-1A7N-K87 |
| DA | 3W3 | DAM-3W3P-1A0N-K87 | DAM-3W3P-1A7N-K87 |
| DA | 3WK3♣ | DAM-3WK3P-1A0N-K87 | DAM-3WK3P-1A7N-K87 |
| DB | 5W5 | DBM-5W5P-1A0N-K87 | DBM-5W5P-1A7N-K87 |
| DB | 9W4 | DBM-9W4P-1A0N-K87 | DBM-9W4P-1A7N-K87 |
| DB | 13W3 | DBM-13W3P-1A0N-K87 | DBM-13W3P-1A7N-K87 |
| DB | 17W2 | DBM-17W2P-1A0N-K87 | DBM-17W2P-1A7N-K87 |
| DB | 21W1 | DBM-21W1P-1A0N-K87 | DBM-21W1P-1A7N-K87 |
| DC | 8W8 | DCM-8W8P-1A0N-K87 | DCM-8W8P-1A7N-K87 |
| DC | 13W6 | DCM-13W6P-1A0N-K87 | DCM-13W6P-1A7N-K87 |
| DC | 17W5 | DCM-17W5P-1A0N-K87 | DCM-17W5P-1A7N-K87 |
| DC | 21WA4 | DCM-21WA4P-1A0N-K87 | DCM-21WA4P-1A7N-K87 |
| DC | 25W3 | DCM-25W3P-1A0N-K87 | DCM-25W3P-1A7N-K87 |
| DC | 27W2 | DCM-27W2P-1A0N-K87 | DCM-27W2P-1A7N-K87 |
| DD | 24W7 | DDM-24W7P-1A0N-K87 | DDM-24W7P-1A7N-K87 |
| DD | 36W4 | DDM-36W4P-1A0N-K87 | DDM-36W4P-1A7N-K87 |
| DD | 43W2 | DDM-43W2P-1A0N-K87 | DDM-43W2P-1A7N-K87 |
| DD | 47W1 | DDM-47W1P-1A0N-K87 | DDM-47W1P-1A7N-K87 |

Note: Performance class 3 standard, for performance class 2 add -A191. Example: DEM-5W1P-1A0N-A191-K87
 ♣ Keyed.



Dimensions

| Shell Size | A | B | C | D | E | F | W | W | K | K | L |
|------------|---------------|---------------|---------------|--------------|--------------|--------------|----------------|--------------|----------------|--------------|--------------|
| | ±0,38 (.015) | ±0,13 (.005) | ±0,13 (.005) | ±0,13 (.005) | ±0,38 (.015) | ±0,25 (.010) | ±0,368 (.0145) | ±0,41 (.016) | ±0,317 (.0125) | ±0,25 (.010) | ±0,25 (.010) |
| DE | 30,81 (1.213) | 16,92 (.666) | 24,99 (.984) | 8,36 (.329) | 12,55 (.494) | 10,72 (.422) | 6,693 (.2635) | — | 1,206 (.0475) | — | 0,76 (.030) |
| DA | 39,14 (1.541) | 25,25 (.994) | 33,32 (1.312) | 8,36 (.329) | 12,55 (.494) | 10,72 (.422) | 6,693 (.2635) | — | 1,206 (.0475) | — | 0,76 (.030) |
| DB | 53,04 (2.088) | 38,96 (1.534) | 47,04 (1.852) | 8,36 (.329) | 12,55 (.494) | 10,82 (.426) | — | 6,84 (.269) | — | 1,52 (.060) | 0,99 (.039) |
| DC | 69,32 (2.729) | 55,42 (2.182) | 63,50 (2.500) | 8,36 (.329) | 12,55 (.494) | 10,82 (.426) | — | 6,84 (.269) | — | 1,52 (.060) | 0,99 (.039) |
| DD | 66,93 (2.635) | 52,81 (2.079) | 61,11 (2.406) | 11,07 (.436) | 15,37 (.605) | 10,82 (.426) | — | 6,84 (.269) | — | 1,52 (.060) | 0,99 (.039) |

♦ Connector footprint measured from the front shell.
 ♦♦ Connector footprint measured from the rear shell.

90° PC Tail — European Footprint 10,2♦ or 9,4 mm♦♦ (Sizes DE-DD)

Receptacle



Part Numbers

| Shell Size | Layout | Part Number Without Hardware | Part Number Metal Bracket With #4-40 Nut |
|------------|--------|------------------------------|--|
| DE | 5W1 | DEM-5W1S-1A0N-A197 | DEM-5W1S-1A7N-A197 |
| DA | 7W2 | DAM-7W2S-1A0N-A197 | DAM-7W2S-1A7N-A197 |
| DA | 11W1 | DAM-11W1S-1A0N-A197 | DAM-11W1S-1A7N-A197 |
| DA | 3W3 | DAM-3W3S-1A0N-A197 | DAM-3W3S-1A7N-A197 |
| DA | 3WK3♣ | DAM-3WK3S-1A0N-A197 | DAM-3WK3S-1A7N-A197 |
| DB | 5W5 | DBM-5W5S-1A0N-A197 | DBM-5W5S-1A7N-A197 |
| DB | 9W4 | DBM-9W4S-1A0N-A197 | DBM-9W4S-1A7N-A197 |
| DB | 13W3 | DBM-13W3S-1A0N-A197 | DBM-13W3S-1A7N-A197 |
| DB | 17W2 | DBM-17W2S-1A0N-A197 | DBM-17W2S-1A7N-A197 |
| DB | 21W1 | DBM-21W1S-1A0N-A197 | DBM-21W1S-1A7N-A197 |
| DC | 8W8 | DCM-8W8S-1A0N-A197 | DCM-8W8S-1A7N-A197 |
| DC | 13W6 | DCM-13W6S-1A0N-A197 | DCM-13W6S-1A7N-A197 |
| DC | 17W5 | DCM-17W5S-1A0N-A197 | DCM-17W5S-1A7N-A197 |
| DC | 21WA4 | DCM-21WA4S-1A0N-A197 | DCM-21WA4S-1A7N-A197 |
| DC | 25W3 | DCM-25W3S-1A0N-A197 | DCM-25W3S-1A7N-A197 |
| DC | 27W2 | DCM-27W2S-1A0N-A197 | DCM-27W2S-1A7N-A197 |
| DD | 24W7 | DDM-24W7S-1A0N-A197 | DDM-24W7S-1A7N-A197 |
| DD | 36W4 | DDM-36W4S-1A0N-A197 | DDM-36W4S-1A7N-A197 |
| DD | 43W2 | DDM-43W2S-1A0N-A197 | DDM-43W2S-1A7N-A197 |
| DD | 47W1 | DDM-47W1S-1A0N-A197 | DDM-47W1S-1A7N-A197 |

Reader's Resource

For contact cavity arrangements, see page 223.
 For P.C. hole patterns, see pages 263-265.
 For panel cutouts, see page 221.
 For hardware views (European), see page 227.

Note: Performance class 3 standard, for performance class 2 add -A191. Example: DEM-5W1S-1A0N-A191-A197
 ♣ Keyed.



Dimensions

| Shell Size | A | B | C | D | E | F | W | K | L |
|------------|---------------|---------------|---------------|--------------|--------------|--------------|--------------|----------------|--------------|
| DE | ±0,38 (.015) | ±0,13 (.005) | ±0,13 (.005) | ±0,13 (.005) | ±0,38 (.015) | ±0,25 (.010) | ±0,38 (.015) | ±0,318 (.0125) | ±0,25 (.010) |
| DA | 30,81 (1.213) | 16,33 (.643) | 24,99 (.984) | 7,90 (.311) | 12,55 (.494) | 10,90 (.429) | 6,94 (.273) | 1,206 (.0475) | 0,76 (.030) |
| DB | 39,14 (1.541) | 24,66 (.971) | 33,32 (1.312) | 7,90 (.311) | 12,55 (.494) | 10,90 (.429) | 6,94 (.273) | 1,206 (.0475) | 0,76 (.030) |
| DC | 53,04 (2.088) | 38,38 (1.511) | 47,04 (1.852) | 7,90 (.311) | 12,55 (.494) | 10,90 (.429) | 6,94 (.273) | 1,206 (.0475) | 0,76 (.030) |
| DD | 69,32 (2.729) | 54,84 (2.159) | 63,50 (2.500) | 7,90 (.311) | 12,55 (.494) | 10,90 (.429) | 6,94 (.273) | 1,206 (.0475) | 0,76 (.030) |
| DD | 66,93 (2.635) | 52,42 (2.064) | 61,11 (2.406) | 10,74 (.423) | 15,37 (.605) | 10,90 (.429) | 6,94 (.273) | 1,206 (.0475) | 0,76 (.030) |

♦ Connector footprint measured from the front shell.
 ♦♦ Connector footprint measured from the rear shell.

Straight PC Tails — European (Sizes DE-DD)

Plug



Reader's Resource

For contact cavity arrangements, see page 222.
 For P.C. hole patterns, see pages 266-268.
 For panel cutouts, see page 221.
 For hardware views (European), see page 227.

Part Numbers

| Shell Size | Layout | Part Number | Part Number |
|------------|--------|--------------------|--------------------|
| | | X 4,60 (.181) | X 6,05 (.238) |
| DE | 5W1 | DEM-5W1P-OL2-K87 | DEM-5W1P-OL4-K87 |
| DA | 7W2 | DAM-7W2P-OL2-K87 | DAM-7W2P-OL4-K87 |
| DA | 11W1 | DAM-11W1P-OL2-K87 | DAM-11W1P-OL4-K87 |
| DA | 3W3 | DAM-3W3P-OL2-K87 | DAM-3W3P-OL4-K87 |
| DA | 3WK3♣ | DAM-3WK3P-OL2-K87 | DAM-3WK3P-OL4-K87 |
| DB | 5W5 | DBM-5W5P-OL2-K87 | DBM-5W5P-OL4-K87 |
| DB | 9W4 | DBM-9W4P-OL2-K87 | DBM-9W4P-OL4-K87 |
| DB | 13W3 | DBM-13W3P-OL2-K87 | DBM-13W3P-OL4-K87 |
| DB | 17W2 | DBM-17W2P-OL2-K87 | DBM-17W2P-OL4-K87 |
| DB | 21W1 | DBM-21W1P-OL2-K87 | DBM-21W1P-OL4-K87 |
| DC | 8W8 | DCM-8W8P-OL2-K87 | DCM-8W8P-OL4-K87 |
| DC | 13W6 | DCM-13W6P-OL2-K87 | DCM-13W6P-OL4-K87 |
| DC | 17W5 | DCM-17W5P-OL2-K87 | DCM-17W5P-OL4-K87 |
| DC | 21WA4 | DCM-21WA4P-OL2-K87 | DCM-21WA4P-OL4-K87 |
| DC | 25W3 | DCM-25W3P-OL2-K87 | DCM-25W3P-OL4-K87 |
| DC | 27W2 | DCM-27W2P-OL2-K87 | DCM-27W2P-OL4-K87 |
| DD | 24W7 | DDM-24W7P-OL2-K87 | DDM-24W7P-OL4-K87 |
| DD | 36W4 | DDM-36W4P-OL2-K87 | DDM-36W4P-OL4-K87 |
| DD | 43W2 | DDM-43W2P-OL2-K87 | DDM-43W2P-OL4-K87 |
| DD | 47W1 | DDM-47W1P-OL2-K87 | DDM-47W1P-OL4-K87 |

Note: Performance class 3 standard, for performance class 2 add -A191. Example: DEM-5W1P-OL2-A191-K87
 ♣ Keyed.



Dimensions

| Shell Size | A | B | C | D | E | F | W | W | K | K | L |
|------------|---------------|---------------|---------------|--------------|--------------|--------------|----------------|--------------|----------------|--------------|--------------|
| | ±0,38 (.015) | ±0,13 (.005) | ±0,13 (.005) | ±0,13 (.005) | ±0,38 (.015) | ±0,25 (.010) | ±0,368 (.0145) | ±0,41 (.016) | ±0,317 (.0125) | ±0,25 (.010) | ±0,25 (.010) |
| DE | 30,81 (1.213) | 16,92 (.666) | 24,99 (.984) | 8,36 (.329) | 12,55 (.494) | 10,72 (.422) | 6,693 (.2635) | — | 1,206 (.0475) | — | 0,76 (.030) |
| DA | 39,14 (1.541) | 25,25 (.994) | 33,32 (1.312) | 8,36 (.329) | 12,55 (.494) | 10,72 (.422) | 6,693 (.2635) | — | 1,206 (.0475) | — | 0,76 (.030) |
| DB | 53,04 (2.088) | 38,96 (1.534) | 47,04 (1.852) | 8,36 (.329) | 12,55 (.494) | 10,82 (.426) | — | 6,84 (.269) | — | 1,52 (.060) | 0,99 (.039) |
| DC | 69,32 (2.729) | 55,42 (2.182) | 63,50 (2.500) | 8,36 (.329) | 12,55 (.494) | 10,82 (.426) | — | 6,84 (.269) | — | 1,52 (.060) | 0,99 (.039) |
| DD | 66,93 (2.635) | 52,81 (2.079) | 61,11 (2.406) | 11,07 (.436) | 15,37 (.605) | 10,82 (.426) | — | 6,84 (.269) | — | 1,52 (.060) | 0,99 (.039) |

Straight PC Tails — European (Sizes DE-DD)

Receptacle



Reader's Resource

For contact cavity arrangements, see page 223.
 For P.C. hole patterns, see pages 269-271.
 For panel cutouts, see page 221.
 For hardware views (European), see page 227.

Part Numbers

| Shell Size | Layout | Part Number | Part Number |
|------------|--------|---------------------|---------------------|
| | | X 4.60 (.181) | X 6.05 (.238) |
| DE | 5W1 | DEM-5W1S-OL2-A197 | DEM-5W1S-OL4-A197 |
| DA | 7W2 | DAM-7W2S-OL2-A197 | DAM-7W2S-OL4-A197 |
| DA | 11W1 | DAM-11W1S-OL2-A197 | DAM-11W1S-OL4-A197 |
| DA | 3W3 | DAM-3W3S-OL2-A197 | DAM-3W3S-OL4-A197 |
| DA | 3WK3♣ | DAM-3WK3S-OL2-A197 | DAM-3WK3S-OL4-A197 |
| DB | 5W5 | DBM-5W5S-OL2-A197 | DBM-5W5S-OL4-A197 |
| DB | 9W4 | DBM-9W4S-OL2-A197 | DBM-9W4S-OL4-A197 |
| DB | 13W3 | DBM-13W3S-OL2-A197 | DBM-13W3S-OL4-A197 |
| DB | 17W2 | DBM-17W2S-OL2-A197 | DBM-17W2S-OL4-A197 |
| DB | 21W1 | DBM-21W1S-OL2-A197 | DBM-21W1S-OL4-A197 |
| DC | 8W8 | DCM-8W8S-OL2-A197 | DCM-8W8S-OL4-A197 |
| DC | 13W6 | DCM-13W6S-OL2-A197 | DCM-13W6S-OL4-A197 |
| DC | 17W5 | DCM-17W5S-OL2-A197 | DCM-17W5S-OL4-A197 |
| DC | 21WA4 | DCM-21WA4S-OL2-A197 | DCM-21WA4S-OL4-A197 |
| DC | 25W3 | DCM-25W3S-OL2-A197 | DCM-25W3S-OL4-A197 |
| DC | 27W2 | DCM-27W2S-OL2-A197 | DCM-27W2S-OL4-A197 |
| DD | 24W7 | DDM-24W7S-OL2-A197 | DDM-24W7S-OL4-A197 |
| DD | 36W4 | DDM-36W4S-OL2-A197 | DDM-36W4S-OL4-A197 |
| DD | 43W2 | DDM-43W2S-OL2-A197 | DDM-43W2S-OL4-A197 |
| DD | 47W1 | DDM-47W1S-OL2-A197 | DDM-47W1S-OL4-A197 |

Note: Performance class 3 standard, for performance class 2 add -A191. Example: DEM-5W1S-OL2-A191-A197
 ♣ Keyed.



Dimensions

| Shell Size | A ±0,38 (.015) | B ±0,13 (.005) | C ±0,13 (.005) | D ±0,13 (.005) | E ±0,38 (.015) | F ±0,25 (.010) | W ±0,38 (.015) | K ±0,318 (.0125) | L ±0,25 (.010) |
|------------|-------------------|-------------------|-------------------|-------------------|-------------------|-------------------|-------------------|---------------------|-------------------|
| DE | 30,81 (1.213) | 16,33 (.643) | 24,99 (.984) | 7,90 (.311) | 12,55 (.494) | 10,90 (.429) | 6,94 (.273) | 1,206 (.0475) | 0,76 (.030) |
| DA | 39,14 (1.541) | 24,66 (.971) | 33,32 (1.312) | 7,90 (.311) | 12,55 (.494) | 10,90 (.429) | 6,94 (.273) | 1,206 (.0475) | 0,76 (.030) |
| DB | 53,04 (2.088) | 38,38 (1.511) | 47,04 (1.852) | 7,90 (.311) | 12,55 (.494) | 10,90 (.429) | 6,94 (.273) | 1,206 (.0475) | 0,76 (.030) |
| DC | 69,32 (2.729) | 54,84 (2.159) | 63,50 (2.500) | 7,90 (.311) | 12,55 (.494) | 10,90 (.429) | 6,94 (.273) | 1,206 (.0475) | 0,76 (.030) |
| DD | 66,93 (2.635) | 52,42 (2.064) | 61,11 (2.406) | 10,74 (.423) | 15,37 (.605) | 10,90 (.429) | 6,94 (.273) | 1,206 (.0475) | 0,76 (.030) |

Solder Cup (Sizes DE-DD)

Plug



Reader's Resource

For contact cavity arrangements, see page 222.
 For panel cutouts, see page 221.
 For hardware views (Standard), see page 226.

Part Numbers

| Shell Size | Layout | Through Hole | Dual Float Mount | Clinch Nut #4-40 UNC |
|------------|--------|--------------|------------------|----------------------|
| DE | 5W1 | DEM5W1PK87 | DEMY5W1PK87 | DEME5W1PK87 |
| DA | 7W2 | DAM7W2PK87 | DAMY7W2PK87 | DAME7W2PK87 |
| DA | 11W1 | DAM11W1PK87 | DAMY11W1PK87 | DAME11W1PK87 |
| DA | 3W3 | DAM3W3PK87 | DAMY3W3PK87 | DAME3W3PK87 |
| DA | 3WK3♣ | DAM3WK3PK87 | DAMY3WK3PK87 | DAME3WK3PK87 |
| DB | 5W5 | DBMP5W5PK87 | DBMY5W5PK87 | DBME5W5PK87 |
| DB | 9W4 | DBM9W4PK87 | DBMY9W4PK87 | DBME9W4PK87 |
| DB | 13W3 | DBM13W3PK87 | DBMY13W3PK87 | DBME13W3PK87 |
| DB | 17W2 | DBM17W2PK87 | DBMY17W2PK87 | DBME17W2PK87 |
| DB | 21W1 | DBM21W1PK87 | DBMY21W1PK87 | DBME21W1PK87 |
| DC | 8W8 | DCM8W8PK87 | DCMY8W8PK87 | DCME8W8PK87 |
| DC | 13W6 | DCM13W6PK87 | DCMY13W6PK87 | DCME13W6PK87 |
| DC | 17W5 | DCM17W5PK87 | DCMY17W5PK87 | DCME17W5PK87 |
| DC | 21WA4 | DCM21WA4PK87 | DCMY21WA4PK87 | DCME21WA4PK87 |
| DC | 25W3 | DCM25W3PK87 | DCMY25W3PK87 | DCME25W3PK87 |
| DC | 27W2 | DCM27W2PK87 | DCMY27W2PK87 | DCME27W2PK87 |
| DD | 24W7 | DDM24W7PK87 | DDMY24W7PK87 | DDME24W7PK87 |
| DD | 36W4 | DDM36W4PK87 | DDMY36W4PK87 | DDME36W4PK87 |
| DD | 43W2 | DDM43W2PK87 | DDMY43W2PK87 | DDME43W2PK87 |
| DD | 47W1 | DDM47W1PK87 | DDMY47W1PK87 | DDME47W1PK87 |

For contacts with 30 microinches gold substitute K127 for K87. Example: DEM5W1PK127
 For M3 clinch nuts substitute X for E. Example: DEMX5W1PK87
 ♣ Keyed.



Dimensions

| Shell Size | A | B | C | D | E | F | W | W | K | K | L |
|------------|---------------|---------------|---------------|--------------|--------------|--------------|----------------|--------------|----------------|--------------|--------------|
| | ±0,38 (.015) | ±0,13 (.005) | ±0,13 (.005) | ±0,13 (.005) | ±0,38 (.015) | ±0,25 (.010) | ±0,368 (.0145) | ±0,41 (.016) | ±0,317 (.0125) | ±0,25 (.010) | ±0,25 (.010) |
| DE | 30,81 (1.213) | 16,92 (.666) | 24,99 (.984) | 8,36 (.329) | 12,55 (.494) | 10,72 (.422) | 6,693 (.2635) | — | 1,206 (.0475) | — | 0,76 (.030) |
| DA | 39,14 (1.541) | 25,25 (.994) | 33,32 (1.312) | 8,36 (.329) | 12,55 (.494) | 10,72 (.422) | 6,693 (.2635) | — | 1,206 (.0475) | — | 0,76 (.030) |
| DB | 53,04 (2.088) | 38,96 (1.534) | 47,04 (1.852) | 8,36 (.329) | 12,55 (.494) | 10,82 (.426) | — | 6,84 (.269) | — | 1,52 (.060) | 0,99 (.039) |
| DC | 69,32 (2.729) | 55,42 (2.182) | 63,50 (2.500) | 8,36 (.329) | 12,55 (.494) | 10,82 (.426) | — | 6,84 (.269) | — | 1,52 (.060) | 0,99 (.039) |
| DD | 66,93 (2.635) | 52,81 (2.079) | 61,11 (2.406) | 11,07 (.436) | 15,37 (.605) | 10,82 (.426) | — | 6,84 (.269) | — | 1,52 (.060) | 0,99 (.039) |

Solder Cup (Sizes DE-DD)

Receptacle



Reader's Resource

For contact cavity arrangements, see page 223.
 For panel cutouts, see page 221.
 For hardware views (Standard), see page 226.

Part Numbers

| Shell Size | Layout | Through Hole | Dual Float Mount | Clinch Nut #4-40 UNC |
|------------|--------|---------------|------------------|----------------------|
| DE | 5W1 | DEM5W1SA197 | DEMY5W1SA197 | DEME5W1SA197 |
| DA | 7W2 | DAM7W2SA197 | DAMY7W2SA197 | DAME7W2SA197 |
| DA | 11W1 | DAM11W1SA197 | DAMY11W1SA197 | DAME11W1SA197 |
| DA | 3W3 | DAM3W3SA197 | DAMY3W3SA197 | DAME3W3SA197 |
| DA | 3WK3♣ | DAM3WK3SA197 | DAMY3WK3SA197 | DAME3WK3SA197 |
| DB | 5W5 | DBM5W5SA197 | DBMY5W5SA197 | DBME5W5SA197 |
| DB | 9W4 | DBM9W4SA197 | DBMY9W4SA197 | DBME9W4SA197 |
| DB | 13W3 | DBM13W3SA197 | DBMY13W3SA197 | DBME13W3SA197 |
| DB | 17W2 | DBM17W2SA197 | DBMY17W2SA197 | DBME17W2SA197 |
| DB | 21W1 | DBM21W1SA197 | DBMY21W1SA197 | DBME21W1SA197 |
| DC | 8W8 | DCM8W8SA197 | DCMY8W8SA197 | DCME8W8SA197 |
| DC | 13W6 | DCM13W6SA197 | DCMY13W6SA197 | DCME13W6SA197 |
| DC | 17W5 | DCM17W5SA197 | DCMY17W5SA197 | DCME17W5SA197 |
| DC | 21WA4 | DCM21WA4SA197 | DCMY21WA4SA197 | DCME21WA4SA197 |
| DC | 25W3 | DCM25W3SA197 | DCMY25W3SA197 | DCME25W3SA197 |
| DC | 27W2 | DCM27W2SA197 | DCMY27W2SA197 | DCME27W2SA197 |
| DD | 24W7 | DDM24W7SA197 | DDMY24W7SA197 | DDME24W7SA197 |
| DD | 36W4 | DDM36W4SA197 | DDMY36W4SA197 | DDME36W4SA197 |
| DD | 43W2 | DDM43W2SA197 | DDMY43W2SA197 | DDME43W2SA197 |
| DD | 47W1 | DDM47W1SA197 | DDMY47W1SA197 | DDME47W1SA197 |

For contacts with 30 microinches gold substitute K126 for A197. Example: DEM5W1SK126
 For M3 clinch nuts substitute X for E. Example: DEMX5W1SA197
 ♣ Keyed.



Dimensions

| Shell Size | A ±0,38 (.015) | B ±0,13 (.005) | C ±0,13 (.005) | D ±0,13 (.005) | E ±0,38 (.015) | F ±0,25 (.010) | W ±0,38 (.015) | K ±0,318 (.0125) | L ±0,25 (.010) |
|------------|-------------------|-------------------|-------------------|-------------------|-------------------|-------------------|-------------------|---------------------|-------------------|
| DE | 30,81 (1.123) | 16,33 (.643) | 24,99 (.984) | 7,90 (.311) | 12,55 (.494) | 10,90 (.429) | 6,94 (.273) | 1,206 (.0475) | 0,76 (.030) |
| DA | 39,14 (1.541) | 24,66 (.971) | 33,32 (1.312) | 7,90 (.311) | 12,55 (.494) | 10,90 (.429) | 6,94 (.273) | 1,206 (.0475) | 0,76 (.030) |
| DB | 53,04 (2.088) | 38,38 (1.511) | 47,04 (1.852) | 7,90 (.311) | 12,55 (.494) | 10,90 (.429) | 6,94 (.273) | 1,206 (.0475) | 0,76 (.030) |
| DC | 69,32 (2.729) | 54,84 (2.159) | 63,50 (2.500) | 7,90 (.311) | 12,55 (.494) | 10,90 (.429) | 6,94 (.273) | 1,206 (.0475) | 0,76 (.030) |
| DD | 66,93 (2.635) | 52,42 (2.064) | 61,11 (2.406) | 10,74 (.423) | 15,37 (.605) | 10,90 (.429) | 6,94 (.273) | 1,206 (.0475) | 0,76 (.030) |

Crimp Cable Connectors without Contacts (Sizes DA-DD)

Plug



Reader's Resource
 For contact cavity arrangements, see page 222.
 For panel cutouts, see page 221.

Part Numbers

| Shell Size | Layout | Part Number |
|------------|--------|----------------|
| DA | 7W2 | DAA7W2PK87F0 |
| DA | 11W1 | DAA11W1PK87F0 |
| DA | 3W3 | DAA3W3PK87F0 |
| DB | 5W5 | DBA5W5PK87F0 |
| DB | 9W4 | DBA9W4PK87F0 |
| DB | 13W3 | DBA13W3PK87F0 |
| DB | 17W2 | DBA17W2PK87F0 |
| DB | 21W1 | DBA21W1PK87F0 |
| DC | 8W8 | DCA8W8PK87F0 |
| DC | 21WA4 | DCA21WA4PK87F0 |
| DC | 25W3 | DCA25W3PK87F0 |
| DD | 24W7 | DDA24W7PK87F0 |
| DD | 36W4 | DDA36W4PK87F0 |

Note: For crimp (Size 20) contacts and tooling, see pages 83 & 275.



Dimensions

| Shell Size | A ±0,38 (.015) | B ±0,13 (.005) | C ±0,13 (.005) | D ±0,13 (.005) | E ±0,38 (.015) | F ±0,25 (.010) | W ±0,368 (.0145) | W ±0,41 (.016) | K ±0,317 (.0125) | K ±0,25 (.010) | L ±0,25 (.010) |
|------------|-------------------|-------------------|-------------------|-------------------|-------------------|-------------------|---------------------|-------------------|---------------------|-------------------|-------------------|
| DE | 30,81 (1.213) | 16,92 (.666) | 24,99 (.984) | 8,36 (.329) | 12,55 (.494) | 10,72 (.422) | 6,693 (.2635) | — | 1,206 (.0475) | — | 0,76 (.030) |
| DA | 39,14 (1.541) | 25,25 (.994) | 33,32 (1.312) | 8,36 (.329) | 12,55 (.494) | 10,72 (.422) | 6,693 (.2635) | — | 1,206 (.0475) | — | 0,76 (.030) |
| DB | 53,04 (2.088) | 38,96 (1.534) | 47,04 (1.852) | 8,36 (.329) | 12,55 (.494) | 10,82 (.426) | — | 6,84 (.269) | — | 1,52 (.060) | 0,99 (.039) |
| DC | 69,32 (2.729) | 55,42 (2.182) | 63,50 (2.500) | 8,36 (.329) | 12,55 (.494) | 10,82 (.426) | — | 6,84 (.269) | — | 1,52 (.060) | 0,99 (.039) |
| DD | 66,93 (2.635) | 52,81 (2.079) | 61,11 (2.406) | 11,07 (.436) | 15,37 (.605) | 10,82 (.426) | — | 6,84 (.269) | — | 1,52 (.060) | 0,99 (.039) |

Crimp Cable Connectors without Contacts (Sizes DA-DD)

Receptacle



Reader's Resource

For contact cavity arrangements, see page 223.
For panel cutouts, see page 221.

Part Numbers

| Shell Size | Layout | Part Number |
|------------|--------|-----------------|
| DA | 7W2 | DAA7W2SA197F0 |
| DA | 11W1 | DAA11W1SA197F0 |
| DA | 3W3 | DAA3W3SA197F0 |
| DB | 5W5 | DBA5W5SA197F0 |
| DB | 9W4 | DBA9W4SA197F0 |
| DB | 13W3 | DBA13W3SA197F0 |
| DB | 17W2 | DBA17W2SA197F0 |
| DB | 21W1 | DBA21W1SA197F0 |
| DC | 8W8 | DCA8W8SA197F0 |
| DC | 21WA4 | DCA21WA4SA197F0 |
| DD | 24W7 | DDA24W7SA197F0 |
| DD | 36W4 | DDA36W4SA197F0 |

Note: For crimp (Size 20) contacts and tooling, see pages 83 & 275.



Dimensions

| Shell Size | A | B | C | D | E | F | W | K | L |
|------------|---------------|---------------|---------------|--------------|--------------|--------------|--------------|----------------|--------------|
| | ±0,38 (.015) | ±0,13 (.005) | ±0,13 (.005) | ±0,13 (.005) | ±0,38 (.015) | ±0,25 (.010) | ±0,38 (.015) | ±0,317 (.0125) | ±0,25 (.010) |
| DE | 30,81 (1.213) | 16,33 (.643) | 24,99 (.984) | 7,90 (.311) | 12,55 (.494) | 10,90 (.429) | 6,94 (.273) | 1,206 (.0475) | 0,76 (.030) |
| DA | 39,14 (1.541) | 24,66 (.971) | 33,32 (1.312) | 7,90 (.311) | 12,55 (.494) | 10,90 (.429) | 6,94 (.273) | 1,206 (.0475) | 0,76 (.030) |
| DB | 53,04 (2.088) | 38,38 (1.511) | 47,04 (1.852) | 7,90 (.311) | 12,55 (.494) | 10,90 (.429) | 6,94 (.273) | 1,206 (.0475) | 0,76 (.030) |
| DC | 69,32 (2.729) | 54,84 (2.159) | 63,50 (2.500) | 7,90 (.311) | 12,55 (.494) | 10,90 (.429) | 6,94 (.273) | 1,206 (.0475) | 0,76 (.030) |
| DD | 66,93 (2.635) | 52,42 (2.064) | 61,11 (2.406) | 10,74 (.423) | 15,37 (.605) | 10,90 (.429) | 6,94 (.273) | 1,206 (.0475) | 0,76 (.030) |

Shield Cans



| Ø Cable | Ferrule Ø A | Ferrule Part Number | Crimp Tool Part Number | Crimp Tool Position |
|------------|--------------|---------------------|------------------------|---------------------|
| 4,8 - 5,5 | 6,25 (.246) | 304-8810-000 | D115433-1 | B |
| 5,5 - 6,2 | 6,25 (.246) | 304-8810-000 | D115433-1 | A |
| 6,2 - 7,2 | 8,20 (.323) | 304-8811-000 | D115433-2 | B |
| 7,2 - 8,2 | 8,20 (.323) | 304-8811-000 | D115433-2 | A |
| 8,2 - 9,5 | 11,50 (.452) | 304-8812-000 | D115433-3 | B |
| 9,5 - 11,1 | 11,50 (.452) | 304-8813-000 | D115433-3 | A |

Part Numbers

Top Can (B size): 348-8946-000
 Bottom Can (B size): 348-8945-000

Note: For other available can sizes, consult factory for details.

Materials and Finishes

Shield Can and Ferrule
 Material: Steel
 Finish: Tin

Order 1 top can, 1 bottom can, 1 ferrule per connector.



Ferrule



Wire Trim Dimensions



Crimp Tool Positions



Crimp (Size 20) Contacts

Loose Contacts

Stamped contacts with insulation support are supplied loose for use with hand crimp tooling. Two sizes are available to accommodate wire ranges 20 - 26 AWG.

Pin Contact



Socket Contact



| Finish |
|-----------------------------|
| 30µ inches Gold over Nickel |

| Part Number Pin Contact | |
|----------------------------|--------------|
| 24-26 AWG | 20-24 AWG |
| 030-2487-017 | 030-2487-016 |

| Part Number Socket Contact | |
|-------------------------------|--------------|
| 24-26 AWG | 20-24 AWG |
| 030-2488-017 | 030-2488-016 |

For tooling, see this page.

Reeled Contacts (5,000 Pieces per Reel)

Stamped contacts with insulation support are supplied on reels of 5,000 for use with semi-automatic strip and crimp machines. Two sizes are available to accommodate wire ranges 20 - 26 AWG.

Pin Contacts



Socket Contacts



| Finish |
|-----------------------------|
| Gold over Nickel |
| 30µ inches Gold over Nickel |

| Part Number Pin Contact | |
|----------------------------|--------------|
| 24-26 AWG | 20-24 AWG |
| 980-2000-925 | 980-2000-924 |
| 980-2000-946 | 980-2000-945 |

| Part Number Socket Contact | |
|-------------------------------|--------------|
| 24-26 AWG | 20-24 AWG |
| 980-2000-926 | 980-2000-923 |
| 980-2000-944 | 980-2000-943 |

For semi-automatic tooling, see page 275.

Pin Contacts

Socket Contacts



Tooling

CCT-D*A-1



Hand Crimp Tool

| Description | Part Number |
|-------------|--------------|
| CCT-D*A-1 | 995-2000-000 |

Extraction Tool

| Description | Part Number | Wire Size |
|----------------|--------------|-----------|
| CIET-D*A-20-24 | 980-0008-135 | 20-24 AWG |
| CIET-D*A-24-26 | 980-0008-136 | 24-26 AWG |

For semi-automatic tooling, see page 275.

Cable (Size 8) Loose Contacts — Coaxial 75 Ohm

Stamped Crimp/Crimp

Recommended Wire Trim Dimensions



Kit (Body, Ferrule, Center Contact)

| Stamped Crimp/Crimp | Kit Gold over Ni | Kit 30µ in. Gold over Ni | Kit 50µ in. Gold over Ni | RG Cable Number |
|---------------------|---------------------|-----------------------------|-----------------------------|-----------------|
| Plug | D130322-2 | D130322-1 | D130322-6 | 179/U |
| Receptacle | D130344-1 | D130344 | D130344-2 | 179/U |

Loose Components for High Volume (3 Pieces — Body, Ferrule, Center Contact)

| Stamped Crimp/Crimp | Body | Ferrule | Center Contact Gold over Ni 10,000 Reel | Center Contact 30µ in. Gold over Ni 10,000 Reel |
|---------------------|--------------|--------------|---|---|
| Plug | 249-2272-000 | 304-0444-000 | 110238-1015 | 110238-1012 |
| Receptacle | 249-2271-000 | 304-0444-000 | 110238-1014 | 110238-1013 |

Tooling for Stamped Crimp/Crimp



| Description | Crimping Tool | Tool Number |
|--------------------------|------------------------|------------------|
| Stamped Center Conductor | Hand Crimp, "B" Crimp | CCTP-750HM |
| | Semi-Automatic Crimper | ABT-607 (Leased) |
| Stamped Outer Conductor | Hand Tool, Hex Crimp | CCTP-DM |
| | Pneumatic Hex Crimp | 995-2000-094 |

For semi-automatic tooling, see page 275.

Cable (Size 8) Loose Contacts — Coaxial 75 Ohm — 90°

90° Crimp Braid/Solder Center Contact

| | Part Number Gold over Ni | Part Number 30µ in. Gold over Ni | Part Number 50µ in. Gold over Ni |
|------------|-----------------------------|-------------------------------------|-------------------------------------|
| Plug | D130357-1 | D130357 | D130357-4 |
| Receptacle | D130356-1 | D130356 | D130356-3 |



Plug



Receptacle

Note: Ferrule not shown.

Note: Ferrule not shown.

Tooling for 90° Crimp Braid



| Description | Part Number |
|-------------|--------------|
| Hand Tool: | 995-0001-761 |
| Die Set: | 995-2000-110 |

Cable (Size 8) Loose Contacts — Coaxial 50 Ohm — Straight

Straight Crimp Braid



Plug



Receptacle

Note: Dimensions include outer sleeve.

| | Part Number Gold Over Nickel | Part Number 50µ in. Gold Over Copper | A max. | B max. | D min. | RG Cable Number | |
|------------|---------------------------------|--|--------------|---------------|-------------|-----------------|------------------|
| | | | | | | Old | New |
| Plug | DM53740 | DM53740-17 | 18,80 (.739) | 24,00 (.945) | 1,00 (.040) | 196/U | 178B/U |
| Plug | DM53740-1 | DM53740-15 | 18,80 (.739) | 24,00 (.945) | 1,70 (.067) | 187/U 188/U | 179B/U 316B/U |
| Plug | DM53740-35 | — | 18,80 (.739) | 24,00 (.945) | 1,70 (.067) | — | RD316 |
| Plug | DM53740-3 | DM53740-16 | 21,50 (.847) | 26,34 (1.037) | 2,79 (.110) | 195/U | 180B/U |
| Plug | DM53740-5 | DM53740-18 | 21,50 (.847) | 26,34 (1.037) | 3,18 (.125) | 58/U | 58B/U |
| Receptacle | DM53742 | DM53742-18 | 18,80 (.739) | 24,00 (.945) | 1,00 (.040) | 196/U | 178B/U |
| Receptacle | DM53742-1 | DM53742-16 | 18,80 (.739) | 24,00 (.945) | 1,70 (.067) | 187/U 188/U | 179B/U 316B/U |
| Receptacle | DM53742-36 | — | 18,80 (.739) | 24,00 (.945) | 1,70 (.067) | — | RD316 |
| Receptacle | DM53742-3 | DM53742-17 | 21,50 (.847) | 26,34 (1.037) | 2,79 (.110) | 195/U | 180B/U |
| Receptacle | DM53742-5 | DM53742-19 | 21,50 (.847) | 26,34 (1.037) | 3,18 (.125) | 58/U | 58B/U |

For crimp tooling, see page 89.

Straight Solder Braid



Plug



Receptacle

| | Part Number Gold Over Nickel | Part Number 50µ in. Gold Over Copper | A max. | B max. | D min. | RG Cable Number | |
|-------------------------|---------------------------------|--|--------------|---------------|-------------|-----------------|------------------|
| | | | | | | Old | New |
| Plug | DM53740-5008 | DM53740-5105 | 18,80 (.739) | 24,00 (.945) | 1,00 (.040) | 196/U | 178B/U |
| Plug | DM53740-5001 | DM53740-5099 | 18,80 (.739) | 24,00 (.945) | 1,70 (.067) | 187/U 188/U | 179B/U 316B/U |
| Plug | DM53740-5145 | — | 18,80 (.739) | 24,00 (.945) | 1,70 (.067) | — | RD316 |
| Plug | DM53740-5002 | DM53740-5104 | 21,50 (.847) | 26,34 (1.037) | 2,79 (.110) | 195/U | 180B/U |
| Plug | DM53740-5005 | DM53740-5101 | 21,50 (.847) | 26,34 (1.037) | 3,18 (.125) | 58/U | 58/U |
| Plug (Short Type) | DM53740-5000 | DM53740-5100 | 17,00 (.670) | 22,20 (.874) | 1,14 (.045) | 196/U | 178B/U |
| Receptacle | DM53742-5006 | DM53742-5092 | 18,80 (.739) | 24,00 (.945) | 1,00 (.040) | 196/U | 178B/U |
| Receptacle | DM53742-5001 | DM53742-5089 | 18,80 (.739) | 24,00 (.945) | 1,70 (.067) | 187/U 188/U | 179B/U 316B/U |
| Receptacle | DM53742-5126 | — | 18,80 (.739) | 24,00 (.945) | 1,70 (.067) | — | RD316 |
| Receptacle | DM53742-5002 | DM53742-5091 | 21,50 (.847) | 26,34 (1.037) | 2,79 (.110) | 195/U | 180B/U |
| Receptacle | DM53742-5004 | DM53742-5086 | 21,50 (.847) | 26,34 (1.037) | 3,18 (.125) | 58/U | 58/U |
| Receptacle (Short Type) | DM53742-5000 | DM53742-5085 | 17,00 (.670) | 22,20 (.874) | 1,14 (.045) | 196/U | 178B/U |

Cable (Size 8) Loose Contacts — Coaxial 50 Ohm — 90°

90° Crimp Braid



Plug



Receptacle

Note: Dimensions include outer sleeve.

| | Part Number Gold Over Nickel | Part Number 50µ in. Gold Over Copper | A max. | B max. | C | D ±0,13 (.005) | RG Cable Number | |
|------------|---------------------------------|---|--------------|--------------|--------------|-------------------|-----------------|------------------|
| | | | | | | | Old | New |
| Plug | DM53741 | DM53741-12 | 13,46 (.530) | 18,92 (.745) | 15,10 (.594) | 1,14 (.045) | 196/U | 178B/U |
| Plug | DM53741-1 | DM53741-11 | 13,46 (.530) | 18,92 (.745) | 15,10 (.594) | 1,83 (.072) | 187/U 188/U | 179B/U 316B/U |
| Plug | DM53741-3 | DM53741-10 | 13,46 (.530) | 18,92 (.745) | 16,00 (.630) | 2,79 (.110) | 195/U | 180B/U |
| Plug | DM53741-4 | DM53741-13 | 13,46 (.530) | 18,92 (.745) | 16,00 (.630) | 3,18 (.125) | 58/U | 58B/U |
| Receptacle | DM53743-2 | DM53743-18 | 13,46 (.530) | 18,92 (.745) | 15,09 (.594) | 1,14 (.045) | 196/U | 178B/U |
| Receptacle | DM53743-3 | DM53743-16 | 13,46 (.530) | 18,92 (.745) | 15,09 (.594) | 1,83 (.072) | 187/U 188/U | 179B/U 316B/U |
| Receptacle | DM53743-5 | DM53743-17 | 13,46 (.530) | 18,92 (.745) | 16,00 (.630) | 2,79 (.110) | 195/U | 180B/U |
| Receptacle | DM53743-6 | DM53743-19 | 13,46 (.530) | 18,92 (.745) | 16,00 (.630) | 3,18 (.125) | 58/U | 58B/U |

For crimp tooling, see page 89.

90° Solder Braid



Plug



Receptacle

| | Part Number Gold Over Nickel | Part Number 50µ in. Gold Over Copper | A max. | B max. | C | D min. | RG Cable Number | |
|------------|---------------------------------|---|--------------|--------------|--------------|-------------|-----------------|------------------|
| | | | | | | | Old | New |
| Plug | DM53741-5000 | DM53741-5059 | 13,46 (.530) | 18,92 (.745) | 15,10 (.594) | 1,00 (.040) | 196/U | 178B/U |
| Plug | DM53741-5001 | DM53741-5062 | 13,46 (.530) | 18,92 (.745) | 15,10 (.594) | 1,70 (.067) | 187/U 188/U | 179B/U 316B/U |
| Plug | DM53741-5003 | DM53741-5063 | 13,46 (.530) | 18,92 (.745) | 16,00 (.630) | 2,79 (.110) | 195/U | 180B/U |
| Plug | DM53741-5004 | DM53741-5060 | 13,46 (.530) | 18,92 (.745) | 16,00 (.630) | 3,18 (.125) | 58/U | 58/U |
| Receptacle | DM53743-5000 | DM53743-5073 | 13,46 (.530) | 18,92 (.745) | 15,09 (.594) | 1,00 (.040) | 196/U | 178B/U |
| Receptacle | DM53743-5001 | DM53743-5076 | 13,46 (.530) | 18,92 (.745) | 15,09 (.594) | 1,70 (.067) | 187/U 188/U | 179B/U 316B/U |
| Receptacle | DM53743-5003 | DM53743-5077 | 13,46 (.530) | 18,92 (.745) | 16,00 (.630) | 2,79 (.110) | 195/U | 180B/U |
| Receptacle | DM53743-5004 | DM53743-5074 | 13,46 (.530) | 18,92 (.745) | 16,00 (.630) | 3,18 (.125) | 58/U | 58B/U |

Insertion/Extraction Instructions for Coaxial, High Power and High Voltage Contacts

Insertion Tool

No insertion tool is required. The contact is easily snapped in from the rear of the connector manually.

Insertion Instructions



Extraction Tool

CET-C6B-2

Operating Instructions



The CET-C6B-2 tool extracts all coaxial, high power and high voltage contacts (plug and receptacle).

To extract the coaxial contact, hold the tool by the body and insert the tip into the front of the contact cavity until it bottoms and closes the coaxial retaining ring. Holding the body in this position

securely enough to keep coaxial retaining ring closed, push the plunger; contact will be pushed out of the rear of the assembly.

| Description | Part Number |
|-------------|-------------|
| CET-C6B-2 | 070064-0002 |

Coaxial Assembly Instructions

Straight and 90° Coaxial Assembly
STEP 1:

Slide the outer ring over the cable jacket. Trim the cable as specified in the table of Coaxial Cable Trim Dimensions (see this page). Insert the cable dielectric and center conductor into the inside diameter of the inner sleeve. Then solder the center conductor to the coaxial center contact.

Straight Coaxial



90° Coaxial



Straight and 90° Coaxial Assembly
STEP 2:

Slide the outer ring forward until it is flush with the coaxial shell containing the braid between the outer ring and the inner sleeve. For solder type coaxes, soft solder the outer ring to the assembly through the cross-drilled solder hold. For crimp type coaxes, crimp with the appropriate tool in the area defined.

Straight Coaxial



90° Coaxial



Coaxial Cable Trim Dimensions



| RG Cable Number | Straight Coaxial | | | 90° Coaxial | | |
|--|--------------------|--------------------|--------------------|--------------------|--------------------|--------------------|
| | N ± 0,25 (.010) | O ± 0,25 (.010) | P ± 0,25 (.010) | N ± 0,25 (.010) | O ± 0,25 (.010) | P ± 0,25 (.010) |
| 196/U, 178B/U, 187/U, 188/U, 179B/U, 316B/U | 7,92 (.312) | 6,35 (.250) | 1,98 (.078) | 9,52 (.375) | 5,94 (.234) | 1,57 (.062) |
| 195/U, 180B/U, 58/U, 58B/U | 9,52 (.375) | 7,92 (.312) | 1,98 (.078) | 10,69 (.422) | 7,92 (.312) | 2,39 (.094) |

Crimp Tooling



| RG Cable Number | Tool Part Number | Description | Closure |
|---------------------------------|------------------|-------------|---------|
| 196/U, 178B/U | 070051-0000 | CCT-DM | C |
| 187/U, 179B/U, 188/U, 316B/U | 070051-0000 | CCT-DM | B |
| 195/U, 180B/U, 58/U, 58B/U | 070051-0000 | CCT-DM | A |

Hand tool with integral die set for all coaxial straight crimp braid.

Cable (Size 8) Loose Contacts — High Power — Solder

Plug



| Part Number Gold Over Nickel | Part Number 50µ in. Gold over Ni | Current Rating | Wire Size |
|---------------------------------|-------------------------------------|----------------|-----------|
| DM53745-1 | DM53745-28 | 40 A | 8 AWG |
| DM53745-7 | DM53745-27 | 20 A | 12 AWG |
| DM53745-8 | DM53745-25 | 10 A | 16 AWG |

Receptacle



| Part Number Gold Over Nickel | Part Number 50µ in. Gold over Ni | Current Rating | Wire Size |
|---------------------------------|-------------------------------------|----------------|-----------|
| DM53744-1 | DM53744-21 | 40 A | 8 AWG |
| DM53744-6 | DM53744-25 | 20 A | 12 AWG |
| DM53744-7 | DM53744-24 | 10 A | 16 AWG |

Cable (Size 8) Loose Contacts — High Power — Crimp

Plug



Recommended Wire Trim Length



| Part Number Gold Over Nickel | Part Number 30µ in. Gold over Ni | Part Number 50µ in. Gold over Ni | ØA max. | ØB max. | Current Rating | Wire Size |
|---------------------------------|-------------------------------------|-------------------------------------|-------------|-------------|----------------|-----------|
| DM130338-4 | DM130338 | DM130338-1 | 4,60 (.181) | 5,84 (.230) | 40 A | 8 AWG |
| DM130339-4 | DM130339 | DM130339-1 | 2,54 (.100) | 5,54 (.218) | 20 A | 12 AWG |
| DM130340-4 | DM130340 | DM130340-1 | 1,07 (.067) | 2,59 (.102) | 10 A | 16 AWG |

Receptacle



Recommended Wire Trim Length



| Part Number Gold Over Nickel | Part Number 30µ in. Gold over Ni | Part Number 50µ in. Gold over Ni | ØA max. | ØB max. | Current Rating | Wire Size |
|---------------------------------|-------------------------------------|-------------------------------------|-------------|-------------|----------------|-----------|
| DM130341-4 | DM130341 | DM130341-1 | 4,60 (.181) | 5,84 (.230) | 40 A | 8 AWG |
| DM130342-4 | DM130342 | DM130342-1 | 2,54 (.100) | 5,54 (.218) | 20 A | 12 AWG |
| DM130343-4 | DM130343 | DM130343-1 | 1,07 (.067) | 2,59 (.102) | 10 A | 16 AWG |

High Power Crimp Tooling

M300-BT



| Wire Size | Crimp Tool/Locator | | |
|-----------|--------------------|---------------------|---------|
| | Crimp Tool | Tool Setting Number | Locator |
| 8 AWG | M300-BT | 6 | TP968 |
| 10 AWG | M300-BT | 5 | TP968 |
| 12/14 AWG | M300-BT | 1 | TP968 |
| 16 AWG | FT-8 | 6 | TH554 |
| 18 AWG | FT-8 | 5 | TH554 |

Cable (Size 8) Loose Contacts — High Voltage — Straight

Plug



For tooling, see page 88.

| Part Number Gold over Ni | Part Number 50 μ . in. Gold | Wire Size |
|-----------------------------|------------------------------------|--------------|
| DM51157 | DM51157-8 | 20 AWG |

Receptacle



For tooling, see page 88.

| Part Number Gold over Ni | Part Number 50 μ . in. Gold | Wire Size |
|-----------------------------|------------------------------------|--------------|
| DM51155 | DM51155-7 | 20 AWG |

Cable (Size 8) Loose Contacts — High Voltage — 90°

Plug



For tooling, see page 88.

| Part Number Gold over Ni | Part Number 50 μ . in. Gold | Wire Size |
|-----------------------------|------------------------------------|--------------|
| DM51157-5000 | DM51157-5005 | 20 AWG |

Receptacle



For tooling, see page 88.

| Part Number Gold over Ni | Part Number 50 μ . in. Gold | Wire Size |
|-----------------------------|------------------------------------|--------------|
| DM51155-5000 | DM51155-5004 | 20 AWG |

PCB (Size 8) Loose Contacts — Coaxial 75 Ohm — Straight

Plug



| Description | Part Number |
|-------------|-------------|
| Plug | DM130358-2 |

Receptacle



| Description | Part Number |
|-------------|-------------|
| Receptacle | DM130346-2 |

PCB (Size 8) Loose Contacts — Coaxial 75 Ohm — 90°

Plug



| Description | Part Number |
|-------------|-------------|
| Plug | DM130352-2 |

Receptacle



| Description | Part Number |
|-------------|-------------|
| Receptacle | DM130321-3 |

PCB (Size 8) Loose Contacts — High Power — Straight

Pin



| Description | Part Number |
|-------------|-------------|
| Pin | DM53745-110 |



Socket



| Description | Part Number |
|-------------|-------------|
| Socket | DM53744-98 |



PCB (Size 8) Loose Contacts — High Power — 90°

Pin



| Shell Size | Part Number | A ± 0,25 (.010) | B ± 0,25 (.010) | Ø C ± 0,13 (.005) |
|---------------------------------------|-------------|--------------------|--------------------|----------------------|
| DE, DA, DB, DC | DM53745-104 | 10,62 (.418) | 26,64 (1.049) | 3,18 (.125) |
| DD | DM53745-107 | 13,41 (.528) | 26,64 (1.049) | 3,18 (.125) |
| European Footprint DE, DA, DB, DC, DD | DM53745-120 | 18,06 (.711) | 11,00 (.433) | 2,90 (.114) |

Socket



| Shell Size | Part Number | A ± 0,25 (.010) | B ± 0,25 (.010) | Ø C ± 0,13 (.005) |
|---------------------------------------|-------------|--------------------|--------------------|----------------------|
| DE, DA, DB, DC | DM53744-92 | 13,41 (.528) | 26,52 (1.044) | 3,18 (.125) |
| DD | DM53744-95 | 10,62 (.418) | 26,52 (1.044) | 3,18 (.125) |
| European Footprint DE, DA, DB, DC, DD | DM53744-107 | 11,00 (.433) | 17,93 (.706) | 2,90 (.114) |

PCB (Size 8) Loose Contacts — High Voltage — Straight

Plug



| | |
|-----------------------------|-----------------------------|
| Part Number Gold over Ni | Part Number 50µ in. Gold |
| DM51157-13 | DM51157-14 |

Receptacle



| | |
|-----------------------------|-----------------------------|
| Part Number Gold over Ni | Part Number 50µ in. Gold |
| DM51155-12 | DM51155-13 |

PCB Guide Pin and Socket



Installs into any Combo D, Size 8 cavity. This guide pin and socket system is ideal for blind mate applications where space is limited.

PCB Guide Pin



| Part Number | Material | Finish |
|-------------|--------------|--------|
| DM53745-126 | Copper Alloy | Tin |



PCB Guide Socket



| Part Number | Material | Finish |
|--------------|--------------|--------|
| 248-2967-000 | Copper Alloy | Tin |



| | Page |
|---|------|
| Selection Index | |
| Commercial Shielded Micro D | |
| An Introduction | 97 |
| Locking/Latching Options | 98 |
| Cable Assemblies — Pigtail | 98 |
| PCB Connector 90° — Single or Stacked | 99 |
| Cable Connectors (Unassembled Components) | 100 |
| Crimp Contacts | 100 |
| Tooling | 101 |
| MDSM SSA Compatible Cable Assemblies | 102 |

MDSM is the commercial industry's smallest D-type connector for shielded I/O wire-to-board applications. Requiring less than 1/3 the area of a traditional D Subminiature connector, MDSM is designed for situations where space and EMI shielding are the primary design drivers.

Unlike other micro connectors, MDSM's rugged construction and unique contact design combined with a PdNi contact finish provide durability of 10,000 mating cycles. All of this comes in a sleek package that includes a snap together shield can and a slide over boot producing a cable assembly with an overmolded look and a low assembled cost. MDSM is an ideal solution for applications where size, shielding, durability and aesthetics are key design criteria.

Applications:

- Electronic Notepads
- VME Cards
- Multiplexors
- Serial Storage Devices
- Computer Workstations
- Hand Held Devices
- Bar Code Scanners



Product Features

1,27 (.050) Pitch / Saves Space
 Fully Shielded / Reduces EMI
 Crimp Contacts / Applied Cost Savings
 Accessories Included / Fewer Part Numbers
 PdNi Plating / 10,000 Mating Cycles

Stacked Versions / Saves Horizontal Space
 Slide Over Boot / Results in Overmolded Appearance
 Choice of Two Different Latching Options (Thumbscrew / Push-Pull)

Approvals & Certifications
 SSA (Serial Storage Architecture)
 U.L. File Number E8572
 ISO 9001

Specifications

| | |
|---------------------------------|----------------------|
| Temperature Rating | - 55°C to 125°C |
| Current Rating | 1 A — temp dependent |
| Contact Resistance | 20 mΩ Max. |
| Insulation Resistance | 5000 MΩ Min. |
| Dielectric Withstanding Voltage | 350 V at Sea Level |
| Durability | 10,000 Mating Cycles |
| Shock / Vibration | 50 G's / 50 G's |
| Wire Size | 26 to 30 AWG |

Materials and Finishes

| Description | Material | Finish |
|-------------|-------------------------|--|
| Shell | Steel | Nickel |
| Shield Can | Steel | Tin |
| Cover | Steel | Tin |
| Insulator | Thermoplastic, UL94 V-O | None |
| Contacts | Copper Alloy | Gold flash over 30 microinches PdNi in mating area, Tin on balance |

Contact Arrangements

(Face View of Pin Insert — Use Mirror Image for Socket Side)



Locking/Latching Options

Jackscrew



The jackscrew locking system is designed for applications which require a secure connection. Utilize thumbscrews when the connectors are infrequently unmated.

Push/Pull



The push/pull latching system is designed for applications which require a quick connect and disconnect. A spring retention mechanism latches to a post on the board side to prevent unintentional unmatings.

Z10 Jackpost



Note: Two Jackposts supplied with boardside connectors.

Z42 Jackpost

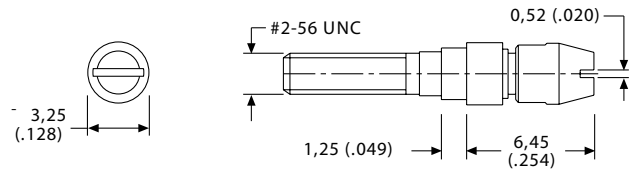

Note: Two Jackposts supplied with boardside connectors.

PCB Connector 90° - Single



Note: Standard jackpost offering recommended for use with .060 panel.

| No. of Contacts | Part Numbers - Single | | A max. | B | C max. | D max. | E | F ±0.05 (.002) |
|-----------------|-----------------------|--------------------|---------------|--------------|--------------|--------------|--------------|----------------|
| | Thumbscrew | Push/Pull | | | | | | |
| 9 | MDSM-9PE-Z10-VR25* | MDSM-9E-Z42-VR25* | 19,90 (.783) | 14,35 (.565) | 8,60 (.339) | 9,00 (.354) | 5,08 (.200) | 10,24 (.403) |
| 15 | MDSM-15PE-Z10-VR22 | MDSM-15PE-Z42-VR22 | 23,60 (.929) | 18,16 (.715) | 12,30 (.484) | 12,90 (.508) | 8,89 (.350) | 14,01 (.551) |
| 25 | MDSM-25PE-Z10-VR17 | MDSM-25PE-Z42-VR17 | 29,95 (1.179) | 24,51 (.965) | 18,65 (.734) | 19,25 (.758) | 15,24 (.600) | 20,35 (.801) |

*For use with SSA applications

PCB Connector 90° - Stacked



| No. of Contacts | Part Numbers - Stacked | | A max. | B | C max. | D max. | E | F |
|-----------------|------------------------|---------------------|--------------|--------------|--------------|--------------|-------------|--------------|
| | Thumbscrew | Push/Pull | | | | | | |
| 18 | MDSM-18PE-Z10-VR25* | MDSM-18PE-Z42-VR25* | 19,90 (.783) | 14,35 (.565) | 8,60 (.339) | 9,00 (.354) | 5,08 (.200) | 10,24 (.403) |
| 30 | MDSM-30PE-Z10-VR22 | MDSM-30PE-Z42-VR22 | 23,50 (.925) | 18,16 (.715) | 12,30 (.484) | 12,71 (.500) | 8,89 (.350) | 14,00 (.551) |

*For use with SSA applications

Cable Connectors (Unassembled Components)

Jackscrew



Cable connectors are supplied as complete kits with insulator, hood, locking hardware, shell/shield assembly, and cover, bulk packaged.



Push/Pull



Cable connectors are supplied as complete kits with insulator, hood, shell/shield assembly, and cover, bulk packaged.



| Layout | Jackscrew Part Numbers | Push/Pull Part Numbers | A max. | B 0,10 (.004) | C 0,10 (.004) | D max. | Max. Cable Entry |
|--------|------------------------|------------------------|---------------|---------------|---------------|--------------|------------------|
| 9 | MDSM-9SC-Z11-VS1 | MDSM-9SC-Z24-VS1 | 19,90 (.783) | 14,35 (.565) | 9,45 (.372) | 35,50 (1.40) | 5,70 (.224) |
| 15 | MDSM-15SC-Z11-VS1 | MDSM-15SC-Z24-VS1 | 23,70 (.993) | 18,16 (.715) | 13,17 (.519) | 35,50 (1.40) | 6,70 (.264) |
| 25 | MDSM-25SC-Z11-VS1 | MDSM-25SC-Z24-VS1 | 30,05 (1.183) | 24,51 (.965) | 19,52 (.769) | 42,50 (1.67) | 7,90 (.311) |

Note: VS1 refers to packaging multiples of 100. Contacts are sold separately, see this page.

Crimp Contacts

Wire Trim Dimensions



| Socket | Part Numbers | |
|--------|------------------|-------------------|
| | 1,000 Piece Reel | 10,000 Piece Reel |
| | MDS-S-TS | MDS-S-RL |

For crimp tooling, see page 101.

Contact Crimping Tools

Parallel Action Low Volume Hand Tool



Part Number: CCTP-MDS

Note: For use with individual contacts (break off reel MDS-S-TS or MDS-S-RL.

Hand Tool



Part Number: CCTR-MDS

Note: For use with reeled contacts - Part Number MDS-S-TS.

Semi-Automatic Crimper/Stripper



Part Number: ABT-620-MDS (Lease Only)

Note: For use with reeled contacts - Part Number MDS-S-RL. For additional information, see page 275. Crimp dies for SSA Cable will be offered by ITT Cannon. Consult factory for details.

Contact Insertion/Extraction Tools

Jackpost Tool



Part Number: CIET-MDSM

Note: For use with Z10 Jackpost.

Insertion Tool



Part Number: 120090-0102

Note: Contacts cannot be removed from MDSM connectors.

Shield Crimp Tooling

Shield crimping requires four items; one press, one locator, and one each of the two dies listed below.

Locator and Dies for Shield Termination Ordered Separately

| Layout | Part Numbers | |
|--------|--------------|---------------------------|
| | Locator | Die |
| 9 | 317-8666-013 | 274-8649-332/274-8649-333 |
| 15 | 317-8666-014 | 274-8649-334/274-8649-335 |
| 25 | 317-8666-016 | 274-8649-338/274-8649-339 |

Note: For assembly instructions and crimping information, refer to Manual #MY-1/190.

Hand Press



Part Number: CHP-MDSM-SR

Pneumatic Press



Part Number: CPT-MDSM-SR

MDSM SSA Compatible Cable Assemblies



ITT Cannon's 9 position MDSM connectors have been designed into the ANSI specification called SSA, "Serial Storage Architecture," as the external I/O. SSA is a new serial interface for interconnecting storage devices, storage subsystems, servers and workstations. Storage subsystems are increasing in function, availability, density and performance. With this comes the trend for them to become more complex and ITT Cannon has the interconnect system which meets SSA's high performance requirements.

SSA is an architecture which allows these new subsystems to be implemented more easily and at lower costs than other new high speed parallel

interfaces. SSA permits the transfer of data at progressively higher speeds - 20 MB/sec interface currently available with 40 MB/sec becoming available in 1997/98. ITT Cannon's MDSM connector not only functions at these high speeds, but also brings to SSA smaller, less cumbersome and higher reliability cables and connectors than current options.

ITT Cannon is offering SSA compatible external cable assemblies in six different lengths to meet your needs. These assemblies consist of two MDSM 9SC type cable connectors terminated to SSA specified external cable.



Note: Cables shown with Z50 thumbscrews.

| Part Number | X Meter (Feet) | Tolerance |
|-------------|-------------------|----------------|
| CA112104 | 0,50 (1.600) | ±25,00 (1.000) |
| CA112104-1 | 1,00 (2.200) | ±25,00 (1.000) |
| CA112104-2 | 3,00 (9.800) | ±25,00 (1.000) |
| CA112104-3 | 5,00 (16.400) | ±64,00 (2.500) |
| CA112104-4 | 10,00 (32.800) | ±64,00 (2.500) |
| CA112104-5 | 20,00 (65.600) | ±64,00 (2.500) |

Note: For push/pull assemblies or other thumbscrews, please consult the factory. Crimp dies for SSA applications will be offered by ITT Cannon. Consult factory for details.

Pinout

SSA External Cable Wiring Table



Note: Shield connected to both shells.

External Cable Pinouts

| P1 | | P2 | |
|-----|-------------|-----|-------------|
| Pin | Signal Name | Pin | Signal Name |
| 2 | LineOut- | 4 | LineIn- |
| 6 | LineOut+ | 9 | LineIn+ |
| 4 | LineIn- | 2 | LineOut- |
| 9 | LineIn+ | 6 | LineOut+ |

Note: Pins 1, 3, 5, 7 and 8 are not connected.

SSA External Cable Wire Cross Section (For Reference Only)



Transfer Impedance Performance Requirements for External SSA Connections

| Frequency MHz | Value (dB-Ohm)(max.) |
|---------------|----------------------|
| 30 | -25 |
| 159 | -16 |
| 500 | -10 |

| Selection Index | Page |
|---|------|
| Filter D | |
| An Introduction to D*JK and D*JT | 105 |
| D*JK Filter Performance and Electrical Data | 106 |
| D*JT Filter Performance and Electrical Data | 107 |
| D*JK Connectors | |
| Standard Footprint .318◆ or .283◆◆ inches | |
| 90° PC Tails | 108 |
| 90° PC Tails, Metal Brackets | 112 |
| European Footprint 10,2◆ or 9,4◆◆ mm | |
| 90° PC Tails | 110 |
| 90° PC Tails, Metal Brackets | 114 |
| 90° PC Tails, Plastic Brackets & Grounding Straps | 116 |
| 90° PC Tails, Plastic Brackets | 118 |
| Straight PC Tails | 120 |
| D*JT Connectors | |
| Solder Cup | 122 |
| Combo — High Power 90° | 124 |
| Combo — High Power Straight | 126 |
| Combo — High Power Solder Cup | 128 |

◆ Connector footprint measured from the front shell.
 ◆◆ Connector footprint measured from the rear shell.

D*JK/D*JT

Filter connectors series D*JK and D*JT from ITT Cannon especially designed for commercial applications provide excellent protection against EMI and RFI.

Using D Subminiature standard components a cost-effective production can be achieved as well as 100% compatibility with equivalent products according to DIN 41652. D Subminiature standard accessories can be used.

High quality tubular ceramic capacitors are assembled onto the D*JK contacts and soldered to contact and backshell while series D*JT connectors apply planar array filters.

Applications:

- EMI/RFI Sensitive Electronics
- Test & Measurement Equipment
- Computer Equipment
- Medical Equipment
- Telecommunication Transmission



Product Features

HF-tightness and mechanical stability by closed backshell
 Free-stamped grounding fingers (pin connector only)

Straight and 90° solder pins (D*JK)
 Solder cups, straight and 90° solder pins (D*JT)

Versatile mounting possibilities (brackets, captive nuts)
 Contact finish according to performance class 2 (standard) or class 1

Specifications

Temperature Range Per DIN IEC 68 Part 1 -55°C to 125°C

Materials and Finishes

| Description | Material | Finish |
|-------------|-------------------------|------------------|
| Shell | Steel | Tin |
| Insulator | Thermoplastic, UL 94V-0 | None |
| Contacts | Copper Alloy | Gold over Nickel |

Mechanical Data

| | |
|--------------|---|
| Coupling | Friction, accessories |
| Polarization | Keystone shape of shell |
| Termination | PC tails, straight and 90° Solder cups |

D*JK Filter Performance



D*JK Electrical Data

| | |
|--|--------------------|
| Voltage rating (working) | 100 VDC |
| Current rating | 5 A |
| Insulation resistance, electrification time 30 s, temperature 25°C | 5000 MΩ min./100 V |
| Dielectric Withstanding Voltage (Sea Level) 500 micro amps max. charge/discharge | 250 VDC |
| Filter Type C | Capacitor |
| Filter Symbol per DIN | |

| Filter designation | 5 | 4 | 3 | 2 | 1 |
|--|---------------------|---------------------|---------------------|---------------------|---------------------|
| Capacitance, type at 1 KHz, 0,1 Vrms, 25°C | 1500 pF | 1000 pF | 680 pF | 470 pF | 330 pF |
| Frequency MHz | Attenuation db min. | Attenuation db min. | Attenuation db min. | Attenuation db min. | Attenuation db min. |
| 10 | 3 | — | — | — | — |
| 30 | 20 | 14 | 10 | 7 | 2 |
| 100 | 31 | 27 | 22 | 18 | 9 |
| 300 | 39 | 35 | 30 | 27 | 18 |
| 1000 | 47 | 42 | 37 | 32 | 28 |
| 2000 | 51 | 46 | 42 | 36 | 31 |

Attenuation per MIL-STD-220 at 25°C with no applied voltage or current

D*JT Filter Performance



D*JT Electrical Data

| | |
|--|--|
| Voltage rating (working) | 200 VDC/120 Vrms, 400 Hz |
| Current rating | 5 A (Size 20 contacts), 30 A (Size 8 contacts) |
| Insulation resistance, electrification time 30 s, temperature 25°C | 10,000 MΩ min./100 V |
| Dielectric Withstanding Voltage (Sea Level) 500 micro amps max. charge/discharge | 500 VDC |
| Filter type C | Capacitor |
| Filter symbol per DIN | |

| Filter designation | 9 | 5 | 4 | 6 | 1 | 2 | 3 |
|--|---------------------|---------------------|---------------------|---------------------|---------------------|---------------------|---------------------|
| Capacitance, type at 1 KHz, 0,1 Vrms, 25°C | 47000 pF | 5000 pF | 2000 pF | 1500 pF | 1000 pF | 500 pF | 250 pF |
| Frequency MHz | Attenuation db min. | Attenuation db min. | Attenuation db min. | Attenuation db min. | Attenuation db min. | Attenuation db min. | Attenuation db min. |
| 5 | 30 | 11 | 6 | 3 | — | — | — |
| 10 | 37 | 16 | 10 | 7 | 5 | 2 | 1 |
| 100 | 50 | 35 | 27 | 23 | 20 | 16 | 14 |
| 1000 | 45 | 54 | 48 | 46 | 42 | 37 | 35 |
| 2000 | — | 64 | 60 | — | 60 | 60 | 60 |
| 5000 | — | 64 | 64 | — | 64 | 64 | 64 |

Attenuation per MIL-STD-220 at 25°C with no applied voltage or current

D*JK — 90° PC Tails — Standard Footprint .318♦ or .283 inch ♦♦

Plug



Part Numbers

| Shell Size | Layout | Through Hole | Clinch Nut #4-40 UNC |
|------------|--------|---------------|----------------------|
| DE | 9 | DEJK9P*-1U0N | DEJKE9P*-1U0N |
| DA | 15 | DAJK15P*-1U0N | DAJKE15P*-1U0N |
| DB | 25 | DBJK25P*-1U0N | DBJKE25P*-1U0N |
| DC | 37 | DCJK37P*-1U0N | DCJKE37P*-1U0N |

* Insert filter designator. Example: DEJK9P4-1U0N (For 1000 pF Filter Capacitance)
 Note: For performance class 1 add -A190. Example: DEJK9P1-1U0N-A190

| Filter Designator* | Filter Capacitance |
|--------------------|--------------------|
| 1 | 330 pF |
| 2 | 470 pF |
| 3 | 680 pF |
| 4 | 1000 pF |
| 5 | 1500 pF |

For electrical data, see page 106.

Reader's Resource

For contact cavity arrangements, see page 224.
 For P.C. hole patterns, see page 272.
 For panel cutouts, see page 221.
 For hardware views (European), see page 227.



Dimensions

| Shell Size | A | B | C | D | E | F | W | W | L |
|------------|---------------|---------------|---------------|--------------|--------------|--------------|--------------|--------------|--------------|
| | ±0,38 (.015) | ±0,13 (.005) | ±0,13 (.005) | ±0,13 (.005) | ±0,38 (.015) | ±0,25 (.010) | ±0,37 (.015) | ±0,41 (.016) | ±0,25 (.010) |
| DE | 30,81 (1.213) | 16,92 (.666) | 24,99 (.984) | 8,36 (.329) | 12,55 (.494) | 10,72 (.422) | 6,69 (.264) | — | 0,76 (.030) |
| DA | 39,14 (1.541) | 25,25 (.994) | 33,32 (1.312) | 8,36 (.329) | 12,55 (.494) | 10,72 (.422) | 6,69 (.264) | — | 0,76 (.030) |
| DB | 53,04 (2.088) | 38,96 (1.534) | 47,04 (1.852) | 8,36 (.329) | 12,55 (.494) | 10,72 (.422) | — | 6,84 (.269) | 0,99 (.039) |
| DC | 69,32 (2.729) | 55,42 (2.182) | 63,50 (2.500) | 8,36 (.329) | 12,55 (.494) | 10,72 (.422) | — | 6,84 (.269) | 0,99 (.039) |

- ♦ Connector footprint measured from the front shell.
- ♦♦ Connector footprint measured from the rear shell.

D*JK — 90° PC Tails — Standard Footprint .318♦ or .283 inch ♦♦

Receptacle



Part Numbers

| Shell Size | Layout | Through Hole | Clinch Nut #4-40 UNC |
|------------|--------|---------------|----------------------|
| DE | 9 | DEJK9S*-1U0N | DEJKE9S*-1U0N |
| DA | 15 | DAJK15S*-1U0N | DAJKE15S*-1U0N |
| DB | 25 | DBJK25S*-1U0N | DBJKE25S*-1U0N |
| DC | 37 | DCJK37S*-1U0N | DCJKE37S*-1U0N |

* Insert filter designator. Example: DEJK9S4-1U0N (for 1000 pF Filter Capacitance)
 Note: For performance class 1, add -A190. Example: DEJK9S1-1U0N-A190

Reader's Resource

For contact cavity arrangements, see page 224.
 For P.C. hole patterns, see page 272.
 For panel cutouts, see page 221.
 For hardware views (European), see page 227.

| Filter Designator* | Filter Capacitance |
|--------------------|--------------------|
| 1 | 330 pF |
| 2 | 470 pF |
| 3 | 680 pF |
| 4 | 1000 pF |
| 5 | 1500 pF |

For electrical data, see page 106.



Dimensions

| Shell Size | A | B | C | D | E | F | W | L |
|------------|---------------|---------------|---------------|--------------|--------------|--------------|--------------|--------------|
| | ±0,38 (.015) | ±0,13 (.005) | ±0,13 (.005) | ±0,13 (.005) | ±0,38 (.015) | ±0,25 (.010) | ±0,38 (.015) | ±0,25 (.010) |
| DE | 30,81 (1.213) | 16,33 (.643) | 24,99 (.984) | 7,90 (.311) | 12,55 (.494) | 10,90 (.429) | 6,94 (.273) | 0,76 (.030) |
| DA | 39,14 (1.541) | 24,66 (.971) | 33,32 (1.312) | 7,90 (.311) | 12,55 (.494) | 10,90 (.429) | 6,94 (.273) | 0,76 (.030) |
| DB | 53,04 (2.088) | 38,38 (1.511) | 47,04 (1.852) | 7,90 (.311) | 12,55 (.494) | 10,90 (.429) | 6,94 (.273) | 0,76 (.030) |
| DC | 69,32 (2.729) | 54,84 (2.159) | 63,50 (2.500) | 7,90 (.311) | 12,55 (.494) | 10,90 (.429) | 6,94 (.273) | 0,76 (.030) |

- ♦ Connector footprint measured from the front shell.
- ♦♦ Connector footprint measured from the rear shell.

D*JK — 90° PC Tails — European Footprint 10,2♦ or 9,4 mm♦♦

Plug



Part Numbers

| Shell Size | Layout | Through Hole | Clinch Nut #4-40 UNC | Clinch Nut M3 |
|------------|--------|---------------|----------------------|----------------|
| DE | 9 | DEJK9P*-1A0N | DEJKE9P*-1A0N | DEJKX9P*-1A0N |
| DA | 15 | DAJK15P*-1A0N | DAJKE15P*-1A0N | DAJKX15P*-1A0N |
| DB | 25 | DBJK25P*-1A0N | DBJKE25P*-1A0N | DBJKX25P*-1A0N |
| DC | 37 | DCJK37P*-1A0N | DCJKE37P*-1A0N | DCJKX37P*-1A0N |

* Insert filter designator. Example: DEJK9P4-1A0N (For 1000 pF Filter Capacitance)
 Modifier: For performance class 1 add -A190. Example: DEJK9P1-1A0N-A190

Reader's Resource

For contact cavity arrangements, see page 224.
 For P.C. hole patterns, see page 273.
 For panel cutouts, see page 221.
 For hardware options (European), see page 227.

| Filter Designator* | Filter Capacitance |
|--------------------|--------------------|
| 1 | 330 pF |
| 2 | 470 pF |
| 3 | 680 pF |
| 4 | 1000 pF |
| 5 | 1500 pF |

For electrical data, see page 106.



Dimensions

| Shell Size | A | B | C | D | E | F | W | W | L |
|------------|---------------|---------------|---------------|--------------|--------------|--------------|--------------|--------------|--------------|
| | ±0,38 (.015) | ±0,13 (.005) | ±0,13 (.005) | ±0,13 (.005) | ±0,38 (.015) | ±0,25 (.010) | ±0,37 (.015) | ±0,41 (.016) | ±0,25 (.010) |
| DE | 30,81 (1.213) | 16,92 (.666) | 24,99 (.984) | 8,36 (.329) | 12,55 (.494) | 10,72 (.422) | 6,69 (.264) | — | 0,76 (.030) |
| DA | 39,14 (1.541) | 25,25 (.994) | 33,32 (1.312) | 8,36 (.329) | 12,55 (.494) | 10,72 (.422) | 6,69 (.264) | — | 0,76 (.030) |
| DB | 53,04 (2.088) | 38,96 (1.534) | 47,04 (1.852) | 8,36 (.329) | 12,55 (.494) | 10,72 (.422) | — | 6,84 (.269) | 0,99 (.039) |
| DC | 69,32 (2.729) | 55,42 (2.182) | 63,50 (2.500) | 8,36 (.329) | 12,55 (.494) | 10,72 (.422) | — | 6,84 (.269) | 0,99 (.039) |

- ♦ Connector footprint measured from the front shell.
- ♦♦ Connector footprint measured from the rear shell.

D*JK — 90° PC Tails — European Footprint 10,2♦ or 9,4 mm♦♦

Receptacle



Part Numbers

| Shell Size | Layout | Through Hole | Clinch Nut #4-40 UNC | Clinch Nut M3 |
|------------|--------|---------------|----------------------|----------------|
| DE | 9 | DEJK9S*-1A0N | DEJKE9S*-1A0N | DEJKX9S*-1A0N |
| DA | 15 | DAJK15S*-1A0N | DAJKE15S*-1A0N | DAJKX15S*-1A0N |
| DB | 25 | DBJK25S*-1A0N | DBJKE25S*-1A0N | DBJKX25S*-1A0N |
| DC | 37 | DCJK37S*-1A0N | DCJKE37S*-1A0N | DCJKX37S*-1A0N |

* Insert filter designator. Example: DEJK9S4-1A0N (for 1000 pF Filter Capacitance)
 Note: For performance class 1, add -A190. Example: DEJK9S1-1A0N-A190

Reader's Resource

For contact cavity arrangements, see page 224.
 For P.C. hole patterns, see page 273.
 For panel cutouts, see page 221.
 For hardware options (European), see page 227.

| Filter Designator* | Filter Capacitance |
|--------------------|--------------------|
| 1 | 330 pF |
| 2 | 470 pF |
| 3 | 680 pF |
| 4 | 1000 pF |
| 5 | 1500 pF |

For electrical data, see page 106.



Dimensions

| Shell Size | A ±0,38 (.015) | B ±0,13 (.005) | C ±0,13 (.005) | D ±0,13 (.005) | E ±0,38 (.015) | F ±0,25 (.010) | W ±0,38 (.015) | L ±0,25 (.010) |
|------------|-------------------|-------------------|-------------------|-------------------|-------------------|-------------------|-------------------|-------------------|
| DE | 30,81 (1.213) | 16,33 (.643) | 24,99 (.984) | 7,90 (.311) | 12,55 (.494) | 10,90 (.429) | 6,94 (.273) | 0,76 (.030) |
| DA | 39,14 (1.541) | 24,66 (.971) | 33,32 (1.312) | 7,90 (.311) | 12,55 (.494) | 10,90 (.429) | 6,94 (.273) | 0,76 (.030) |
| DB | 53,04 (2.088) | 38,38 (1.511) | 47,04 (1.852) | 7,90 (.311) | 12,55 (.494) | 10,90 (.429) | 6,94 (.273) | 0,76 (.030) |
| DC | 69,32 (2.729) | 54,84 (2.159) | 63,50 (2.500) | 7,90 (.311) | 12,55 (.494) | 10,90 (.429) | 6,94 (.273) | 0,76 (.030) |

- ♦ Connector footprint measured from the front shell.
- ♦♦ Connector footprint measured from the rear shell.

D*JK — 90° PC Tails and Metal Brackets — Standard Footprint .318♦ or .283 inch♦♦

Plug

Reader's Resource

For contact cavity arrangements, see page 224.
 For P.C. hole patterns, see page 273.
 For panel cutouts, see page 221.
 For hardware views (European), see page 227.
 For alternate bracket configuration (when connectors are supplied without boardlocks), see page 226.
 For pushfit/boardlock configuration, see page 225.

Part Numbers

| Shell Size | Layout | Bracket, #4-40 Nut | Bracket, #4-40 Nut, Boardlock |
|------------|--------|--------------------|-------------------------------|
| DE | 9 | DEJK9P*-1U7N | DEJK9P*-1U7N-146 |
| DA | 15 | DAJK15P*-1U7N | DAJK15P*-1U7N-146 |
| DB | 25 | DBJK25P*-1U7N | DBJK25P*-1U7N-146 |
| DC | 37 | DCJK37P*-1U7N | DCJK37P*-1U7N-146 |

Insert filter designator *. Example: DEJK9P4-1U7N-146 (For 1000 pF Filter Capacitance)
 Note: For performance class 1, add -A190. Example: DEJK9P4-1U7N-A190-146

| Filter Designator* | Filter Capacitance |
|--------------------|--------------------|
| 1 | 330 pF |
| 2 | 470 pF |
| 3 | 680 pF |
| 4 | 1000 pF |
| 5 | 1500 pF |

For electrical data, see page 106.



Boardlock removed for clarity

Dimensions

| Shell Size | A | B | C | D | E | F | W | W | L |
|------------|---------------|---------------|---------------|--------------|--------------|--------------|----------------|--------------|--------------|
| DE | ±0,38 (.015) | ±0,13 (.005) | ±0,13 (.005) | ±0,13 (.005) | ±0,38 (.015) | ±0,25 (.010) | ±0,368 (.0145) | ±0,41 (.016) | ±0,25 (.010) |
| DA | 30,81 (1.213) | 16,92 (.666) | 24,99 (.984) | 8,36 (.329) | 12,55 (.494) | 10,72 (.422) | 6,693 (.2635) | — | 0,76 (.030) |
| DB | 39,14 (1.541) | 25,25 (.994) | 33,32 (1.312) | 8,36 (.329) | 12,55 (.494) | 10,72 (.422) | 6,693 (.2635) | — | 0,76 (.030) |
| DC | 53,04 (2.088) | 38,96 (1.534) | 47,04 (1.852) | 8,36 (.329) | 12,55 (.494) | 10,82 (.426) | — | 6,84 (.269) | 0,99 (.039) |
| DC | 69,32 (2.729) | 55,42 (2.182) | 63,50 (2.500) | 8,36 (.329) | 12,55 (.494) | 10,82 (.426) | — | 6,84 (.269) | 0,99 (.039) |

- ♦ Connector footprint measured from the front shell.
- ♦♦ Connector footprint measured from the rear shell.

D*JK — 90° PC Tails and Metal Brackets — Standard Footprint .318♦ or .283 inch♦♦

Receptacle

Reader's Resource

For contact cavity arrangements, see page 224.
 For P.C. hole patterns, see page 273.
 For panel cutouts, see page 221.
 For hardware views (European), see page 227.
 For alternate bracket configuration (when connectors are supplied without boardlocks), see page 226.
 For pushfit/boardlock configuration, see page 225.

Part Numbers

| Shell Size | Layout | Bracket, #4-40 Nut | Bracket, #4-40 Nut, Boardlock |
|------------|--------|--------------------|-------------------------------|
| DE | 9 | DEJK9S*-1U7N | DEJK9S*-1U7N-146 |
| DA | 15 | DAJK15S*-1U7N | DAJK15S*-1U7N-146 |
| DB | 25 | DBJK25S*-1U7N | DBJK25S*-1U7N-146 |
| DC | 37 | DCJK37S*-1U7N | DCJK37S*-1U7N-146 |

Insert filter designator *. Example DEJK9S4-1U7N-146 (For 1000 pF Filter Capacitance)
 Note: For performance class 1, add -A190. Example: DEJK9S4-1U7N-A190-146

| Filter Designator* | Filter Capacitance |
|--------------------|--------------------|
| 1 | 330 pF |
| 2 | 470 pF |
| 3 | 680 pF |
| 4 | 1000 pF |
| 5 | 1500 pF |

For electrical data, see page 106.



Dimensions

| Shell Size | A | B | C | D | E | F | W | L |
|------------|---------------|---------------|---------------|--------------|--------------|--------------|--------------|--------------|
| | ±0,38 (.015) | ±0,13 (.005) | ±0,13 (.005) | ±0,13 (.005) | ±0,38 (.015) | ±0,25 (.010) | ±0,38 (.015) | ±0,25 (.010) |
| DE | 30,81 (1.213) | 16,33 (.643) | 24,99 (.984) | 7,90 (.311) | 12,55 (.494) | 10,90 (.429) | 6,94 (.273) | 0,76 (.030) |
| DA | 39,14 (1.541) | 24,66 (.971) | 33,32 (1.312) | 7,90 (.311) | 12,55 (.494) | 10,90 (.429) | 6,94 (.273) | 0,76 (.030) |
| DB | 53,04 (2.088) | 38,38 (1.511) | 47,04 (1.852) | 7,90 (.311) | 12,55 (.494) | 10,90 (.429) | 6,94 (.273) | 0,76 (.030) |
| DC | 69,32 (2.729) | 54,84 (2.159) | 63,50 (2.500) | 7,90 (.311) | 12,55 (.494) | 10,90 (.429) | 6,94 (.273) | 0,76 (.030) |

- ♦ Connector footprint measured from the front shell.
- ♦♦ Connector footprint measured from the rear shell.

D*JK — 90° PC Tails and Metal Brackets — European Footprint 10,2♦ or 9,4 mm♦♦

Plug



Part Numbers

| Bushing with Through Hole | Captive Nut #4-40 UNC | Captive Nut M3 | Post #4-40 UNC | Post M3 |
|---------------------------|-----------------------|----------------|----------------|---------------|
| DEJK9P*-1AFN | DEJK9P*-1A7N | DEJK9P*-1A9N | DEJK9P*-1A8N | DEJK9P*-1AHN |
| DAJK15P*-1AFN | DAJK15P*-1A7N | DAJK15P*-1A9N | DAJK15P*-1A8N | DAJK15P*-1AHN |
| DBJK25P*-1AFN | DBJK25P*-1A7N | DBJK25P*-1A9N | DBJK25P*-1A8N | DBJK25P*-1AHN |
| DCJK37P*-1AFN | DCJK37P*-1A7N | DCJK37P*-1A9N | DCJK37P*-1A8N | DCJK37P*-1AHN |

* Insert filter designator. Example: DEJK9P4-1A7N (For 1000 pF capacitance)
 Notes: For performance class 1 add -A190. Example: DEJK9P1-1AFN-A190
 For pushfit/boardlocks add -146. Example: DEJK9P1-1AFN-A190-146

Reader's Resource

- For contact cavity arrangements, see page 224.
- For P.C. hole patterns, see page 273.
- For panel cutouts, see page 221.
- For hardware views (European), see page 227.
- For alternate bracket configuration (when connectors are supplied without boardlocks), see page 226.
- For pushfit/boardlock configuration, see page 225.

| Filter Designator* | Filter Capacitance |
|--------------------|--------------------|
| 1 | 330 pF |
| 2 | 470 pF |
| 3 | 680 pF |
| 4 | 1000 pF |
| 5 | 1500 pF |

For electrical data, see page 106.



Dimensions

| Shell Size | A | B | C | D | E | F | W | W | L |
|------------|---------------|---------------|---------------|--------------|--------------|--------------|----------------|--------------|--------------|
| | ±0,38 (.015) | ±0,13 (.005) | ±0,13 (.005) | ±0,13 (.005) | ±0,38 (.015) | ±0,25 (.010) | ±0,368 (.0145) | ±0,41 (.016) | ±0,25 (.010) |
| DE | 30,81 (1.213) | 16,92 (.666) | 24,99 (.984) | 8,36 (.329) | 12,55 (.494) | 10,72 (.422) | 6,693 (.2635) | — | 0,76 (.030) |
| DA | 39,14 (1.541) | 25,25 (.994) | 33,32 (1.312) | 8,36 (.329) | 12,55 (.494) | 10,72 (.422) | 6,693 (.2635) | — | 0,76 (.030) |
| DB | 53,04 (2.088) | 38,96 (1.534) | 47,04 (1.852) | 8,36 (.329) | 12,55 (.494) | 10,82 (.426) | — | 6,84 (.269) | 0,99 (.039) |
| DC | 69,32 (2.729) | 55,42 (2.182) | 63,50 (2.500) | 8,36 (.329) | 12,55 (.494) | 10,82 (.426) | — | 6,84 (.269) | 0,99 (.039) |

- ♦ Connector footprint measured from the front shell.
- ♦♦ Connector footprint measured from the rear shell.

D*JK — 90° PC Tails and Metal Brackets — European Footprint 10,2♦ or 9,4 mm♦♦

Receptacle



Part Numbers

| Bushing with Through Hole | Captive Nut #4-40 UNC | Captive Nut M3 | Post #4-40 UNC | Post M3 |
|---------------------------|-----------------------|----------------|----------------|---------------|
| DEJK9S*-1AFN | DEJK9S*-1A7N | DEJK9S*-1A9N | DEJK9S*-1A8N | DEJK9S*-1AHN |
| DAJK15S*-1AFN | DAJK15S*-1A7N | DAJK15S*-1A9N | DAJK15S*-1A8N | DAJK15S*-1AHN |
| DBJK25S*-1AFN | DBJK25S*-1A7N | DBJK25S*-1A9N | DBJK25S*-1A8N | DBJK25S*-1AHN |
| DCJK37S*-1AFN | DCJK37S*-1A7N | DCJK37S*-1A9N | DCJK37S*-1A8N | DCJK37S*-1AHN |

* Insert filter designator. Example: DEJK9S4-1A7N (For 1000 pF capacitance)
 Notes: For performance class 1 add -A190. Example: DEJK9S1-1AFN-A190
 For pushfit/boardlocks add -146. Example: DEJK9S1-1AFN-A190-146

| Filter Designator* | Filter Capacitance |
|--------------------|--------------------|
| 1 | 330 pF |
| 2 | 470 pF |
| 3 | 680 pF |
| 4 | 1000 pF |
| 5 | 1500 pF |

For electrical data, see page 106.

Reader's Resource

For contact cavity arrangements, see page 224.
 For P.C. hole patterns, see page 273.
 For panel cutouts, see page 221.
 For hardware views (European), see page 227.
 For alternate bracket configuration (when connectors are supplied without boardlocks), see page 226.
 For pushfit/boardlock configuration, see page 225.



Dimensions

| Shell Size | A | B | C | D | E | F | W | K | L |
|------------|---------------|---------------|---------------|--------------|--------------|--------------|--------------|----------------|--------------|
| DE | ±0,38 (.015) | ±0,13 (.005) | ±0,13 (.005) | ±0,13 (.005) | ±0,38 (.015) | ±0,25 (.010) | ±0,38 (.015) | ±0,318 (.0125) | ±0,25 (.010) |
| DA | 30,81 (1.213) | 16,33 (.643) | 24,99 (.984) | 7,90 (.311) | 12,55 (.494) | 10,90 (.429) | 6,94 (.273) | 1,206 (.0475) | 0,76 (.030) |
| DB | 39,14 (1.541) | 24,66 (.971) | 33,32 (1.312) | 7,90 (.311) | 12,55 (.494) | 10,90 (.429) | 6,94 (.273) | 1,206 (.0475) | 0,76 (.030) |
| DC | 53,04 (2.088) | 38,38 (1.511) | 47,04 (1.852) | 7,90 (.311) | 12,55 (.494) | 10,90 (.429) | 6,94 (.273) | 1,206 (.0475) | 0,76 (.030) |
| | 69,32 (2.729) | 54,84 (2.159) | 63,50 (2.500) | 7,90 (.311) | 12,55 (.494) | 10,90 (.429) | 6,94 (.273) | 1,206 (.0475) | 0,76 (.030) |

♦ Connector footprint measured from the front shell.
 ♦♦ Connector footprint measured from the rear shell.

D*JK — 90° PC Tails & Plastic Brackets with Grounding Straps — European Footprint 10,2♦ or 9,4 mm♦♦

Plug



Part Numbers

| Bushing with Through Hole | Captive Nut #4-40 UNC | Captive Nut M3 | Post #4-40 UNC | Post M3 |
|---------------------------|-----------------------|----------------|----------------|---------------|
| DEJK9P*-1ADN | DEJK9P*-1AWN | DEJK9P*-1AVN | DEJK9P*-1AJN | DEJK9P*-1AGN |
| DAJK15P*-1ADN | DAJK15P*-1AWN | DAJK15P*-1AVN | DAJK15P*-1AJN | DAJK15P*-1AGN |
| DBJK25P*-1ADN | DBJK25P*-1AWN | DBJK25P*-1AVN | DBJK25P*-1AJN | DBJK25P*-1AGN |
| DCJK37P*-1ADN | DCJK37P*-1AWN | DCJK37P*-1AVN | DCJK37P*-1AJN | DCJK37P*-1AGN |

* Insert filter designator. Example: DEJK9P4-1AWN (For 1000 pF capacitance)
 Notes: For performance class 1 add -A190. Example: DEJK9P1-1ADN-A190
 For pushfit/boardlocks add -146. Example: DEJK9P1-1ADN-A190-146

Reader's Resource

For contact cavity arrangements, see page 224.
 For P.C. hole patterns, see page 273.
 For panel cutouts, see page 221.
 For hardware views (European), see page 227.
 For pushfit/boardlock configuration, see page 225.

| Filter Designator* | Filter Capacitance |
|--------------------|--------------------|
| 1 | 330 pF |
| 2 | 470 pF |
| 3 | 680 pF |
| 4 | 1000 pF |
| 5 | 1500 pF |

For electrical data, see page 106.



Dimensions

| Shell Size | A | B | C | D | E | F | W | W | L |
|------------|---------------|---------------|---------------|--------------|--------------|--------------|----------------|--------------|--------------|
| | ±0,38 (.015) | ±0,13 (.005) | ±0,13 (.005) | ±0,13 (.005) | ±0,38 (.015) | ±0,25 (.010) | ±0,368 (.0145) | ±0,41 (.016) | ±0,25 (.010) |
| DE | 30,81 (1.213) | 16,92 (.666) | 24,99 (.984) | 8,36 (.329) | 12,55 (.494) | 10,72 (.422) | 6,693 (.2635) | — | 0,76 (.030) |
| DA | 39,14 (1.541) | 25,25 (.994) | 33,32 (1.312) | 8,36 (.329) | 12,55 (.494) | 10,72 (.422) | 6,693 (.2635) | — | 0,76 (.030) |
| DB | 53,04 (2.088) | 38,96 (1.534) | 47,04 (1.852) | 8,36 (.329) | 12,55 (.494) | 10,82 (.426) | — | 6,84 (.269) | 0,99 (.039) |
| DC | 69,32 (2.729) | 55,42 (2.182) | 63,50 (2.500) | 8,36 (.329) | 12,55 (.494) | 10,82 (.426) | — | 6,84 (.269) | 0,99 (.039) |

- ♦ Connector footprint measured from the front shell.
- ♦♦ Connector footprint measured from the rear shell.

D*JK — 90° PC Tails & Plastic Brackets with Grounding Straps — European Footprint 10,2♦ or 9,4 mm♦♦

Receptacle



Part Numbers

| Bushing with Through Hole | Captive Nut #4-40 UNC | Captive Nut M3 | Post #4-40 UNC | Post M3 |
|---------------------------|-----------------------|----------------|----------------|---------------|
| DEJK9S*-1ADN | DEJK9S*-1AWN | DEJK9S*-1AVN | DEJK9S*-1AJN | DEJK9S*-1AGN |
| DAJK15S*-1ADN | DAJK15S*-1AWN | DAJK15S*-1AVN | DAJK15S*-1AJN | DAJK15S*-1AGN |
| DBJK25S*-1ADN | DBJK25S*-1AWN | DBJK25S*-1AVN | DBJK25S*-1AJN | DBJK25S*-1AGN |
| DCJK37S*-1ADN | DCJK37S*-1AWN | DCJK37S*-1AVN | DCJK37S*-1AJN | DCJK37S*-1AGN |

* Insert filter designator. Example: DEJK9S4-1AWN (For 1000 pF capacitance)
 Notes: For performance class 1 add -A190. Example: DEJKS1-1ADN-A190
 For pushfit/boardlocks add -146. Example: DEJK9P1-1ADN-A190-146

Reader's Resource

For contact cavity arrangements, see page 224.
 For P.C. hole patterns, see page 273.
 For panel cutouts, see page 221.
 For hardware views (European), see page 227.
 For pushfit/boardlock configuration, see page 225.

| Filter Designator* | Filter Capacitance |
|--------------------|--------------------|
| 1 | 330 pF |
| 2 | 470 pF |
| 3 | 680 pF |
| 4 | 1000 pF |
| 5 | 1500 pF |

For electrical data, see page 106.



Dimensions

| Shell Size | A | B | C | D | E | F | W | L |
|------------|---------------|---------------|---------------|--------------|--------------|--------------|--------------|--------------|
| | ±0,38 (.015) | ±0,13 (.005) | ±0,13 (.005) | ±0,13 (.005) | ±0,38 (.015) | ±0,25 (.010) | ±0,38 (.015) | ±0,25 (.010) |
| DE | 30,81 (1.213) | 16,33 (.643) | 24,99 (.984) | 7,90 (.311) | 12,55 (.494) | 10,90 (.429) | 6,94 (.273) | 0,76 (.030) |
| DA | 39,14 (1.541) | 24,66 (.971) | 33,32 (1.312) | 7,90 (.311) | 12,55 (.494) | 10,90 (.429) | 6,94 (.273) | 0,76 (.030) |
| DB | 53,04 (2.088) | 38,38 (1.511) | 47,04 (1.852) | 7,90 (.311) | 12,55 (.494) | 10,90 (.429) | 6,94 (.273) | 0,76 (.030) |
| DC | 69,32 (2.729) | 54,84 (2.159) | 63,50 (2.500) | 7,90 (.311) | 12,55 (.494) | 10,90 (.429) | 6,94 (.273) | 0,76 (.030) |

- ♦ Connector footprint measured from the front shell.
- ♦♦ Connector footprint measured from the rear shell.

D*JK — 90° PC Tails & Plastic Brackets — European Footprint 10,2♦ or 9,4 mm♦♦

Plug



Part Numbers

| Bushing with Through Hole | Captive Nut #4-40 UNC | Captive Nut M3 | Post #4-40 UNC | Post M3 |
|---------------------------|-----------------------|----------------|----------------|---------------|
| DEJK9P*-1A5N | DEJK9P*-1AUN | DEJK9P*-1ATN | DEJK9P*-1A6N | DEJK9P*-1APN |
| DAJK15P*-1A5N | DAJK15P*-1AUN | DAJK15P*-1ATN | DAJK15P*-1A6N | DAJK15P*-1APN |
| DBJK25P*-1A5N | DBJK25P*-1AUN | DBJK25P*-1ATN | DBJK25P*-1A6N | DBJK25P*-1APN |
| DCJK37P*-1A5N | DCJK37P*-1AUN | DCJK37P*-1ATN | DCJK37P*-1A6N | DCJK37P*-1APN |

* Insert filter designator. Example: DEJK9P4-1A5N (For 1000 pF filter capacitance)
 Notes: For performance class 1 add -A190. Example: DEJK9P1-1A5N-A190
 For pushfit/boardlocks add -146. Example: DEJK9P1-1A5N-A190-146

Reader's Resource

For contact cavity arrangements, see page 224.
 For P.C. hole patterns, see page 273.
 For panel cutouts, see page 221.
 For hardware views (European), see page 227.
 For pushfit/boardlock configuration, see page 225.

| Filter Designator* | Filter Capacitance |
|--------------------|--------------------|
| 1 | 330 pF |
| 2 | 470 pF |
| 3 | 680 pF |
| 4 | 1000 pF |
| 5 | 1500 pF |

For electrical data, see page 106.



Dimensions

| Shell Size | A ±0,38 (.015) | B ±0,13 (.005) | C ±0,13 (.005) | D ±0,13 (.005) | E ±0,38 (.015) | F ±0,25 (.010) | W ±0,37 (.015) | W ±0,41 (.016) | L ±0,25 (.010) |
|------------|----------------|----------------|----------------|----------------|----------------|----------------|----------------|----------------|----------------|
| DE | 30,81 (1.213) | 16,92 (.666) | 24,99 (.984) | 8,36 (.329) | 12,55 (.494) | 10,72 (.422) | 6,69 (.264) | — | 0,76 (.030) |
| DA | 39,14 (1.541) | 25,25 (.994) | 33,32 (1.312) | 8,36 (.329) | 12,55 (.494) | 10,72 (.422) | 6,69 (.264) | — | 0,76 (.030) |
| DB | 53,04 (2.088) | 38,96 (1.534) | 47,04 (1.852) | 8,36 (.329) | 12,55 (.494) | 10,82 (.426) | — | 6,84 (.269) | 0,99 (.039) |
| DC | 69,32 (2.729) | 55,42 (2.182) | 63,50 (2.500) | 8,36 (.329) | 12,55 (.494) | 10,82 (.426) | — | 6,84 (.269) | 0,99 (.039) |

- ♦ Connector footprint measured from the front shell.
- ♦♦ Connector footprint measured from the rear shell.

D*JK — 90° PC Tails and Plastic Brackets — European Footprint 10,2♦ or 9,4 mm♦♦

Receptacle



Part Numbers

| Bushing with Through Hole | Captive Nut #4-40 UNC | Captive Nut M3 | Post #4-40 UNC | Post M3 |
|---------------------------|-----------------------|----------------|----------------|---------------|
| DEJK9S*-1A5N | DEJK9S*-1AUN | DEJK9S*-1ATN | DEJK9S*-1A6N | DEJK9S*-1APN |
| DAJK15S*-1A5N | DAJK15S*-1AUN | DAJK15S*-1ATN | DAJK15S*-1A6N | DAJK15S*-1APN |
| DBJK25S*-1A5N | DBJK25S*-1AUN | DBJK25S*-1ATN | DBJK25S*-1A6N | DBJK25S*-1APN |
| DCJK37S*-1A5N | DCJK37S*-1AUN | DCJK37S*-1ATN | DCJK37S*-1A6N | DCJK37S*-1APN |

* Insert filter designator. Example: DEJK9S4-1A5N (for 1000 pF filter capacitance)

Notes: For performance class 1 add -A190. Example: DEJK9S1-1A5N-A190

For pushfit/boardlocks add -146. Example: DEJK9S1-1A5N-A190-146

Reader's Resource

For contact cavity arrangements, see page 224.
 For P.C. hole patterns, see page 273.
 For panel cutouts, see page 221.
 For hardware views (European), see page 227.
 For pushfit/boardlock configuration, see page 225.

| Filter Designator* | Filter Capacitance |
|--------------------|--------------------|
| 1 | 330 pF |
| 2 | 470 pF |
| 3 | 680 pF |
| 4 | 1000 pF |
| 5 | 1500 pF |

For electrical data, see page 106.



Dimensions

| Shell Size | A | B | C | D | E | F | W | L |
|------------|---------------|---------------|---------------|--------------|--------------|--------------|--------------|--------------|
| | ±0,38 (.015) | ±0,13 (.005) | ±0,13 (.005) | ±0,13 (.005) | ±0,38 (.015) | ±0,25 (.010) | ±0,38 (.015) | ±0,25 (.010) |
| DE | 30,81 (1.213) | 16,33 (.643) | 24,99 (.984) | 7,90 (.311) | 12,55 (.494) | 10,90 (.429) | 6,94 (.273) | 0,76 (.030) |
| DA | 39,14 (1.541) | 24,66 (.971) | 33,32 (1.312) | 7,90 (.311) | 12,55 (.494) | 10,90 (.429) | 6,94 (.273) | 0,76 (.030) |
| DB | 53,04 (2.088) | 38,38 (1.511) | 47,04 (1.852) | 7,90 (.311) | 12,55 (.494) | 10,90 (.429) | 6,94 (.273) | 0,76 (.030) |
| DC | 69,32 (2.729) | 54,84 (2.159) | 63,50 (2.500) | 7,90 (.311) | 12,55 (.494) | 10,90 (.429) | 6,94 (.273) | 0,76 (.030) |

- ♦ Connector footprint measured from the front shell.
- ♦♦ Connector footprint measured from the rear shell.

D*JK — Straight P.C. Tails

Plug



Part Numbers

| Shell Size | Layout | Through Hole | Clinch Nut #4-40 UNC | Clinch Nut M3 | Pushfit/Boardlock #4-40 UNC | Pushfit/Boardlock M3 |
|------------|--------|--------------|----------------------|---------------|-----------------------------|----------------------|
| DE | 9 | DEJK9P*-OL4 | DEJKE9P*-OL4 | DEJKX9P*-OL4 | DEJKE9P*-OL4-146 | DEJKX9P*-OL4-146 |
| DA | 15 | DAJK15P*-OL4 | DAJKE15P*-OL4 | DAJKX15P*-OL4 | DAJKE15P*-OL4-146 | DAJKX15P*-OL4-146 |
| DB | 25 | DBJK25P*-OL4 | DBJKE25P*-OL4 | DBJKX25P*-OL4 | DBJKE25P*-OL4-146 | DBJKX25P*-OL4-146 |
| DC | 37 | DCJK37P*-OL4 | DCJKE37P*-OL4 | DCJKX37P*-OL4 | DCJKE37P*-OL4-146 | DCJKX37P*-OL4-146 |
| DD | 50 | DDJK50P*-OL4 | DDJKE50P*-OL4 | DDJKX50P*-OL4 | DDJKE50P*-OL4-146 | DDJKX50P*-OL4-146 |

* Insert filter designator. Example: DEJK9P4-OL4 (for 1000 pF filter capacitance)
 Note: For performance class 1 add -A190. Example: DEJK9P1-OL4-A190

Reader's Resource

For contact cavity arrangements, see page 224.
 For P.C. hole patterns, see page 274.
 For panel cutouts, see page 221.
 For Hardware views (European), see page 227.
 For pushfit/boardlock configuration, see page 225.

| Filter Designator* | Filter Capacitance |
|--------------------|--------------------|
| 1 | 330 pF |
| 2 | 470 pF |
| 3 | 680 pF |
| 4 | 1000 pF |
| 5 | 1500 pF |

For electrical data, see page 106.

Engaging Face



DD Configuration



Dimensions

| Shell Size | A ±0,38 (.015) | B ±0,13 (.005) | C ±0,13 (.005) | D ±0,13 (.005) | E ±0,38 (.015) | F ±0,25 (.010) | W ±0,368 (.0145) | W ±0,41 (.016) | L ±0,25 (.010) |
|------------|-------------------|-------------------|-------------------|-------------------|-------------------|-------------------|---------------------|-------------------|-------------------|
| DE | 30,81 (1.213) | 16,92 (.666) | 24,99 (.984) | 8,36 (.329) | 12,55 (.494) | 10,72 (.422) | 6,693 (.2635) | — | 0,76 (.030) |
| DA | 39,14 (1.541) | 25,25 (.994) | 33,32 (1.312) | 8,36 (.329) | 12,55 (.494) | 10,72 (.422) | 6,693 (.2635) | — | 0,76 (.030) |
| DB | 53,04 (2.088) | 38,96 (1.534) | 47,04 (1.852) | 8,36 (.329) | 12,55 (.494) | 10,82 (.426) | — | 6,84 (.269) | 0,99 (.039) |
| DC | 69,32 (2.729) | 55,42 (2.182) | 63,50 (2.500) | 8,36 (.329) | 12,55 (.494) | 10,82 (.426) | — | 6,84 (.269) | 0,99 (.039) |
| DD | 66,93 (2.635) | 52,81 (2.079) | 61,11 (2.406) | 11,07 (.439) | 15,37 (.607) | 10,82 (.426) | — | 6,84 (.269) | 0,99 (.039) |

D*JK — Straight P.C. Tails

Receptacle



Reader's Resource

For contact cavity arrangements, see page 224.
 For P.C. hole patterns, see page 274.
 For panel cutouts, see page 221.
 For Hardware views (European), see page 227.
 For pushfit/boardlock configuration, see page 225.

Part Numbers

| Shell Size | Layout | Through Hole | Clinch Nut #4-40 UNC | Clinch Nut M3 | Pushfit/Boardlock #4-40 UNC | Pushfit/Boardlock M3 |
|------------|--------|--------------|----------------------|---------------|-----------------------------|----------------------|
| DE | 9 | DEJK9S*-OL4 | DEJKE9S*-OL4 | DEJKX9S*-OL4 | DEJKE9S*-OL4-146 | DEJKX9S*-OL4-146 |
| DA | 15 | DAJK15S*-OL4 | DAJKE15S*-OL4 | DAJKX15S*-OL4 | DAJKE15S*-OL4-146 | DAJKX15S*-OL4-146 |
| DB | 25 | DBJK25S*-OL4 | DBJKE25S*-OL4 | DBJKX25S*-OL4 | DBJKE25S*-OL4-146 | DBJKX25S*-OL4-146 |
| DC | 37 | DCJK37S*-OL4 | DCJKE37S*-OL4 | DCJKX37S*-OL4 | DCJKE37S*-OL4-146 | DCJKX37S*-OL4-146 |

* Insert filter designator. Example: DEJK9S4-OL4 (for 1000 pF filter capacitance)
 Note: For performance class 1 add -A190. Example: DEJK9S1-OL4-A190

| Filter Designator* | Filter Capacitance |
|--------------------|--------------------|
| 1 | 330 pF |
| 2 | 470 pF |
| 3 | 680 pF |
| 4 | 1000 pF |
| 5 | 1500 pF |

For electrical data, see page 106.



Dimensions

| Shell Size | A ±0,38 (.015) | B ±0,13 (.005) | C ±0,13 (.005) | D ±0,13 (.005) | E ±0,38 (.015) | F ±0,25 (.010) | W ±0,38 (.015) | L ±0,25 (.010) |
|------------|-------------------|-------------------|-------------------|-------------------|-------------------|-------------------|-------------------|-------------------|
| DE | 30,81 (1.213) | 16,33 (.643) | 24,99 (.984) | 7,90 (.311) | 12,55 (.494) | 10,90 (.429) | 6,94 (.273) | 0,76 (.030) |
| DA | 39,14 (1.541) | 24,66 (.971) | 33,32 (1.312) | 7,90 (.311) | 12,55 (.494) | 10,90 (.429) | 6,94 (.273) | 0,76 (.030) |
| DB | 53,04 (2.088) | 38,38 (1.511) | 47,04 (1.852) | 7,90 (.311) | 12,55 (.494) | 10,90 (.429) | 6,94 (.273) | 0,76 (.030) |
| DC | 69,32 (2.729) | 54,84 (2.159) | 63,50 (2.500) | 7,90 (.311) | 12,55 (.494) | 10,90 (.429) | 6,94 (.273) | 0,76 (.030) |

D*JT — Solder Cup

Plug



Part Numbers

| Shell Size | Layout | Through Hole | Clinch Nut #4-40 UNC | Clinch Nut M3 |
|------------|--------|--------------|----------------------|---------------|
| DE | 9 | DEJT9P* | DEJTE9P* | DEJTX9P* |
| DA | 15 | DAJT15P* | DAJTE15P* | DAJTX15P* |
| DB | 25 | DBJT25P* | DBJTE25P* | DBJTX25P* |
| DC | 37 | DCJT37P* | DCJTE37P* | DCJTX37P* |

* Insert filter designator. Example: DCJT37P4 (for 2000 pF filter capacitance)
 Note: For performance class 1 add -A190. Example: DCJT37P1-A190

Reader's Resource

For contact cavity arrangements, see page 224.
 For panel cutouts, see page 221.
 For hardware views (European), see page 227.

| Filter Designator* | Filter Capacitance |
|--------------------|--------------------|
| 1 | 1000 pF |
| 2 | 500 pF |
| 3 | 250 pF |
| 4 | 2000 pF |
| 5 | 5000 pF |

For electrical data, see page 107.



Dimensions

| Shell Size | A | B | C | D | E | F | W | W | L |
|------------|---------------|---------------|---------------|--------------|--------------|--------------|--------------|--------------|--------------|
| | ±0,38 (.015) | ±0,13 (.005) | ±0,13 (.005) | ±0,13 (.005) | ±0,38 (.015) | ±0,25 (.010) | ±0,37 (.015) | ±0,41 (.016) | ±0,25 (.010) |
| DE | 30,81 (1.213) | 16,92 (.666) | 24,99 (.984) | 8,36 (.329) | 12,55 (.494) | 10,72 (.422) | 6,69 (.264) | — | 0,76 (.030) |
| DA | 39,14 (1.541) | 25,25 (.994) | 33,32 (1.312) | 8,36 (.329) | 12,55 (.494) | 10,72 (.422) | 6,69 (.264) | — | 0,76 (.030) |
| DB | 53,04 (2.088) | 38,96 (1.534) | 47,04 (1.852) | 8,36 (.329) | 12,55 (.494) | 10,82 (.426) | — | 6,84 (.269) | 0,99 (.039) |
| DC | 69,32 (2.729) | 55,42 (2.182) | 63,50 (2.500) | 8,36 (.329) | 12,55 (.494) | 10,82 (.426) | — | 6,84 (.269) | 0,99 (.039) |

D*JT — Solder Cup

Receptacle



Reader's Resource

For contact cavity arrangements, see page 224.
 For panel cutouts, see page 221.
 For hardware views (European), see page 227.

Part Numbers

| Shell Size | Layout | Through Hole | Clinch Nut #4-40 UNC | Clinch Nut M3 |
|------------|--------|--------------|----------------------|---------------|
| DE | 9 | DEJT9S* | DEJTE9S* | DEJTX9S* |
| DA | 15 | DAJT15S* | DAJTE15S* | DAJTX15S* |
| DB | 25 | DBJT25S* | DBJTE25S* | DBJTX25S* |
| DC | 37 | DCJT37S* | DCJTE37S* | DCJTX37S* |

* Insert filter designator. Example: DEJT9S4 (for 2000 pF filter capacitance)
 Note: For performance class 1 add -A190. Example: DEJT9S1-A190

| Filter Designator* | Filter Capacitance |
|--------------------|--------------------|
| 1 | 1000 pF |
| 2 | 500 pF |
| 3 | 250 pF |
| 4 | 2000 pF |
| 5 | 5000 pF |

For electrical data, see page 107.



Dimensions

| Shell Size | A | B | C | D | E | F | W | L |
|------------|---------------|---------------|---------------|--------------|--------------|--------------|--------------|--------------|
| | ±0,38 (.015) | ±0,13 (.005) | ±0,13 (.005) | ±0,13 (.005) | ±0,38 (.015) | ±0,25 (.010) | ±0,38 (.015) | ±0,25 (.010) |
| DE | 30,81 (1.213) | 16,33 (.643) | 24,99 (.984) | 7,90 (.311) | 12,55 (.494) | 10,90 (.429) | 6,94 (.273) | 0,76 (.030) |
| DA | 39,14 (1.541) | 24,66 (.971) | 33,32 (1.312) | 7,90 (.311) | 12,55 (.494) | 10,90 (.429) | 6,94 (.273) | 0,76 (.030) |
| DB | 53,04 (2.088) | 38,38 (1.511) | 47,04 (1.852) | 7,90 (.311) | 12,55 (.494) | 10,90 (.429) | 6,94 (.273) | 0,76 (.030) |
| DC | 69,32 (2.729) | 54,84 (2.159) | 63,50 (2.500) | 7,90 (.311) | 12,55 (.494) | 10,90 (.429) | 6,94 (.273) | 0,76 (.030) |

D*JT Combo — High Power 90°

Plug

Reader's Resource

For contact cavity arrangements, see page 222.
 For P.C. hole patterns, see page 250.
 For panel cutouts, see page 221.
 For hardware views (European), see page 227.

Part Numbers

| Filter Capacitance | Through Hole | Clinch Nut #4-40 UNC | Clinch Nut M3 |
|--------------------|----------------|----------------------|-----------------|
| 1000 pF | DAJT3W3P1-1A0N | DAJTE3W3P1-1A0N | DAJTX3W3P1-1A0N |
| 1500 pF | DAJT3W3P6-1A0N | DAJTE3W3P6-1A0N | DAJTX3W3P6-1A0N |
| 5000 pF | DAJT3W3P5-1A0N | DAJTE3W3P5-1A0N | DAJTX3W3P5-1A0N |
| 47000 pF | DAJT3W3P9-1A0N | DAJTE3W3P9-1A0N | DAJTX3W3P9-1A0N |

Note: For performance class 1 add -A190. Example: DAJT3WK3P6-1A0N-A190

Part Numbers — Keyed Configuration

| Filter Capacitance | Through Hole | Clinch Nut #4-40 UNC | Clinch Nut M3 |
|--------------------|-----------------|----------------------|------------------|
| 1000 pF | DAJT3WK3P1-1A0N | DAJTE3WK3P1-1A0N | DAJTX3WK3P1-1A0N |
| 1500 pF | DAJT3WK3P6-1A0N | DAJTE3WK3P6-1A0N | DAJTX3WK3P6-1A0N |
| 5000 pF | DAJT3WK3P5-1A0N | DAJTE3WK3P5-1A0N | DAJTX3WK3P5-1A0N |
| 47000 pF | DAJT3WK3P9-1A0N | DAJTE3WK3P9-1A0N | DAJTX3WK3P9-1A0N |

Note: For performance class 1 add -A190. Example: DAJT3WK3P6-1A0N-A190
 For electrical data, see page 107.



Dimensions

| Shell Size | A ±0,38 (.015) | B ±0,13 (.005) | C ±0,13 (.005) | D ±0,13 (.005) | E ±0,38 (.015) | F ±0,25 (.010) | W ±0,368 (.0145) | L ±0,25 (.010) |
|------------|-------------------|-------------------|-------------------|-------------------|-------------------|-------------------|---------------------|-------------------|
| DA | 39,14 (1.541) | 25,25 (.994) | 33,32 (1.312) | 8,36 (.329) | 12,55 (.494) | 10,72 (.422) | 6,693 (.2635) | 0,76 (.030) |

D*JT Combo — High Power 90°

Receptacle

Reader's Resource

For contact cavity arrangements, see page 223.
 For P.C. hole patterns, see page 252.
 For panel cutouts, see page 221.
 For hardware views (European), see page 227.

Part Numbers

| Filter Capacitance | Through Hole | Clinch Nut #4-40 UNC | Clinch Nut M3 |
|--------------------|----------------|----------------------|-----------------|
| 1000 pF | DAJT3W3S1-1A0N | DAJTE3W3S1-1A0N | DAJTX3W3S1-1A0N |
| 1500 pF | DAJT3W3S6-1A0N | DAJTE3W3S6-1A0N | DAJTX3W3S6-1A0N |
| 5000 pF | DAJT3W3S5-1A0N | DAJTE3W3S5-1A0N | DAJTX3W3S5-1A0N |
| 47000 pF | DAJT3W3S9-1A0N | DAJTE3W3S9-1A0N | DAJTX3W3S9-1A0N |

Note: For performance class 1 add -A190. Example: DAJT3W3S9-1A0N-A190

Part Numbers — Keyed Configuration

| Filter Capacitance | Through Hole | Clinch Nut #4-40 UNC | Clinch Nut M3 |
|--------------------|-----------------|----------------------|------------------|
| 1000 pF | DAJT3WK3S1-1A0N | DAJTE3WK3S1-1A0N | DAJTX3WK3S1-1A0N |
| 1500 pF | DAJT3WK3S6-1A0N | DAJTE3WK3S6-1A0N | DAJTX3WK3S6-1A0N |
| 5000 pF | DAJT3WK3S5-1A0N | DAJTE3WK3S5-1A0N | DAJTX3WK3S5-1A0N |
| 47000pF | DAJT3WK3S9-1A0N | DAJTE3WK3S9-1A0N | DAJTX3WK3S9-1A0N |

Note: For performance class 1 add -A190. Example: DAJT3WK3S9-1A0N-A190
 For electrical data, see page 107.



Dimensions

| | A | B | C | D | E | F | W | L |
|------------|---------------|--------------|---------------|--------------|--------------|--------------|--------------|--------------|
| Shell Size | ±0,38 (.015) | ±0,13 (.005) | ±0,13 (.005) | ±0,13 (.005) | ±0,38 (.015) | ±0,25 (.010) | ±0,38 (.015) | ±0,25 (.010) |
| DA | 39,14 (1.541) | 24,66 (.971) | 33,32 (1.312) | 7,90 (.311) | 12,55 (.494) | 10,90 (.429) | 6,94 (.273) | 0,76 (.030) |

D*JT Combo — High Power Straight

Plug



Reader's Resource

For contact cavity arrangements, see page 222.
 For P.C. hole patterns, see page 254.
 For panel cutouts, see page 221.
 For hardware views (European), see page 227.

Part Numbers

| Filter Capacitance | Through Hole | Clinch Nut #4-40 UNC | Clinch Nut M3 |
|--------------------|---------------|----------------------|----------------|
| 1000 pF | DAJT3W3P1-OL4 | DAJTE3W3P1-OL4 | DAJTX3W3P1-OL4 |
| 1500 pF | DAJT3W3P6-OL4 | DAJTE3W3P6-OL4 | DAJTX3W3P6-OL4 |
| 5000 pF | DAJT3W3P5-OL4 | DAJTE3W3P5-OL4 | DAJTX3W3P5-OL4 |
| 47000 pF | DAJT3W3P9-OL4 | DAJTE3W3P9-OL4 | DAJTX3W3P9-OL4 |

Note: For performance class 1 add -A190. Example: DAJT3W3P6-OL4-A190

Part Numbers — Keyed Configuration

| Filter Capacitance | Through Hole | Clinch Nut #4-40 UNC | Clinch Nut M3 |
|--------------------|----------------|----------------------|-----------------|
| 1000 pF | DAJT3WK3P1-OL4 | DAJTE3WK3P1-OL4 | DAJTX3WK3P1-OL4 |
| 1500 pF | DAJT3WK3P6-OL4 | DAJTE3WK3P6-OL4 | DAJTX3WK3P6-OL4 |
| 5000 pF | DAJT3WK3P5-OL4 | DAJTE3WK3P5-OL4 | DAJTX3WK3P5-OL4 |
| 47000 pF | DAJT3WK3P9-OL4 | DAJTE3WK3P9-OL4 | DAJTX3WK3P9-OL4 |

Note: For performance class 1 add -A190. Example: DAJT3WK3P6-OL4-A190
 For electrical data, see page 107.



Dimensions

| Shell Size | A | B | C | D | E | F | W | L |
|------------|---------------|--------------|---------------|--------------|--------------|--------------|----------------|--------------|
| | ±0,38 (.015) | ±0,13 (.005) | ±0,13 (.005) | ±0,13 (.005) | ±0,38 (.015) | ±0,25 (.010) | ±0,368 (.0145) | ±0,25 (.010) |
| DA | 39,14 (1.541) | 25,25 (.994) | 33,32 (1.312) | 8,36 (.329) | 12,55 (.494) | 10,72 (.422) | 6,693 (.2635) | 0,76 (.030) |

D*JT Combo — High Power Straight

Receptacle

Reader's Resource

For contact cavity arrangements, see page 223.
 For P.C. hole patterns, see page 257.
 For panel cutouts, see page 221.
 For hardware views (European), see page 227.

Part Numbers

| Filter Capacitance | Through Hole | Clinch Nut #4-40 UNC | Clinch Nut M3 |
|--------------------|---------------|----------------------|----------------|
| 1000 pF | DAJT3W3S1-OL4 | DAJTE3W3S1-OL4 | DAJTX3W3S1-OL4 |
| 1500 pF | DAJT3W3S6-OL4 | DAJTE3W3S6-OL4 | DAJTX3W3S6-OL4 |
| 5000 pF | DAJT3W3S5-OL4 | DAJTE3W3S5-OL4 | DAJTX3W3S5-OL4 |
| 47000 pF | DAJT3W3S9-OL4 | DAJTE3W3S9-OL4 | DAJTX3W3S9-OL4 |

Note: For performance class 1 add -A190. Example: DAJT3W3S6-OL4-A190

Part Numbers — Keyed Configuration

| Filter Capacitance | Through Hole | Clinch Nut #4-40 UNC | Clinch Nut M3 |
|--------------------|----------------|----------------------|-----------------|
| 1000 pF | DAJT3WK3S1-OL4 | DAJTE3WK3S1-OL4 | DAJTX3WK3S1-OL4 |
| 1500 pF | DAJT3WK3S6-OL4 | DAJTE3WK3S6-OL4 | DAJTX3WK3S6-OL4 |
| 5000 pF | DAJT3WK3S5-OL4 | DAJTE3WK3S5-OL4 | DAJTX3WK3S5-OL4 |
| 47000 pF | DAJT3WK3S9-OL4 | DAJTE3WK3S9-OL4 | DAJTX3WK3S9-OL4 |

Note: For performance class 1 add -A190. Example: DAJT3WK3S-OL4-A190
 For electrical data, see page 107.



Dimensions

| | A | B | C | D | E | F | W | L |
|------------|---------------|--------------|---------------|--------------|--------------|--------------|--------------|--------------|
| Shell Size | ±0,38 (.015) | ±0,13 (.005) | ±0,13 (.005) | ±0,13 (.005) | ±0,38 (.015) | ±0,25 (.010) | ±0,38 (.015) | ±0,25 (.010) |
| DA | 39,14 (1.541) | 24,66 (.971) | 33,32 (1.312) | 7,90 (.311) | 12,55 (.494) | 10,90 (.429) | 6,94 (.273) | 0,76 (.030) |

D*JT Combo — High Power Solder Cup

Plug



Reader's Resource

For contact cavity arrangements, see page 222.
 For panel cutouts, see page 221.
 For hardware views (European), see page 227.

Part Numbers

| Filter Capacitance | Through Hole | Clinch Nut #4-40 UNC | Clinch Nut M3 |
|--------------------|--------------|----------------------|---------------|
| 1000 pF | DAJT3W3P1 | DAJTE3W3P1 | DAJTX3W3P1 |
| 1500 pF | DAJT3W3P6 | DAJTE3W3P6 | DAJTX3W3P6 |
| 5000 pF | DAJT3W3P5 | DAJTE3W3P5 | DAJTX3W3P5 |
| 47000 pF | DAJT3W3P9 | DAJTE3W3P9 | DAJTX3W3P9 |

Note: For performance class 1 add -A190. Example: DAJT3W3P6-A190

Part Numbers – Keyed Configuration

| Filter Capacitance | Through Hole | Clinch Nut #4-40 UNC | Clinch Nut M3 |
|--------------------|--------------|----------------------|---------------|
| 1000 pF | DAJT3WK3P1 | DAJTE3WK3P1 | DAJTX3WK3P1 |
| 1500 pF | DAJT3WK3P6 | DAJTE3WK3P6 | DAJTX3WK3P6 |
| 5000 pF | DAJT3WK3P5 | DAJTE3WK3P5 | DAJTX3WK3P5 |
| 47000 pF | DAJT3WK3P9 | DAJTE3WK3P9 | DAJTX3WK3P9 |

Note: For performance class 1 add -A190. Example: DAJT3WK3P6-A190
 For electrical data, see page 107.

Engaging Face



Keyed Configuration

Engaging Face



Dimensions

| Shell Size | A | B | C | D | E | F | W | L |
|------------|---------------|--------------|---------------|--------------|--------------|--------------|----------------|--------------|
| DA | ±0,38 (.015) | ±0,13 (.005) | ±0,13 (.005) | ±0,13 (.005) | ±0,38 (.015) | ±0,25 (.010) | ±0,368 (.0145) | ±0,25 (.010) |
| | 39,14 (1.541) | 25,25 (.994) | 33,32 (1.312) | 8,36 (.329) | 12,55 (.494) | 10,72 (.422) | 6,693 (.2635) | 0,76 (.030) |

D*JT Combo — High Power Solder Cup

Receptacle



Reader's Resource

For contact cavity arrangements, see page 223.
 For panel cutouts, see page 221.
 For hardware views (European), see page 227.

Part Numbers

| Filter Capacitance | Through Hole | Clinch Nut #4-40 UNC | Clinch Nut M3 |
|--------------------|--------------|----------------------|---------------|
| 1000 pF | DAJT3W3S1 | DAJTE3W3S1 | DAJTX3W3S1 |
| 1500 pF | DAJT3W3S6 | DAJTE3W3S6 | DAJTX3W3S6 |
| 5000 pF | DAJT3W3S5 | DAJTE3W3S5 | DAJTX3W3S5 |
| 47000 pF | DAJT3W3S9 | DAJTE3W3S9 | DAJTX3W3S9 |

Note: For performance class 1 add -A190. Example: DAJT3W3S6-A190

Part Numbers — Keyed Configuration

| Filter Capacitance | Through Hole | Clinch Nut #4-40 UNC | Clinch Nut M3 |
|--------------------|--------------|----------------------|---------------|
| 1000 pF | DAJT3WK3S1 | DAJTE3WK3S1 | DAJTX3WK3S1 |
| 1500 pF | DAJT3WK3S6 | DAJTE3WK3S6 | DAJTX3WK3S6 |
| 5000 pF | DAJT3WK3S5 | DAJTE3WK3S5 | DAJTX3WK3S5 |
| 47000 pF | DAJT3WK3S9 | DAJTE3WK3S9 | DAJTX3WK3S9 |

Note: For performance class 1 add -A190. Example: DAJT3WK3S6-A190
 For electrical data, see page 107.



Dimensions

| Shell Size | A | B | C | D | E | F | W | L |
|------------|---------------|--------------|---------------|--------------|--------------|--------------|--------------|--------------|
| | ±0,38 (.015) | ±0,13 (.005) | ±0,13 (.005) | ±0,13 (.005) | ±0,38 (.015) | ±0,25 (.010) | ±0,38 (.015) | ±0,25 (.010) |
| DA | 39,14 (1.541) | 24,66 (.971) | 33,32 (1.312) | 7,90 (.311) | 12,55 (.494) | 10,90 (.429) | 6,94 (.273) | 0,76 (.030) |

| Selection Index | Page |
|--|------|
| Military/High Reliability | |
| An Introduction | 130 |
| Standard Layout | |
| 90° PC Tail with Plastic Bracket | 132 |
| 90° PC Tail | 134 |
| Straight PC Tail | 136 |
| Wrap Post Connector | 138 |
| Solder Cup Connector | 140 |
| 24308-Style Cross Reference | 142 |
| MIL-C-39028 Crimp Contacts | 143 |
| HE501/D*M Cross Reference | 144 |
| MIL-24308 Test Data | 145 |
| Combo D® PCB Connectors with Coaxial 75 Ohm Contacts (50 Ohm Option) | |
| Coaxial 90° (Sizes DE-DC) | 146 |
| Coaxial 90° (Size DD) | 148 |
| Coaxial Straight (Sizes DE-DC) | 150 |
| Coaxial Straight (Size DD) | 152 |
| Combo D® PCB Connectors with High Power Contacts | |
| 40 A High Power 90° (Sizes DE-DC) | 154 |
| 40 A High Power 90° (Size DD) | 156 |
| 40 A High Power Straight (Sizes DE-DC) | 158 |
| 40 A High Power Straight (Size DD) | 160 |
| Combo D® PCB Connectors with High Voltage Contacts | |
| High Voltage Straight (Sizes DE-DC) | 162 |
| High Voltage Straight (Size DD) | 164 |
| Combo D® PCB Connectors with (Size 20) Signal Contacts Only | |
| Cable Solder Cup (Sizes DE-DD) | 166 |

ITT Cannon Military/High Reliability D Subminiature connectors are used in many applications, including aerospace, transportation, communication systems, information systems and test equipment. Being the inventor of the D Subminiature connector, ITT Cannon is able to use its extensive design expertise and high quality manufacturing processes to insure the optimum performance and reliability.

The D Subminiature connectors with fixed contacts in solder cup, straight and 90° PC contact terminations are designed to be comparable to MIL-C-24308 (see cross reference, pages 142-143). These high-reliability D Subminiature connectors are the finest quality connectors available at the most competitive prices in the market.

Applications:

- Aerospace
- Transportation
- Communication Systems
- Information Systems
- Test Equipment



Product Features

Suitable for a variety of cable and printed circuit board options

Solder cup version accommodates wire size 20 AWG maximum

5 A standard current rating
Clinch Nut and Float Mount Options

Specifications

| | | | |
|--|---------------------------------------|--|---|
| Temperature Rating | -55°C to 125°C | Coaxial VSWR | Less than 1.30 + .03F for F up to 500 MHz |
| Signal Contact Current Rating | 7.5 A current capacity | Coaxial Insertion Loss | .3dB loss at 500 MHz |
| Signal Contact Resistance | 55 millivolt max. at 7.5 test current | High Power Current Rating | Up to 40 A |
| Signal Contact Dielectric Withstanding Voltage | 1250 VAC at Sea Level | High Power Dielectric Withstanding Voltage | 1000 VAC at Sea Level |
| Coaxial Current Rating | 5 A | High Voltage Current Rating | 5 A |
| Coaxial Dielectric Withstanding Voltage | 1000 VAC at Sea Level | High Voltage Contact Dielectric Withstanding Voltage | 2800 V at Sea Level |
| Coaxial Impedance | 75 Ω or 50 Ω | | |

Materials and Finishes

| Description | Material | Finish/Treatment |
|---------------------------|-------------------------------------|---|
| Shell | Steel | Yellow Chromate over Zinc (Cadmium available upon request; order code -A101) |
| Insulator | Polyester, UL 94V-0, Color: Green | None |
| Contacts (Military) | Copper Alloy | 50 microinches of Gold over Nickel in mating area, Gold over Nickel on balance |
| Contacts (Commercial) | Copper Alloy | Gold over Nickel on mating area, Tin on balance |
| Dual Float Mount Hardware | Stainless Steel | Passivated |
| Clinch Nut Hardware | Stainless Steel with plastic insert | Passivated |
| Standoff | Stainless Steel | Passivated |
| Plastic Bracket | Thermoplastic, UL 94V-0 | None |
| Metal Bracket | Steel | Zinc (Tin if boardlocks are attached) |

Coaxial/High Power/High Voltage Contact Assemblies

| | | |
|-------------------------------|---------------|------------------|
| Contacts and Outer Shells | Copper Alloy | Gold over Nickel |
| Ring, Retaining | Copper Alloy | Nickel |
| Insulator (Coaxial Only) | Teflon | None |
| Insulator (High Voltage Only) | Thermoplastic | None |

90° PC Tail with Plastic Bracket

Plug



Part Numbers

| | | Military Part Numbers | | | | | |
|------------|--------|-----------------------|------------------|------------------|--------------------|------------------|------------------|
| | | Ø Y 0,76 (.030) | | | Ø Y 1,02 (.040) | | |
| Shell Size | Layout | X 3,23 (.127) | X 4,01 (.158) | X 4,65 (.183) | X 3,23 (.127) | X 4,01 (.158) | X 4,65 (.183) |
| DE | 9 | DEM9PD | DEM9PL | DEM9PS | DEM9PA | DEM9PG | DEM9PW |
| DA | 15 | DAM15PD | DAM15PL | DAM15PS | DAM15PA | DAM15PG | DAM15PW |
| DB | 25 | DBM25PD | DBM25PL | DBM25PS | DBM25PA | DBM25PG | DBM25PW |
| DC | 37 | DCM37PD | DCM37PL | DCM37PS | DCM37PA | DCM37PG | DCM37PW |
| DD | 50 | DDM50PD | DDM50PL | DDM50PS | DDM50PA | DDM50PG | DDM50PW |

Reader's Resource

For contact cavity arrangements, see page 224.
For P.C. hole patterns, see page 272.
For panel cutouts, see page 221.

| | | Commercial Part Numbers | | | | | |
|------------|--------|-------------------------|------------------|------------------|--------------------|------------------|------------------|
| | | Ø Y 0,76 (.030) | | | Ø Y 1,02 (.040) | | |
| Shell Size | Layout | X 3,23 (.127) | X 4,01 (.158) | X 4,65 (.183) | X 3,23 (.127) | X 4,01 (.158) | X 4,65 (.183) |
| DE | 9 | DEM9PD | DEM9PL | DEM9PS | DEM9PA | DEM9PG | DEM9PW |
| DA | 15 | DAM15PD | DAM15PL | DAM15PS | DAM15PA | DAM15PG | DAM15PW |
| DB | 25 | DBM25PD | DBM25PL | DBM25PS | DBM25PA | DBM25PG | DBM25PW |
| DC | 37 | DCM37PD | DCM37PL | DCM37PS | DCM37PA | DCM37PG | DCM37PW |
| DD | 50 | DDM50PD | DDM50PL | DDM50PS | DDM50PA | DDM50PG | DDM50PW |



Dimensions

| Shell Size | A ±0,38 (.015) | B ±0,13 (.005) | C ±0,13 (.005) | D ±0,13 (.005) | E ±0,38 (.015) | F ±0,25 (.010) | W ±0,368 (.0145) | W ±0,41 (.016) | L ±0,25 (.010) | M ±0,25 (.010) | N ±0,13 (.005) |
|------------|-------------------|-------------------|-------------------|-------------------|-------------------|-------------------|---------------------|-------------------|-------------------|-------------------|-------------------|
| DE | 30,81 (1.213) | 16,92 (.666) | 24,99 (.984) | 8,36 (.329) | 12,55 (.494) | 10,72 (.422) | 6,693 (.2635) | — | 0,76 (.030) | 12,30 (.484) | 8,64 (.340) |
| DA | 39,14 (1.541) | 25,25 (.994) | 33,32 (1.312) | 8,36 (.329) | 12,55 (.494) | 10,72 (.422) | 6,693 (.2635) | — | 0,76 (.030) | 12,30 (.484) | 8,64 (.340) |
| DB | 53,04 (2.088) | 38,96 (1.534) | 47,04 (1.852) | 8,36 (.329) | 12,55 (.494) | 10,82 (.426) | — | 6,84 (.269) | 0,99 (.039) | 12,30 (.484) | 8,64 (.340) |
| DC | 69,32 (2.729) | 55,42 (2.182) | 63,50 (2.500) | 8,36 (.329) | 12,55 (.494) | 10,82 (.426) | — | 6,84 (.269) | 0,99 (.039) | 12,30 (.484) | 8,64 (.340) |
| DD | 66,93 (2.635) | 52,81 (2.079) | 61,11 (2.406) | 11,07 (.436) | 15,37 (.605) | 10,82 (.426) | — | 6,84 (.269) | 0,99 (.039) | 15,09 (.594) | 10,04 (.395) |

90° PC Tail with Plastic Bracket

Receptacle



Part Numbers

| | | Military Part Numbers | | | | | |
|------------|--------|-----------------------|------------------|------------------|--------------------|------------------|------------------|
| | | Ø Y 0,76 (.030) | | | Ø Y 1,02 (.040) | | |
| Shell Size | Layout | X 3,23 (.127) | X 4,01 (.158) | X 4,65 (.183) | X 3,23 (.127) | X 4,01 (.158) | X 4,65 (.183) |
| DE | 9 | DEMM9SD | DEMM9SL | DEMM9SS | DEMM9SA | DEMM9SG | DEMM9SW |
| DA | 15 | DAMM15SD | DAMM15SL | DAMM15SS | DAMM15SA | DAMM15SG | DAMM15SW |
| DB | 25 | DBMM25SD | DBMM25SL | DBMM25SS | DBMM25SA | DBMM25SG | DBMM25SW |
| DC | 37 | DCMM37SD | DCMM37SL | DCMM37SS | DCMM37SA | DCMM37SG | DCMM37SW |
| DD | 50 | DDMM50SD | DDMM50SL | DDMM50SS | DDMM50SA | DDMM50SG | DDMM50SW |

Reader's Resource

For contact cavity arrangements, see page 224.
For P.C. hole patterns, see page 272.
For panel cutouts, see page 221.

| | | Commercial Part Numbers | | | | | |
|------------|--------|-------------------------|------------------|------------------|--------------------|------------------|------------------|
| | | Ø Y 0,76 (.030) | | | Ø Y 1,02 (.040) | | |
| Shell Size | Layout | X 3,23 (.127) | X 4,01 (.158) | X 4,65 (.183) | X 3,23 (.127) | X 4,01 (.158) | X 4,65 (.183) |
| DE | 9 | DEM9SD | DEM9SL | DEM9SS | DEM9SA | DEM9SG | DEM9SW |
| DA | 15 | DAM15SD | DAM15SL | DAM15SS | DAM15SA | DAM15SG | DAM15SW |
| DB | 25 | DBM25SD | DBM25SL | DBM25SS | DBM25SA | DBM25SG | DBM25SW |
| DC | 37 | DCM37SD | DCM37SL | DCM37SS | DCM37SA | DCM37SG | DCM37SW |
| DD | 50 | DDM50SD | DDM50SL | DDM50SS | DDM50SA | DDM50SG | DDM50SW |



DD Configuration



Dimensions

| Shell Size | A ±0,38 (.015) | B ±0,13 (.005) | C ±0,13 (.005) | D ±0,13 (.005) | E ±0,38 (.015) | F ±0,25 (.010) | W ±0,38 (.015) | L ±0,25 (.010) | M ±0,25 (.010) | N ±0,13 (.005) |
|------------|-------------------|-------------------|-------------------|-------------------|-------------------|-------------------|-------------------|-------------------|-------------------|-------------------|
| DE | 30,81 (1.213) | 16,33 (.643) | 24,99 (.984) | 7,90 (.311) | 12,55 (.494) | 10,90 (.429) | 6,94 (.273) | 0,76 (.030) | 12,30 (.484) | 8,64 (.340) |
| DA | 39,14 (1.541) | 24,66 (.971) | 33,32 (1.312) | 7,90 (.311) | 12,55 (.494) | 10,90 (.429) | 6,94 (.273) | 0,76 (.030) | 12,30 (.484) | 8,64 (.340) |
| DB | 53,04 (2.088) | 38,38 (1.511) | 47,04 (1.852) | 7,90 (.311) | 12,55 (.494) | 10,90 (.429) | 6,94 (.273) | 0,76 (.030) | 12,30 (.484) | 8,64 (.340) |
| DC | 69,32 (2.729) | 54,84 (2.159) | 63,50 (2.500) | 7,90 (.311) | 12,55 (.494) | 10,90 (.429) | 6,94 (.273) | 0,76 (.030) | 12,30 (.484) | 8,64 (.340) |
| DD | 66,93 (2.635) | 52,42 (2.064) | 61,11 (2.406) | 10,74 (.423) | 15,37 (.605) | 10,90 (.429) | 6,94 (.273) | 0,76 (.030) | 15,09 (.594) | 10,04 (.395) |

90° PC Tail

Plug



Reader's Resource

For contact cavity arrangements, see page 224.
 For P.C. hole patterns, see page 272.
 For panel cutouts, see page 221.
 For hardware views (Standard), see page 226.

Part Numbers

| | | Military Part Numbers | | | | | |
|------------|--------|-----------------------|------------------|------------------|--------------------|------------------|--|
| | | Ø Y 0,76 (.030) | | | Ø Y 1,02 (.040) | | |
| Shell Size | Layout | X 3,23 (.127) | X 4,01 (.158) | X 4,65 (.183) | X 3,23 (.127) | X 4,01 (.158) | |
| DE | 9 | DEMM9PF | DEMM9PP | DEMM9PR | DEMM9PC | DEMM9PK | |
| DA | 15 | DAMM15PF | DAMM15PP | DAMM15PR | DAMM15PC | DAMM15PK | |
| DB | 25 | DBMM25PF | DBMM25PP | DBMM25PR | DBMM25PC | DBMM25PK | |
| DC | 37 | DCMM37PF | DCMM37PP | DCMM37PR | DCMM37PC | DCMM37PK | |
| DD | 50 | DDMM50PF | DDMM50PP | DDMM50PR | DDMM50PC | DDMM50PK | |

| | | Commercial Part Numbers | | | | | |
|------------|--------|-------------------------|------------------|------------------|--------------------|------------------|--|
| | | Ø Y 0,76 (.030) | | | Ø Y 1,02 (.040) | | |
| Shell Size | Layout | X 3,23 (.127) | X 4,01 (.158) | X 4,65 (.183) | X 3,23 (.127) | X 4,01 (.158) | |
| DE | 9 | DEM9PF | DEM9PP | DEM9PR | DEM9PC | DEM9PK | |
| DA | 15 | DAM15PF | DAM15PP | DAM15PR | DAM15PC | DAM15PK | |
| DB | 25 | DBM25PF | DBM25PP | DBM25PR | DBM25PC | DBM25PK | |
| DC | 37 | DCM37PF | DCM37PP | DCM37PR | DCM37PC | DCM37PK | |
| DD | 50 | DDM50PF | DDM50PP | DDM50PR | DDM50PC | DDM50PK | |



Dimensions

| Shell Size | A ±0,38 (.015) | B ±0,13 (.005) | C ±0,13 (.005) | D ±0,13 (.005) | E ±0,38 (.015) | F ±0,25 (.010) | W ±0,368 (.0145) | W ±0,41 (.016) | K ±0,317 (.0125) | K ±0,25 (.010) | L ±0,25 (.010) |
|------------|-------------------|-------------------|-------------------|-------------------|-------------------|-------------------|---------------------|-------------------|---------------------|-------------------|-------------------|
| DE | 30,81 (1.213) | 16,92 (.666) | 24,99 (.984) | 8,36 (.329) | 12,55 (.494) | 10,72 (.422) | 6,693 (.2635) | — | 1,206 (.0475) | — | 0,76 (.030) |
| DA | 39,14 (1.541) | 25,25 (.994) | 33,32 (1.312) | 8,36 (.329) | 12,55 (.494) | 10,72 (.422) | 6,693 (.2635) | — | 1,206 (.0475) | — | 0,76 (.030) |
| DB | 53,04 (2.088) | 38,96 (1.534) | 47,04 (1.852) | 8,36 (.329) | 12,55 (.494) | 10,82 (.426) | — | 6,84 (.269) | — | 1,52 (.060) | 0,99 (.039) |
| DC | 69,32 (2.729) | 55,42 (2.182) | 63,50 (2.500) | 8,36 (.329) | 12,55 (.494) | 10,82 (.426) | — | 6,84 (.269) | — | 1,52 (.060) | 0,99 (.039) |
| DD | 66,93 (2.635) | 52,81 (2.079) | 61,11 (2.406) | 11,07 (.436) | 15,37 (.605) | 10,82 (.426) | — | 6,84 (.269) | — | 1,52 (.060) | 0,99 (.039) |

90° PC Tail

Receptacle



Reader's Resource

For contact cavity arrangements, see page 224.

For P.C. hole patterns, see page 272.

For panel cutouts, see page 221.

For hardware view (Standard), see page 226.

Part Numbers

| | | Military Part Numbers | | | | | |
|------------|--------|-----------------------|------------------|------------------|--------------------|------------------|--|
| | | Ø Y 0,76 (.030) | | | Ø Y 1,02 (.040) | | |
| Shell Size | Layout | X 3,23 (.127) | X 4,01 (.158) | X 4,65 (.183) | X 3,23 (.127) | X 4,01 (.158) | |
| DE | 9 | DEMM9SF | DEMM9SP | DEMM9SR | DEMM9SC | DEMM9SK | |
| DA | 15 | DAMM15SF | DAMM15SP | DAMM15SR | DAMM15SC | DAMM15SK | |
| DB | 25 | DBMM25SF | DBMM25SP | DBMM25SR | DBMM25SC | DBMM25SK | |
| DC | 37 | DCMM37SF | DCMM37SP | DCMM37SR | DCMM37SC | DCMM37SK | |
| DD | 50 | DDMM50SF | DDMM50SP | DDMM50SR | DDMM50SC | DDMM50SK | |

| | | Commercial Part Numbers | | | | | |
|------------|--------|-------------------------|------------------|------------------|--------------------|------------------|--|
| | | Ø Y 0,76 (.030) | | | Ø Y 1,02 (.040) | | |
| Shell Size | Layout | X 3,23 (.127) | X 4,01 (.158) | X 4,65 (.183) | X 3,23 (.127) | X 4,01 (.158) | |
| DE | 9 | DEM9SF | DEM9SP | DEM9SR | DEM9SC | DEM9SK | |
| DA | 15 | DAM15SF | DAM15SP | DAM15SR | DAM15SC | DAM15SK | |
| DB | 25 | DBM25SF | DBM25SP | DBM25SR | DBM25SC | DBM25SK | |
| DC | 37 | DCM37SF | DCM37SP | DCM37SR | DCM37SC | DCM37SK | |
| DD | 50 | DDM50SF | DDM50SP | DDM50SR | DDM50SC | DDM50SK | |

Engaging Face



DD Configuration



Dimensions

| Shell Size | A ±0,38 (.015) | B ±0,13 (.005) | C ±0,13 (.005) | D ±0,13 (.005) | E ±0,38 (.015) | F ±0,25 (.010) | W ±0,38 (.015) | K ±0,318 (.0125) | L ±0,25 (.010) |
|------------|-------------------|-------------------|-------------------|-------------------|-------------------|-------------------|-------------------|---------------------|-------------------|
| DE | 30,81 (1.213) | 16,33 (.643) | 24,99 (.984) | 7,90 (.311) | 12,55 (.494) | 10,90 (.429) | 6,94 (.273) | 1,206 (.0475) | 0,76 (.030) |
| DA | 39,14 (1.541) | 24,66 (.971) | 33,32 (1.312) | 7,90 (.311) | 12,55 (.494) | 10,90 (.429) | 6,94 (.273) | 1,206 (.0475) | 0,76 (.030) |
| DB | 53,04 (2.088) | 38,38 (1.511) | 47,04 (1.852) | 7,90 (.311) | 12,55 (.494) | 10,90 (.429) | 6,94 (.273) | 1,206 (.0475) | 0,76 (.030) |
| DC | 69,32 (2.729) | 54,84 (2.159) | 63,50 (2.500) | 7,90 (.311) | 12,55 (.494) | 10,90 (.429) | 6,94 (.273) | 1,206 (.0475) | 0,76 (.030) |
| DD | 66,93 (2.635) | 52,42 (2.064) | 61,11 (2.406) | 10,74 (.423) | 15,37 (.605) | 10,90 (.429) | 6,94 (.273) | 1,206 (.0475) | 0,76 (.030) |

Straight PC Tail

Plug



Part Numbers

| | | Military Part Numbers | | | | | |
|------------|--------|-----------------------|------------------|------------------|--------------------|------------------|------------------|
| | | Ø Y 0,76 (.030) | | | Ø Y 1,02 (.040) | | |
| Shell Size | Layout | X 3,23 (.127) | X 4,01 (.158) | X 4,65 (.183) | X 3,23 (.127) | X 4,01 (.158) | X 4,65 (.183) |
| DE | 9 | DEMM9PE* | DEMM9PM* | DEMM9PZ* | DEMM9PB | DEMM9PH | DEMM9PX* |
| DA | 15 | DAMM15PE* | DAMM15PM* | DAMM15PZ* | DAMM15PB | DAMM15PH | DAMM15PX* |
| DB | 25 | DBMM25PE* | DBMM25PM* | DBMM25PZ* | DBMM25PB | DBMM25PH | DBMM25PX* |
| DC | 37 | DCMM37PE* | DCMM37PM* | DCMM37PZ* | DCMM37PB | DCMM37PH | DCMM37PX* |
| DD | 50 | DDMM50PE* | DDMM50PM* | DDMM50PZ* | DDMM50PB | DDMM50PH | DDMM50PX* |

Note: Spacers (shipped loose) provided only on parts marked *

Reader's Resource

- For contact cavity arrangements, see page 224.
- For P.C. hole patterns, see page 274.
- For panel cutouts, see page 221.
- For hardware views (Standard), see page 226.

| | | Commercial Part Numbers | | | | | |
|------------|--------|-------------------------|------------------|------------------|--------------------|------------------|------------------|
| | | Ø Y 0,76 (.030) | | | Ø Y 1,02 (.040) | | |
| Shell Size | Layout | X 3,23 (.127) | X 4,01 (.158) | X 4,65 (.183) | X 3,23 (.127) | X 4,01 (.158) | X 4,65 (.183) |
| DE | 9 | DEM9PE | DEM9PM | DEM9PZ | DEM9PB | DEM9PH | DEM9PX |
| DA | 15 | DAM15PE | DAM15PM | DAM15PZ | DAM15PB | DAM15PH | DAM15PX |
| DB | 25 | DBM25PE | DBM25PM | DBM25PZ | DBM25PB | DBM25PH | DBM25PX |
| DC | 37 | DCM37PE | DCM37PM | DCM37PZ | DCM37PB | DCM37PH | DCM37PX |
| DD | 50 | DDM50PE | DDM50PM | DDM50PZ | DDM50PB | DDM50PH | DDM50PX |



Dimensions

| Shell Size | A ±0,38 (.015) | B ±0,13 (.005) | C ±0,13 (.005) | D ±0,13 (.005) | E ±0,38 (.015) | F ±0,25 (.010) | W ±0,368 (.0145) | W ±0,41 (.016) | K ±0,317 (.0125) | K ±0,25 (.010) | L ±0,25 (.010) |
|------------|-------------------|-------------------|-------------------|-------------------|-------------------|-------------------|---------------------|-------------------|---------------------|-------------------|-------------------|
| DE | 30,81 (1.213) | 16,92 (.666) | 24,99 (.984) | 8,36 (.329) | 12,55 (.494) | 10,72 (.422) | 6,693 (.2635) | — | 1,206 (.0475) | — | 0,76 (.030) |
| DA | 39,14 (1.541) | 25,25 (.994) | 33,32 (1.312) | 8,36 (.329) | 12,55 (.494) | 10,72 (.422) | 6,693 (.2635) | — | 1,206 (.0475) | — | 0,76 (.030) |
| DB | 53,04 (2.088) | 38,96 (1.534) | 47,04 (1.852) | 8,36 (.329) | 12,55 (.494) | 10,82 (.426) | — | 6,84 (.269) | — | 1,52 (.060) | 0,99 (.039) |
| DC | 69,32 (2.729) | 55,42 (2.182) | 63,50 (2.500) | 8,36 (.329) | 12,55 (.494) | 10,82 (.426) | — | 6,84 (.269) | — | 1,52 (.060) | 0,99 (.039) |
| DD | 66,93 (2.635) | 52,81 (2.079) | 61,11 (2.406) | 11,07 (.436) | 15,37 (.605) | 10,82 (.426) | — | 6,84 (.269) | — | 1,52 (.060) | 0,99 (.039) |

Straight PC Tail

Receptacle



Part Numbers

| | | Military Part Numbers | | | | | |
|------------|--------|-----------------------|------------------|------------------|--------------------|------------------|------------------|
| | | Ø Y 0,76 (.030) | | | Ø Y 1,02 (.040) | | |
| Shell Size | Layout | X 3,23 (.127) | X 4,01 (.158) | X 4,65 (.183) | X 3,23 (.127) | X 4,01 (.158) | X 4,65 (.183) |
| DE | 9 | DEM9SE* | DEM9SM* | DEM9SZ* | DEM9SB | DEM9SH | DEM9SX* |
| DA | 15 | DAM15SE* | DAM15SM* | DAM15SZ* | DAM15SB | DAM15SH | DAM15SX* |
| DB | 25 | DBM25SE* | DBM25SM* | DBM25SZ* | DBM25SB | DBM25SH | DBM25SX* |
| DC | 37 | DCM37SE* | DCM37SM* | DCM37SZ* | DCM37SB | DCM37SH | DCM37SX* |
| DD | 50 | DDM50SE* | DDM50SM* | DDM50SZ* | DDM50SB | DDM50SH | DDM50SX* |

Note: Spacers (shipped loose) provided only on parts marked *

Reader's Resource

For contact cavity arrangements, see page 224.

For P.C. hole patterns, see page 274.

For panel cutouts, see page 221.

For hardware views (Standard), see page 226.

| | | Commercial Part Numbers | | | | | |
|------------|--------|-------------------------|------------------|------------------|--------------------|------------------|------------------|
| | | Ø Y 0,76 (.030) | | | Ø Y 1,02 (.040) | | |
| Shell Size | Layout | X 3,23 (.127) | X 4,01 (.158) | X 4,65 (.183) | X 3,23 (.127) | X 4,01 (.158) | X 4,65 (.183) |
| DE | 9 | DEM9SE | DEM9SM | DEM9SZ | DEM9SB | DEM9SH | DEM9SX |
| DA | 15 | DAM15SE | DAM15SM | DAM15SZ | DAM15SB | DAM15SH | DAM15SX |
| DB | 25 | DBM25SE | DBM25SM | DBM25SZ | DBM25SB | DBM25SH | DBM25SX |
| DC | 37 | DCM37SE | DCM37SM | DCM37SZ | DCM37SB | DCM37SH | DCM37SX |
| DD | 50 | DDM50SE | DDM50SM | DDM50SZ | DDM50SB | DDM50SH | DDM50SX |



Dimensions

| Shell Size | A ±0,38 (.015) | B ±0,13 (.005) | C ±0,13 (.005) | D ±0,13 (.005) | E ±0,38 (.015) | F ±0,25 (.010) | W ±0,38 (.015) | K ±0,318 (.0125) | L ±0,25 (.010) |
|------------|-------------------|-------------------|-------------------|-------------------|-------------------|-------------------|-------------------|---------------------|-------------------|
| DE | 30,81 (1.213) | 16,33 (.643) | 24,99 (.984) | 7,90 (.311) | 12,55 (.494) | 10,90 (.429) | 6,94 (.273) | 1,206 (.0475) | 0,76 (.030) |
| DA | 39,14 (1.541) | 24,66 (.971) | 33,32 (1.312) | 7,90 (.311) | 12,55 (.494) | 10,90 (.429) | 6,94 (.273) | 1,206 (.0475) | 0,76 (.030) |
| DB | 53,04 (2.088) | 38,38 (1.511) | 47,04 (1.852) | 7,90 (.311) | 12,55 (.494) | 10,90 (.429) | 6,94 (.273) | 1,206 (.0475) | 0,76 (.030) |
| DC | 69,32 (2.729) | 54,84 (2.159) | 63,50 (2.500) | 7,90 (.311) | 12,55 (.494) | 10,90 (.429) | 6,94 (.273) | 1,206 (.0475) | 0,76 (.030) |
| DD | 66,93 (2.635) | 52,42 (2.064) | 61,11 (2.406) | 10,74 (.423) | 15,37 (.605) | 10,90 (.429) | 6,94 (.273) | 1,206 (.0475) | 0,76 (.030) |

Wrap Post Connector

Plug



Part Numbers

| Shell Size | Layout | Military Part Numbers | |
|------------|--------|-----------------------|--------------|
| DE | 9 | DEMM9PF179 | DEMM9PF179A |
| DA | 15 | DAMM15PF179 | DAMM15PF179A |
| DB | 25 | DBMM25PF179 | DBMM25PF179A |
| DC | 37 | DCMM37PF179 | DCMM37PF179A |
| DD | 50 | DDMM50PF179 | DDMM50PF179A |

| Shell Size | Layout | Commercial Part Numbers | |
|------------|--------|-------------------------|-------------|
| DE | 9 | DEM9PF179 | DEM9PF179A |
| DA | 15 | DAM15PF179 | DAM15PF179A |
| DB | 25 | DBM25PF179 | DBM25PF179A |
| DC | 37 | DCM37PF179 | DCM37PF179A |
| DD | 50 | DDM50PF179 | DDM50PF179A |

Reader's Resource

- For contact cavity arrangements, see page 224.
- For P.C. hole patterns, see page 274.
- For panel cutouts, see page 221.
- For hardware views (Standard), see page 226.

| Modification Code | Number of Wraps | X ±0,51 (.020) |
|-------------------|-----------------|-------------------|
| F179 | 2 | 9,60 (.378) |
| F179A | 3 | 12,90 (.508) |



DD Configuration



Dimensions

| Shell Size | A ±0,38 (.015) | B ±0,13 (.005) | C ±0,13 (.005) | D ±0,13 (.005) | E ±0,38 (.015) | F ±0,25 (.010) | W ±0,368 (.0145) | W ±0,41 (.016) | K ±0,317 (.0125) | K ±0,25 (.010) | L ±0,25 (.010) |
|------------|-------------------|-------------------|-------------------|-------------------|-------------------|-------------------|---------------------|-------------------|---------------------|-------------------|-------------------|
| DE | 30,81 (1.213) | 16,92 (.666) | 24,99 (.984) | 8,36 (.329) | 12,55 (.494) | 10,72 (.422) | 6,693 (.2635) | — | 1,206 (.0475) | — | 0,76 (.030) |
| DA | 39,14 (1.541) | 25,25 (.994) | 33,32 (1.312) | 8,36 (.329) | 12,55 (.494) | 10,72 (.422) | 6,693 (.2635) | — | 1,206 (.0475) | — | 0,76 (.030) |
| DB | 53,04 (2.088) | 38,96 (1.534) | 47,04 (1.852) | 8,36 (.329) | 12,55 (.494) | 10,82 (.426) | — | 6,84 (.269) | — | 1,52 (.060) | 0,99 (.039) |
| DC | 69,32 (2.729) | 55,42 (2.182) | 63,50 (2.500) | 8,36 (.329) | 12,55 (.494) | 10,82 (.426) | — | 6,84 (.269) | — | 1,52 (.060) | 0,99 (.039) |
| DD | 66,93 (2.635) | 52,81 (2.079) | 61,11 (2.406) | 11,07 (.436) | 15,37 (.605) | 10,82 (.426) | — | 6,84 (.269) | — | 1,52 (.060) | 0,99 (.039) |

Wrap Post Connector

Receptacle



Reader's Resource

For contact cavity arrangements, see page 224.
 For P.C. hole patterns, see page 274.
 For panel cutouts, see page 221.
 For hardware views (Standard), see page 226.

Part Numbers

| Shell Size | Layout | Military Part Numbers | |
|------------|--------|-----------------------|--------------|
| DE | 9 | DEMM9SF179 | DEMM9SF179A |
| DA | 15 | DAMM15SF179 | DAMM15SF179A |
| DB | 25 | DBMM25SF179 | DBMM25SF179A |
| DC | 37 | DCMM37SF179 | DCMM37SF179A |
| DD | 50 | DDMM50SF179 | DDMM50SF179A |

| Shell Size | Layout | Commercial Part Numbers | |
|------------|--------|-------------------------|-------------|
| DE | 9 | DEM9SF179 | DEM9SF179A |
| DA | 15 | DAM15SF179 | DAM15SF179A |
| DB | 25 | DBM25SF179 | DBM25SF179A |
| DC | 37 | DCM37SF179 | DCM37SF179A |
| DD | 50 | DDM50SF179 | DDM50SF179A |

| Modification Code | Number of Wraps | X ±0,51 (.020) |
|-------------------|-----------------|-------------------|
| F179 | 2 | 9,60 (.378) |
| F179A | 3 | 12,90 (.508) |



DD Configuration



Dimensions

| Shell Size | A ±0,38 (.015) | B ±0,13 (.005) | C ±0,13 (.005) | D ±0,13 (.005) | E ±0,38 (.015) | F ±0,25 (.010) | W ±0,38 (.015) | K ±0,318 (.0125) | L ±0,25 (.010) |
|------------|-------------------|-------------------|-------------------|-------------------|-------------------|-------------------|-------------------|---------------------|-------------------|
| DE | 30,81 (1.213) | 16,33 (.643) | 24,99 (.984) | 7,90 (.311) | 12,55 (.494) | 10,90 (.429) | 6,94 (.273) | 1,206 (.0475) | 0,76 (.030) |
| DA | 39,14 (1.541) | 24,66 (.971) | 33,32 (1.312) | 7,90 (.311) | 12,55 (.494) | 10,90 (.429) | 6,94 (.273) | 1,206 (.0475) | 0,76 (.030) |
| DB | 53,04 (2.088) | 38,38 (1.511) | 47,04 (1.852) | 7,90 (.311) | 12,55 (.494) | 10,90 (.429) | 6,94 (.273) | 1,206 (.0475) | 0,76 (.030) |
| DC | 69,32 (2.729) | 54,84 (2.159) | 63,50 (2.500) | 7,90 (.311) | 12,55 (.494) | 10,90 (.429) | 6,94 (.273) | 1,206 (.0475) | 0,76 (.030) |
| DD | 66,93 (2.635) | 52,42 (2.064) | 61,11 (2.406) | 10,74 (.423) | 15,37 (.605) | 10,90 (.429) | 6,94 (.273) | 1,206 (.0475) | 0,76 (.030) |

Solder Cup Connector

Plug



Reader's Resource

For contact cavity arrangements, see page 224.

For panel cutouts, see page 221.

For hardware views (Standard), see page 226.

Part Numbers

| Shell Size | Layout | Military Part Numbers | | |
|------------|--------|-----------------------|------------------|----------------------|
| | | Through Hole | Dual Float Mount | Clinch Nut #4-40 UNC |
| DE | 9 | DEMM9P | DEMMY9P | DEMME9P |
| DA | 15 | DAMM15P | DAMMY15P | DAMME15P |
| DB | 25 | DBMM25P | DBMMY25P | DBMME25P |
| DC | 37 | DCMM37P | DCMMY37P | DCMME37P |
| DD | 50 | DDMM50P | DDMMY50P | DDMME50P |

| Shell Size | Layout | Commercial Part Numbers | | |
|------------|--------|-------------------------|------------------|----------------------|
| | | Through Hole | Dual Float Mount | Clinch Nut #4-40 UNC |
| DE | 9 | DEM9P | DEMY9P | DEME9P |
| DA | 15 | DAM15P | DAMY15P | DAME15P |
| DB | 25 | DBM25P | DBMY25P | DBME25P |
| DC | 37 | DCM37P | DCMY37P | DCME37P |
| DD | 50 | DDM50P | DDMY50P | DDME50P |



Dimensions

| Shell Size | A | B | C | D | E | F | W | W | K | K | L |
|------------|---------------|---------------|---------------|--------------|--------------|--------------|----------------|--------------|----------------|--------------|--------------|
| | ±0,38 (.015) | ±0,13 (.005) | ±0,13 (.005) | ±0,13 (.005) | ±0,38 (.015) | ±0,25 (.010) | ±0,368 (.0145) | ±0,41 (.016) | ±0,317 (.0125) | ±0,25 (.010) | ±0,25 (.010) |
| DE | 30,81 (1.213) | 16,92 (.666) | 24,99 (.984) | 8,36 (.329) | 12,55 (.494) | 10,72 (.422) | 6,693 (.2635) | — | 1,206 (.0475) | — | 0,76 (.030) |
| DA | 39,14 (1.541) | 25,25 (.994) | 33,32 (1.312) | 8,36 (.329) | 12,55 (.494) | 10,72 (.422) | 6,693 (.2635) | — | 1,206 (.0475) | — | 0,76 (.030) |
| DB | 53,04 (2.088) | 38,96 (1.534) | 47,04 (1.852) | 8,36 (.329) | 12,55 (.494) | 10,82 (.426) | — | 6,84 (.269) | — | 1,52 (.060) | 0,99 (.039) |
| DC | 69,32 (2.729) | 55,42 (2.182) | 63,50 (2.500) | 8,36 (.329) | 12,55 (.494) | 10,82 (.426) | — | 6,84 (.269) | — | 1,52 (.060) | 0,99 (.039) |
| DD | 66,93 (2.635) | 52,81 (2.079) | 61,11 (2.406) | 11,07 (.436) | 15,37 (.605) | 10,82 (.426) | — | 6,84 (.269) | — | 1,52 (.060) | 0,99 (.039) |

Solder Cup Connector

Receptacle



Reader's Resource

For contact cavity arrangements, see page 224.
 For panel cutouts, see page 221.
 For hardware views (Standard), see page 226.

Part Numbers

| Shell Size | Layout | Military Part Numbers | | |
|------------|--------|-----------------------|------------------|----------------------|
| | | Through Hole | Dual Float Mount | Clinch Nut #4-40 UNC |
| DE | 9 | DEMM9S | DEMMY9S | DEMME9S |
| DA | 15 | DAMM15S | DAMMY15S | DAMME15S |
| DB | 25 | DBMM25S | DBMMY25S | DBMME25S |
| DC | 37 | DCMM37S | DCMMY37S | DCMME37S |
| DD | 50 | DDMM50S | DDMMY50S | DDMME50S |

| Shell Size | Layout | Commercial Part Numbers | | |
|------------|--------|-------------------------|------------------|----------------------|
| | | Through Hole | Dual Float Mount | Clinch Nut #4-40 UNC |
| DE | 9 | DEM9S | DEMY9S | DEME9S |
| DA | 15 | DAM15S | DAMY15S | DAME15S |
| DB | 25 | DBM25S | DBMY25S | DBME25S |
| DC | 37 | DCM37S | DCMY37S | DCME37S |
| DD | 50 | DDM50S | DDMY50S | DDME50S |



DD Configuration



Dimensions

| Shell Size | A ±0,38 (.015) | B ±0,13 (.005) | C ±0,13 (.005) | D ±0,13 (.005) | E ±0,38 (.015) | F ±0,25 (.010) | W ±0,38 (.015) | K ±0,318 (.0125) | L ±0,25 (.010) |
|------------|-------------------|-------------------|-------------------|-------------------|-------------------|-------------------|-------------------|---------------------|-------------------|
| DE | 30,81 (1.213) | 16,33 (.643) | 24,99 (.984) | 7,90 (.311) | 12,55 (.494) | 10,90 (.429) | 6,94 (.273) | 1,206 (.0475) | 0,76 (.030) |
| DA | 39,14 (1.541) | 24,66 (.971) | 33,32 (1.312) | 7,90 (.311) | 12,55 (.494) | 10,90 (.429) | 6,94 (.273) | 1,206 (.0475) | 0,76 (.030) |
| DB | 53,04 (2.088) | 38,38 (1.511) | 47,04 (1.852) | 7,90 (.311) | 12,55 (.494) | 10,90 (.429) | 6,94 (.273) | 1,206 (.0475) | 0,76 (.030) |
| DC | 69,32 (2.729) | 54,84 (2.159) | 63,50 (2.500) | 7,90 (.311) | 12,55 (.494) | 10,90 (.429) | 6,94 (.273) | 1,206 (.0475) | 0,76 (.030) |
| DD | 66,93 (2.635) | 52,42 (2.064) | 61,11 (2.406) | 10,74 (.423) | 15,37 (.605) | 10,90 (.429) | 6,94 (.273) | 1,206 (.0475) | 0,76 (.030) |

24308-Style Cross Reference

| Military Part Number | ITT Cannon Part Number | Military Part Number | ITT Cannon Part Number | Military Part Number | ITT Cannon Part Number |
|----------------------|------------------------|----------------------|------------------------|----------------------|------------------------|
| M24308/1-1 | DEMM9S | M24308/3-3 | DBMM25P | M24308/6-261 | DBMAMF25SNM |
| M24308/1-2 | DAMM15S | M24308/3-4 | DCMM37P | M24308/6-262 | DCMAMF37SNM |
| M24308/1-3 | DBMM25S | M24308/3-5 | DDMM50P | M24308/6-263 | DDMAMF50SNM |
| M24308/1-4 | DCMM37S | M24308/3-12 | DEMMF9P | M24308/6-270 | DEMAMFT9SNM |
| M24308/1-5 | DDMM50S | M24308/3-13 | DAMMF15P | M24308/6-271 | DAMAMFT15SNM |
| M24308/1-12 | DEMMF9S | M24308/3-14 | DBMMF25P | M24308/6-272 | DBMAMFT25SNM |
| M24308/1-13 | DAMMF15S | M24308/3-15 | DCMMF37P | M24308/6-273 | DCMAMFT37SNM |
| M24308/1-14 | DBMMF25S | M24308/3-16 | DDMMF50P | M24308/6-274 | DDMAMF50SNM |
| M24308/1-15 | DCMMF37S | M24308/4-1 | DEMAM9P | M24308/6-281 | DEMAM9SNM-FO |
| M24308/1-16 | DDMMF50S | M24308/4-2 | DAMAM15P | M24308/6-282 | DAMAM15SNM-FO |
| M24308/1-23 | DEMMY9S | M24308/4-3 | DBMAM25P | M24308/6-283 | DBMAM25SNM-FO |
| M24308/1-24 | DAMMY15S | M24308/4-4 | DCMAM37P | M24308/6-284 | DCMAM37SNM-FO |
| M24308/1-25 | DBMMY25S | M24308/4-5 | DDMAM50P | M24308/6-285 | DDMAM50SNM-FO |
| M24308/1-26 | DCMMY37S | M24308/4-6 | DEMAMT9P | M24308/6-324 | DEMAMF9SNM-FO |
| M24308/1-27 | DDMMY50S | M24308/4-7 | DAMAMT15P | M24308/6-325 | DAMAMF15SNM-FO |
| M24308/2-1 | DEMAM9S | M24308/4-8 | DBMAMT25P | M24308/6-326 | DBMAMF25SNM-FO |
| M24308/2-2 | DAMAM15S | M24308/4-9 | DCMAMT37P | M24308/6-327 | DCMAMF37SNM-FO |
| M24308/2-3 | DBMAM25S | M24308/4-10 | DDMAMT50P | M24308/6-328 | DDMAMF50SNM-FO |
| M24308/2-4 | DCMAM37S | M24308/4-259 | DEMAM9P-FO | M24308/6-453 | DEMAMY9SNM |
| M24308/2-5 | DDMAM50S | M24308/4-260 | DAMAM15P-FO | M24308/6-454 | DAMAMY15SNM |
| M24308/2-6 | DEMAMT9S | M24308/4-261 | DBMAMF25P-FO | M24308/6-455 | DBMAMY25SNM |
| M24308/2-7 | DAMAMT15S | M24308/4-262 | DCMAM37P-FO | M24308/6-456 | DCMAMY37SNM |
| M24308/2-8 | DBMAMT25S | M24308/4-263 | DDMAM50P-FO | M24308/6-457 | DDMAMY50SNM |
| M24308/2-9 | DCMAMT37S | M24308/4-302 | DEMAMF9P | M24308/6-464 | DDMEMYT9SNM |
| M24308/2-10 | DDMAMT50S | M24308/4-303 | DAMAMF15P | M24308/6-465 | DAMAMYT15SNM |
| M24308/2-23 | DEMAMF9S | M24308/4-304 | DBMAMF25P | M24308/6-466 | DBMAMYT25SNM |
| M24308/2-24 | DAMAMF15S | M24308/4-305 | DCMAMF37P | M24308/6-467 | DCMAMYT37SNM |
| M24308/2-25 | DBMAMF25S | M24308/4-306 | DDMAMF50P | M24308/6-468 | DDMAMYT50SNM |
| M24308/2-26 | DCMAMF37S | M24308/4-313 | DEMAMF9P | M24308/6-491 | DEMAMY9SNM-FO |
| M24308/2-27 | DDMAMF50S | M24308/4-314 | DAMAMF15P | M24308/6-492 | DAMAMY15SNM-FO |
| M24308/2-34 | DEMAMFT9S | M24308/4-315 | DBMAMFT25P | M24308/6-493 | DBMAMY25SNM-FO |
| M24308/2-35 | DAMAMFT15S | M24308/4-316 | DCMAMFT37P | M24308/6-494 | DCMAMY37SNM-FO |
| M24308/2-36 | DBMAMFT25S | M24308/4-317 | DDMAMFT50P | M24308/6-495 | DDMAMY50SNM-FO |
| M24308/2-37 | DCMAMFT37S | M24308/4-324 | DEMAMF9P-FO | M24308/7-1 | DEMMP9PNM |
| M24308/2-38 | DDMAMFT50S | M24308/4-325 | DAMAMF15P-FO | M24308/7-2 | DAMM15PNM |
| M24308/2-281 | DEMAM9S-FO | M24308/4-326 | DBMAMF25P-FO | M24308/7-3 | DBMM25PNM |
| M24308/2-282 | DAMAM15S-FO | M24308/4-327 | DCMAMF37P-FO | M24308/7-4 | DCMM37PNM |
| M24308/2-283 | DBMAM25S-FO | M24308/4-328 | DDMAMF50P-FO | M24308/7-5 | DDMM50PNM |
| M24308/2-284 | DCMAM37S-FO | M24308/5-1 | DEMM9SNM | M24308/7-12 | DEMMF9PNM |
| M24308/2-285 | DDMAM50S-FO | M24308/5-2 | DAMM15SNM | M24308/7-13 | DAMMF15PNM |
| M24308/2-292 | DEMAMF9S-FO | M24308/5-3 | DBMM25SNM | M24308/7-14 | DBMMF25PNM |
| M24308/2-293 | DAMAMF15S-FO | M24308/5-4 | DCMM37SNM | M24308/7-15 | DCMMF37PNM |
| M24308/2-294 | DBMAMF25S-FO | M24308/5-5 | DDMM50SNM | M24308/7-16 | DDMMF50PNM |
| M24308/2-295 | DCMAMF37S-FO | M24308/5-12 | DEMMF9SNM | M24308/8-1 | DEMAM9PNM |
| M24308/2-296 | DDMAMF50S-FO | M24308/5-13 | DAMMF15SNM | M24308/8-2 | DAMAM15PNM |
| M24308/2-335 | DBMAMR25S | M24308/5-14 | DBMMF25SNM | M24308/8-3 | DBMAM25PNM |
| M24308/2-336 | DCMAMR37S | M24308/5-15 | DCMMF37SNM | M24308/8-4 | DCMAM37PNM |
| M24308/2-341 | DAMAMR15S | M24308/5-16 | DDMMF50SNM | M24308/8-5 | DDMAM50PNM |
| M24308/2-342 | DEMAMY9S | M24308/5-23 | DDMMY9SNM | M24308/8-6 | DEMAMT9PNM |
| M24308/2-343 | DAMAMY15S | M24308/5-24 | DAMMY15SNM | M24308/8-7 | DAMAMT15PNM |
| M24308/2-344 | DBMAMY25S | M24308/5-25 | DBMMY25SNM | M24308/8-8 | DBMAMT25PNM |
| M24308/2-345 | DCMAMY37S | M24308/5-26 | DCMMY37SNM | M24308/8-9 | DCMAMT37PNM |
| M24308/2-346 | DDMAMY50S | M24308/5-27 | DDMMY50SNM | M24308/8-10 | DDMAMT50PNM |
| M24308/2-353 | DEMAMYT9S | M24308/6-1 | DEMAM9SNM | M24308/8-259 | DEMAM9PNM-FO |
| M24308/2-354 | DAMAMYT15S | M24308/6-2 | DAMAM15SNM | M24308/8-260 | DAMAM15PNM-FO |
| M24308/2-355 | DBMAMYT25S | M24308/6-3 | DBMAM25SNM | M24308/8-261 | DBMAM25PNM-FO |
| M24308/2-356 | DCMAMYT37S | M24308/6-4 | DCMAM37SNM | M24308/8-262 | DCMAM37PNM-FO |
| M24308/2-357 | DDMAMYT50S | M24308/6-5 | DDMAM50SNM | M24308/8-263 | DDMAM50PNM-FO |
| M24308/2-482 | DEMAMY9S-FO | M24308/6-6 | DEMAMT9SNM | M24308/8-302 | DEMAMF9PNM |
| M24308/2-483 | DEMAMY15S-FO | M24308/6-7 | DAMAMT15SNM | M24308/8-303 | DAMAMF15PNM |
| M24308/2-484 | DEMAMY25S-FO | M24308/6-8 | DBMAMT25SNM | M24308/8-304 | DBMAMF25PNM |
| M24308/2-485 | DCMAMY37S-FO | M24308/6-9 | DCMAMT37SNM | M24308/8-305 | DCMAMF37PNM |
| M24308/2-486 | DDMAMY50S-FO | M24308/6-10 | DDMAMT50SNM | M24308/8-306 | DDMAMF50PNM |
| M24308/3-1 | DEMM9P | M24308/6-259 | DEMAMF9SNM | M24308/8-313 | DEMAMF9PNM |
| M24308/3-2 | DAMM15P | M24308/6-260 | DAMAMF15SNM | M24308/8-314 | DAMAMF15PNM |

24308-Style Cross Reference

| Military Part Number | ITT Cannon Part Number | Military Part Number | ITT Cannon Part Number | Military Part Number | ITT Cannon Part Number |
|----------------------|------------------------|----------------------|------------------------|----------------------|------------------------|
| M24308/8-315 | DBMAMFT25PNM | M24308/23-21 | DBMM25SX | M24308/24-15 | DBMM25PH |
| M24308/8-316 | DCMAMFT37PNM | M24308/23-22 | DCMM37SX | M24308/24-16 | DCMM37PH |
| M24308/8-317 | DDMAMFT50PNM | M24308/23-23 | DDMM50SX | M24308/24-17 | DDMM50PH |
| M24308/8-324 | DEMAMF9PNM-FO | M24308/23-25 | DEMM9SD | M24308/24-19 | DEMM9PX |
| M24308/8-325 | DAMAMF15PNM-FO | M24308/23-26 | DAMM15SD | M24308/24-20 | DAMM15PX |
| M24308/8-326 | DBMAMF25PNM-FO | M24308/23-27 | DBMM25SD | M24308/24-21 | DBMM25PX |
| M24308/8-327 | DCMAMF37PNM-FO | M24308/23-28 | DCMM37SD | M24308/24-22 | DCMM37PX |
| M24308/8-328 | DDMAMF50PNM-FO | M24308/23-29 | DDMM50SD | M24308/24-23 | DDMM50PX |
| M24308/9-1 | DEH9P002 | M24308/23-31 | DEMM9SL | M24308/24-25 | DEMM9PD |
| M24308/9-2 | DAH15P002 | M24308/23-32 | DAMM15SL | M24308/24-26 | DAMM15PD |
| M24308/9-3 | DBH25P002 | M24308/23-33 | DBMM25SL | M24308/24-27 | DBMM25PD |
| M24308/9-4 | DCH37P002 | M24308/23-34 | DCMM37SL | M24308/24-28 | DCMM37PD |
| M24308/9-5 | DDH50P002 | M24308/23-35 | DDMM50SL | M24308/24-29 | DDMM50PD |
| M24308/9-6 | DEH9P001 | M24308/23-37 | DEMM9SA | M24308/24-31 | DEMM9PL |
| M24308/9-7 | DAH15P001 | M24308/23-38 | DAMM15SA | M24308/24-32 | DAMM15PL |
| M24308/9-8 | DBH25P001 | M24308/23-39 | DBMM25SA | M24308/24-33 | DBMM25PL |
| M24308/9-9 | DCH37P001 | M24308/23-40 | DCMM37SA | M24308/24-34 | DCMM37PL |
| M24308/9-10 | DDH50P001 | M24308/23-41 | DDMM50SA | M24308/24-35 | DDMM50PL |
| M24308/9-11 | DEH9P202 | M24308/23-43 | DEMM9SG | M24308/24-37 | DEMM9PA |
| M24308/9-12 | DAH15P202 | M24308/23-44 | DAMM15SG | M24308/24-38 | DAMM15PA |
| M24308/9-13 | DBH25P202 | M24308/23-45 | DBMM25SG | M24308/24-39 | DBMM25PA |
| M24308/9-14 | DCH37P202 | M24308/23-46 | DCMM37SG | M24308/24-40 | DCMM37PA |
| M24308/9-15 | DDH50P202 | M24308/23-47 | DDMM50SG | M24308/24-41 | DDMM50PA |
| M24308/9-16 | DEH9P201 | M24308/23-49 | DEMM9SS | M24308/24-43 | DEMM9PG |
| M24308/9-17 | DAH15P201 | M24308/23-50 | DAMM15SS | M24308/24-44 | DAMM15PG |
| M24308/9-18 | DBH25P201 | M24308/23-51 | DBMM25SS | M24308/24-45 | DBMM25PG |
| M24308/9-19 | DCH37P201 | M24308/23-52 | DCMM37SS | M24308/24-46 | DCMM37PG |
| M24308/9-20 | DDH50P201 | M24308/23-53 | DDMM50SS | M24308/24-47 | DDMM50PG |
| M24308/23-1 | DEMM9SM | M24308/23-55 | DEMM9SW | M24308/24-49 | DEMM9PS |
| M24308/23-2 | DAMM15SM | M24308/23-56 | DAMM15SW | M24308/24-50 | DAMM15PS |
| M24308/23-3 | DBMM25SM | M24308/23-57 | DBMM25SW | M24308/24-51 | DBMM25PS |
| M24308/23-4 | DCMM37SM | M24308/23-58 | DCMM37SW | M24308/24-52 | DCMM37PS |
| M24308/23-5 | DDMM50SM | M24308/23-59 | DDMM50SW | M24308/24-53 | DDMM50PS |
| M24308/23-7 | DEMM9SZ | M24308/24-1 | DEMM9PM | M24308/24-55 | DEMM9PW |
| M24308/23-8 | DAMM15SZ | M24308/24-2 | DAMM15PM | M24308/24-56 | DAMM15PW |
| M24308/23-9 | DBMM25SZ | M24308/24-3 | DBMM25PM | M24308/24-57 | DBMM25PW |
| M24308/23-10 | DCMM37SZ | M24308/24-4 | DCMM37PM | M24308/24-58 | DCMM37PW |
| M24308/23-11 | DDMM50SZ | M24308/24-5 | DDMM50PM | M24308/24-59 | DDMM50PW |
| M24308/23-13 | DEMM9SH | M24308/24-7 | DEMM9PZ | M24308/26-1 | D20418-2 |
| M24308/23-14 | DAMM15SH | M24308/24-8 | DAMM15PZ | M24308/26-2 | D20418-39 |
| M24308/23-15 | DBMM25SH | M24308/24-9 | DBMM25PZ | | |
| M24308/23-16 | DCMM37SH | M24308/24-10 | DCMM37PZ | | |
| M24308/23-17 | DDMM50SH | M24308/24-11 | DDMM50PZ | | |
| M24308/23-19 | DEMM9SX | M24308/24-13 | DEMM9PH | | |
| M24308/23-20 | DAMM15SX | M24308/24-14 | DAMM15PH | | |

MIL-C-39029 Crimp Contacts

| Military Part Number | ITT Cannon Part Number | Contact Size | Contact Style | Product Line | MIL Specification |
|----------------------|------------------------|--------------|---------------|--------------|-------------------|
| M39029/63-368 | 031-1007-078 | 20 | Socket | D*MA | 24308-Style |
| M39029/64-369 | 330-5291-097 | 20 | Pin | D*MA | 24308-Style |

HE501/D*M Cross Reference

| HE501 Part Number | ITT Cannon Part Number | HE501 Part Number | ITT Cannon Part Number | HE501 Part Number | ITT Cannon Part Number |
|----------------------|---------------------------|----------------------|---------------------------|----------------------|---------------------------|
| HE501N09AS3 | DEM9S | HE501N9KS33 | DEM9SF179A | HE501N09YP4 | DEM9POL3 |
| HE501N15AS3 | DAM15S | HE501N15KS33 | DAM15SF179A | HE501N15YP4 | DAM15POL3 |
| HE501N25AS3 | DBM25S | HE501N25KS33 | DBM25SF179A | HE501N25YP4 | DBM25POL3 |
| HE501N37AS3 | DCM37S | HE501N37KS33 | DCM37SF179A | HE501N37YP4 | DCM37POL3 |
| HE501N50AS3 | DDM50S | HE501N50KS33 | DDM50SF179A | HE501N50YP4 | DDM50POL3 |
| HE501F09AS3 | DEMY9S | HE501N09AP | DEMY9P | HE501P09VP6E | DEMY9P1A5N |
| HE501F15AS3 | DAMY15S | HE501N15AP | DAMY15P | HE501P15VP6E | DAMY15P1A5N |
| HE501F25AS3 | DBMY25S | HE501N25AP | DBMY25P | HE501P25VP6E | DBMY25P1A5N |
| HE501F37AS3 | DCMY37S | HE501N37AP | DCMY37P | HE501P37VP6E | DCMY37P1A5N |
| HE501F50AS3 | DDMY50S | HE501N50AP | DDMY50P | HE501P50VP6E | DDMY50P1A5N |
| HE501N09YS43 | DEM9SOL3 | HE501F09AP | DEMY9P | HE501N9KP3 | DEM9PF179A |
| HE501N15YS43 | DAM15SOL3 | HE501F15AP | DAMY15P | HE501N15KP3 | DAMY15PF179A |
| HE501N25YS43 | DBM25SOL3 | HE501F25AP | DBMY25P | HE501N25KP3 | DBM25PF179A |
| HE501N37YS43 | DCM37SOL3 | HE501F37AP | DCMY37P | HE501N37KP3 | DCM37PF179A |
| HE501N50YS43 | DDM50SOL3 | HE501F50AP | DDMY50P | HE501N50KP3 | DDM50PF179A |
| HE501P09VS63E | DEM9S1A5N | | | | |
| HE501P15VS63E | DAM15SA15N | | | | |
| HE501P25VS63E | DBM25S1A5N | | | | |
| HE501P37VS63E | DCM37S1A5N | | | | |
| HE501P50VS63E | DDM50S1A5N | | | | |

Coaxial 90° PCB (Sizes DE-DC)

Plug



Reader's Resource

For contact cavity arrangements, see page 222.
 For P.C. hole patterns, see pages 228-229.
 For panel cutouts, see page 221.
 For hardware views (Standard), see page 226.
 For alternate bracket configuration (when connectors are supplied without boardlocks), see page 226.
 For alternate 50 Ohm coaxial configuration, see page 225.

75 Ohm Part Numbers* with Bracket and Rivnut #4-40 UNC

| Shell Size | Layout | Part Number Without Screw Locks Without Boardlocks | Part Number Without Screw Locks With Boardlocks | Part Number With Screw Locks Without Boardlocks | Part Number With Screw Locks With Boardlocks |
|------------|--------|--|---|---|--|
| DE | 5W1 | DEMMP5C1PJ | DEMMC5C1PJ | DEMMD5C1PJ | DEMMG5C1PJ |
| DA | 7W2 | DAMMP7C2PJ | DAMMC7C2PJ | DAMMD7C2PJ | DAMMG7C2PJ |
| DA | 11W1 | DAMMP11C1PJ | DAMMC11C1PJ | DAMMD11C1PJ | DAMMG11C1PJ |
| DA | 3W3 | DAMMP3C3PJ | DAMMC3C3PJ | DAMMD3C3PJ | DAMMG3C3PJ |
| DA | 3WK3♣ | DAMMP3CK3PJTM | DAMMC3CK3PJTM | DAMMD3CK3PJTM | DAMMG3CK3PJTM |
| DB | 5W5 | DBMMP5C5PJ | DBMMC5C5PJ | DBMMD5C5PJ | DBMMG5C5PJ |
| DB | 9W4 | DBMMP9C4PJ | DBMMC9C4PJ | DBMMD9C4PJ | DBMMG9C4PJ |
| DB | 13W3 | DBMMP13C3PJ | DBMMC13C3PJ | DBMMD13C3PJ | DBMMG13C3PJ |
| DB | 17W2 | DBMMP17C2PJ | DBMMC17C2PJ | DBMMD17C2PJ | DBMMG17C2PJ |
| DB | 21W1 | DBMMP21C1PJ | DBMMC21C1PJ | DBMMD21C1PJ | DBMMG21C1PJ |
| DC | 8W8 | DCMMP8C8PJ | DCMMC8C8PJ | DCMMD8C8PJ | DCMMG8C8PJ |
| DC | 13W6 | DCMMP13C6PJ | DCMMC13C6PJ | DCMMD13C6PJ | DCMMG13C6PJ |
| DC | 17W5 | DCMMP17C5PJ | DCMMC17C5PJ | DCMMD17C5PJ | DCMMG17C5PJ |
| DC | 21WA4 | DCMMP21CA4PJ | DCMMC21CA4PJ | DCMMD21CA4PJ | DCMMG21CA4PJ |
| DC | 25W3 | DCMMP25C3PJ | DCMMC25C3PJ | DCMMD25C3PJ | DCMMG25C3PJ |
| DC | 27W2 | DCMMP27C2PJ | DCMMC27C2PJ | DCMMD27C2PJ | DCMMG27C2PJ |

Notes: *For 50 Ohm Coaxial substitute X for C. Example: DEMMP5X1PJ
 For DD shell size, see page 148.
 ♣ Keyed



Note: ♥ Dimension varies with alternate bracket configuration, see Reader's Resource page 226.

Dimensions

| Shell Size | A | B | C | D | E | F | W | W | L |
|------------|---------------|---------------|---------------|--------------|--------------|--------------|----------------|--------------|--------------|
| | ±0.38 (.015) | ±0.13 (.005) | ±0.13 (.005) | ±0.13 (.005) | ±0.38 (.015) | ±0.25 (.010) | ±0.368 (.0145) | ±0.41 (.016) | ±0.25 (.010) |
| DE | 30.81 (1.213) | 16.92 (.666) | 24.99 (.984) | 8.36 (.329) | 12.55 (.494) | 10.72 (.422) | 6.693 (.2635) | — | 0.76 (.030) |
| DA | 39.14 (1.541) | 25.25 (.994) | 33.32 (1.312) | 8.36 (.329) | 12.55 (.494) | 10.72 (.422) | 6.693 (.2635) | — | 0.76 (.030) |
| DB | 53.04 (2.088) | 38.96 (1.534) | 47.04 (1.852) | 8.36 (.329) | 12.55 (.494) | 10.82 (.426) | — | 6.84 (.269) | 0.99 (.039) |
| DC | 69.32 (2.729) | 55.42 (2.182) | 63.50 (2.500) | 8.36 (.329) | 12.55 (.494) | 10.82 (.426) | — | 6.84 (.269) | 0.99 (.039) |

Coaxial 90° PCB (Sizes DE-DC)

Receptacle



Reader's Resource

For contact cavity arrangements, see page 223.
 For P.C. hole patterns, see pages 231-232.
 For panel cutouts, see page 221.
 For hardware views (Standard), see page 226.
 For alternate bracket configuration (when connectors are supplied without boardlocks), see page 226.
 For alternate 50 Ohm coaxial configuration, see page 225.

75 Ohm Part Numbers* with Bracket and Rivnut #4-40 UNC

| Shell Size | Layout | Part Number Without Screw Locks Without Boardlocks | Part Number Without Screw Locks With Boardlocks | Part Number With Screw Locks Without Boardlocks | Part Number With Screw Locks With Boardlocks |
|------------|--------|--|---|---|--|
| DE | 5W1 | DEMMP5C1SJ | DEMMP5C1SJ | DEMMD5C1SJ | DEMMD5C1SJ |
| DA | 7W2 | DAMMP7C2SJ | DAMMP7C2SJ | DAMMD7C2SJ | DAMMD7C2SJ |
| DA | 11W1 | DAMMP11C1SJ | DAMMP11C1SJ | DAMMD11C1SJ | DAMMD11C1SJ |
| DA | 3W3 | DAMMP3C3SJ | DAMMP3C3SJ | DAMMD3C3SJ | DAMMD3C3SJ |
| DA | 3WK3♣ | DAMMP3CK3SJTM | DAMMP3CK3SJTM | DAMMD3CK3SJTM | DAMMD3CK3SJTM |
| DB | 5W5 | DBMMP5C5SJ | DBMMP5C5SJ | DBMMD5C5SJ | DBMMD5C5SJ |
| DB | 9W4 | DBMMP9C4SJ | DBMMP9C4SJ | DBMMD9C4SJ | DBMMD9C4SJ |
| DB | 13W3 | DBMMP13C3SJ | DBMMP13C3SJ | DBMMD13C3SJ | DBMMD13C3SJ |
| DB | 17W2 | DBMMP17C2SJ | DBMMP17C2SJ | DBMMD17C2SJ | DBMMD17C2SJ |
| DB | 21W1 | DBMMP21C1SJ | DBMMP21C1SJ | DBMMD21C1SJ | DBMMD21C1SJ |
| DC | 8W8 | DCMMP8C8SJ | DCMMP8C8SJ | DCMMD8C8SJ | DCMMD8C8SJ |
| DC | 13W6 | DCMMP13C6SJ | DCMMP13C6SJ | DCMMD13C6SJ | DCMMD13C6SJ |
| DC | 17W5 | DCMMP17C5SJ | DCMMP17C5SJ | DCMMD17C5SJ | DCMMD17C5SJ |
| DC | 21WA4 | DCMMP21CA4SJ | DCMMP21CA4SJ | DCMMD21CA4SJ | DCMMD21CA4SJ |
| DC | 25W3 | DCMMP25C3SJ | DCMMP25C3SJ | DCMMD25C3SJ | DCMMD25C3SJ |
| DC | 27W2 | DCMMP27C2SJ | DCMMP27C2SJ | DCMMD27C2SJ | DCMMD27C2SJ |

Notes: *For 50 Ohm Coaxial substitute X for C. Example: DEMMP5X1SJ
 For DD shell size, see page 149.
 ♣ Keyed



Note: ♥ Dimension varies with alternate bracket configuration, see Reader's Resource page 225.

Dimensions

| Shell Size | A | B | C | D | E | F | W | L |
|------------|---------------|---------------|---------------|--------------|--------------|--------------|--------------|--------------|
| | ±0,38 (.015) | ±0,13 (.005) | ±0,13 (.005) | ±0,13 (.005) | ±0,38 (.015) | ±0,25 (.010) | ±0,38 (.015) | ±0,25 (.010) |
| DE | 30,81 (1.213) | 16,33 (.643) | 24,99 (.984) | 7,90 (.311) | 12,55 (.494) | 10,90 (.429) | 6,94 (.273) | 0,76 (.030) |
| DA | 39,14 (1.541) | 24,66 (.971) | 33,32 (1.312) | 7,90 (.311) | 12,55 (.494) | 10,90 (.429) | 6,94 (.273) | 0,76 (.030) |
| DB | 53,04 (2.088) | 38,38 (1.511) | 47,04 (1.852) | 7,90 (.311) | 12,55 (.494) | 10,90 (.429) | 6,94 (.273) | 0,76 (.030) |
| DC | 69,32 (2.729) | 54,84 (2.159) | 63,50 (2.500) | 7,90 (.311) | 12,55 (.494) | 10,90 (.429) | 6,94 (.273) | 0,76 (.030) |

Coaxial 90° PCB (Size DD)

Plug



75 Ohm Part Numbers* with Metal Bracket and Rivnut #4-40 UNC

| Shell Size | Layout | Part Number Without Screw Locks Without Boardlocks | Part Number Without Screw Locks With Boardlocks | Part Number With Screw Locks Without Boardlocks | Part Number With Screw Locks With Boardlocks |
|------------|--------|--|---|---|--|
| DD | 24W7 | DDMMP24C7PJ | DDMMC24C7PJ | DDMMD24C7PJ | DDMMG24C7PJ |
| DD | 36W4 | DDMMP36C4PJ | DDMMC36C4PJ | DDMMD36C4PJ | DDMMG36C4PJ |
| DD | 43W2 | DDMMP43C2PJ | DDMMC43C2PJ | DDMMD43C2PJ | DDMMG43C2PJ |
| DD | 47W1 | DDMMP47C1PJ | DDMMC47C1PJ | DDMMD47C1PJ | DDMMG47C1PJ |

Note: *For 50 Ohm Coaxial substitute X for C. Example: DDMMP24X7PJ

Reader's Resource

- For contact cavity arrangements, see page 222.
- For P.C. hole patterns, see page 230.
- For panel cutouts, see page 221.
- For hardware views (Standard), see page 226.
- For alternate bracket configuration (when connectors are supplied without boardlocks), see page 226.
- For alternate 50 Ohm coaxial configuration, see page 225.



Note: ♥ Dimension varies with alternate bracket configuration, see Reader's Resource page 226.

Dimensions

| Shell Size | A | B | C | D | E | F | W | L |
|------------|---------------|---------------|---------------|--------------|--------------|--------------|--------------|--------------|
| | ±0,38 (.015) | ±0,13 (.005) | ±0,13 (.005) | ±0,13 (.005) | ±0,38 (.015) | ±0,25 (.010) | ±0,41 (.016) | ±0,25 (.010) |
| DD | 66,93 (2.635) | 52,81 (2.079) | 61,11 (2.406) | 11,07 (.436) | 15,37 (.605) | 10,82 (.426) | 6,84 (.269) | 0,99 (.039) |

Coaxial 90° PCB (Size DD)

Receptacle



75 Ohm Part Numbers* with Metal Bracket and Rivnut #4-40 UNC

| Shell Size | Layout | Part Number Without Screw Locks Without Boardlocks | Part Number Without Screw Locks With Boardlocks | Part Number With Screw Locks Without Boardlocks | Part Number With Screw Locks With Boardlocks |
|------------|--------|--|---|---|--|
| DD | 24W7 | DDMMP24C7SJ | DDMMC24C7SJ | DDMMD24C7SJ | DDMMG24C7SJ |
| DD | 36W4 | DDMMP36C4SJ | DDMMC36C4SJ | DDMMD36C4SJ | DDMMG36C4SJ |
| DD | 43W2 | DDMMP43C2SJ | DDMMC43C2SJ | DDMMD43C2SJ | DDMMG43C2SJ |
| DD | 47W1 | DDMMP47C1SJ | DDMMC47C1SJ | DDMMD47C1SJ | DDMMG47C1SJ |

Note: *For 50 Ohm Coaxial substitute X for C. Example: DDMMG36X4SJ

Reader's Resource

- For contact cavity arrangements, see page 223.
- For P.C. hole patterns, see page 233.
- For panel cutouts, see page 221.
- For hardware views (Standard), see page 226.
- For alternate bracket configuration (when connectors are supplied without boardlocks), see page 226.
- For alternate 50 Ohm coaxial configuration, see page 225.



Screw lock, boardlock, and coaxial contacts removed for clarity



Screw lock, boardlock, and signal contacts removed for clarity



Note: ♥ Dimension varies with alternate bracket configuration, see Reader's Resource page 226.

Dimensions

| Shell Size | A | B | C | D | E | F | W | L |
|------------|---------------|---------------|---------------|--------------|--------------|--------------|--------------|--------------|
| | ±0,38 (.015) | ±0,13 (.005) | ±0,13 (.005) | ±0,13 (.005) | ±0,38 (.015) | ±0,25 (.010) | ±0,38 (.015) | ±0,25 (.010) |
| DD | 66,93 (2.635) | 52,42 (2.064) | 61,11 (2.406) | 10,74 (.423) | 15,37 (.605) | 10,90 (.429) | 6,94 (.273) | 0,76 (.030) |

Coaxial Straight PCB (Sizes DE-DC)

Plug



Reader's Resource

For contact cavity arrangements, see page 222.
 For P.C. hole patterns, see pages 238-239.
 For panel cutouts, see page 221.
 For hardware views (Standard), see page 226.
 For alternate 50 Ohm coaxial configuration, see page 225.

75 Ohm Part Numbers* with Standoff #4-40 UNC

| Shell Size | Layout | Part Number Without Screw Locks Without Boardlocks | Part Number Without Screw Locks With Boardlocks | Part Number With Screw Locks With Boardlocks |
|------------|--------|--|---|--|
| DE | 5W1 | DEMMV5C1PN | DEMMZ5C1PN | DEMMN5C1PN |
| DA | 7W2 | DAMMV7C2PN | DAMMZ7C2PN | DAMMN7C2PN |
| DA | 11W1 | DAMMV11C1PN | DAMMZ11C1PN | DAMMN11C1PN |
| DA | 3W3 | DAMMV3C3PN | DAMMZ3C3PN | DAMMN3C3PN |
| DA | 3WK3♣ | DAMMV3CK3PNTM | DAMMZ3CK3PNTM | DAMMN3CK3PNTM |
| DB | 5W5 | DBMMV5C5PN | DBMMZ5C5PN | DBMMN5C5PN |
| DB | 9W4 | DBMMV9C4PN | DBMMZ9C4PN | DBMMN9C4PN |
| DB | 13W3 | DBMMV13C3PN | DBMMZ13C3PN | DBMMN13C3PN |
| DB | 17W2 | DBMMV17C2PN | DBMMZ17C2PN | DBMMN17C2PN |
| DB | 21W1 | DBMMV21C1PN | DBMMZ21C1PN | DBMMN21C1PN |
| DC | 8W8 | DCMMV8C8PN | DCMMZ8C8PN | DCMMN8C8PN |
| DC | 13W6 | DCMMV13C6PN | DCMMZ13C6PN | DCMMN13C6PN |
| DC | 17W5 | DCMMV17C5PN | DCMMZ17C5PN | DCMMN17C5PN |
| DC | 21WA4 | DCMMV21CA4PN | DCMMZ21CA4PN | DCMMN21CA4PN |
| DC | 25W3 | DCMMV25C3PN | DCMMZ25C3PN | DCMMN25C3PN |
| DC | 27W2 | DCMMV27C2PN | DCMMZ27C2PN | DCMMN27C2PN |

Notes: *For 50 Ohm Coaxial substitute X for C. Example: DEMMV5X1PN
 For DD shell size, see page 152.
 ♣ Keyed



Screw lock, boardlock, and signal contacts removed for clarity



Screw lock, boardlock, and coaxial contact removed for clarity

Dimensions

| Shell Size | A | B | C | D | E | F | W | W | L |
|------------|---------------|---------------|---------------|--------------|--------------|--------------|----------------|--------------|--------------|
| | ±0,38 (.015) | ±0,13 (.005) | ±0,13 (.005) | ±0,13 (.005) | ±0,38 (.015) | ±0,25 (.010) | ±0,368 (.0145) | ±0,41 (.016) | ±0,25 (.010) |
| DE | 30,81 (1.213) | 16,92 (.666) | 24,99 (.984) | 8,36 (.329) | 12,55 (.494) | 10,72 (.422) | 6,693 (.2635) | — | 0,76 (.030) |
| DA | 39,14 (1.541) | 25,25 (.994) | 33,32 (1.312) | 8,36 (.329) | 12,55 (.494) | 10,72 (.422) | 6,693 (.2635) | — | 0,76 (.030) |
| DB | 53,04 (2.088) | 38,96 (1.534) | 47,04 (1.852) | 8,36 (.329) | 12,55 (.494) | 10,82 (.426) | — | 6,84 (.269) | 0,99 (.039) |
| DC | 69,32 (2.729) | 55,42 (2.182) | 63,50 (2.500) | 8,36 (.329) | 12,55 (.494) | 10,82 (.426) | — | 6,84 (.269) | 0,99 (.039) |

Coaxial Straight PCB (Sizes DE-DC)

Receptacle



Reader's Resource

For contact cavity arrangements, see page 223.
 For P.C. hole patterns, see pages 241-242.
 For panel cutouts, see page 221.
 For hardware views (Standard), see page 226.
 For alternate 50 Ohm coaxial configuration, see page 225.

75 Ohm Part Numbers* with Standoff #4-40 UNC

| Shell Size | Layout | Part Number Without Screw Locks Without Boardlocks | Part Number Without Screw Locks With Boardlocks | Part Number With Screw Locks With Boardlocks |
|------------|--------|--|---|--|
| DE | 5W1 | DEMMV5C1SN | DEMMZ5C1SN | DEMMN5C1SN |
| DA | 7W2 | DAMMV7C2SN | DAMMZ7C2SN | DAMMN7C2SN |
| DA | 11W1 | DAMMV11C1SN | DAMMZ11C1SN | DAMMN11C1SN |
| DA | 3W3 | DAMMV3C3SN | DAMMZ3C3SN | DAMMN3C3SN |
| DA | 3WK3♣ | DAMMV3CK3SNTM | DAMMZ3CK3SNTM | DAMMN3CK3SNTM |
| DB | 5W5 | DBMMV5C5SN | DBMMZ5C5SN | DBMMN5C5SN |
| DB | 9W4 | DBMMV9C4SN | DBMMZ9C4SN | DBMMN9C4SN |
| DB | 13W3 | DBMMV13C3SN | DBMMZ13C3SN | DBMMN13C3SN |
| DB | 17W2 | DBMMV17C2SN | DBMMZ17C2SN | DBMMN17C2SN |
| DB | 21W1 | DBMMV21C1SN | DBMMZ21C1SN | DBMMN21C1SN |
| DC | 8W8 | DCMMV8C8SN | DCMMZ8C8SN | DCMMN8C8SN |
| DC | 13W6 | DCMMV13C6SN | DCMMZ13C6SN | DCMMN13C6SN |
| DC | 17W5 | DCMMV17C5SN | DCMMZ17C5SN | DCMMN17C5SN |
| DC | 21WA4 | DCMMV21CA4SN | DCMMZ21CA4SN | DCMMN21CA4SN |
| DC | 25W3 | DCMMV25C3SN | DCMMZ25C3SN | DCMMN25C3SN |
| DC | 27W2 | DCMMV27C2SN | DCMMZ27C2SN | DCMMN27C2SN |

Notes: *For 50 Ohm Coaxial substitute X for C. Example: DEMMV5X1SN
 For DD shell size, see page 153.
 ♣ Keyed



Screw lock, boardlock, and signal contacts removed for clarity



Hardware and coaxial contact removed for clarity

Dimensions

| Shell Size | A | B | C | D | E | F | W | L |
|------------|---------------|---------------|---------------|--------------|--------------|--------------|--------------|--------------|
| | ±0,38 (.015) | ±0,13 (.005) | ±0,13 (.005) | ±0,13 (.005) | ±0,38 (.015) | 0,25 (.010) | ±0,38 (.015) | ±0,25 (.010) |
| DE | 30,81 (1.213) | 16,33 (.643) | 24,99 (.984) | 7,90 (.311) | 12,55 (.494) | 10,90 (.429) | 6,94 (.273) | 0,76 (.030) |
| DA | 39,14 (1.541) | 24,66 (.971) | 33,32 (1.312) | 7,90 (.311) | 12,55 (.494) | 10,90 (.429) | 6,94 (.273) | 0,76 (.030) |
| DB | 53,04 (2.088) | 38,38 (1.511) | 47,04 (1.852) | 7,90 (.311) | 12,55 (.494) | 10,90 (.429) | 6,94 (.273) | 0,76 (.030) |
| DC | 69,32 (2.729) | 54,84 (2.159) | 63,50 (2.500) | 7,90 (.311) | 12,55 (.494) | 10,90 (.429) | 6,94 (.273) | 0,76 (.030) |

Coaxial Straight PCB (Size DD)

Plug



75 Ohm Part Numbers* with Standoff #4-40 UNC

| Shell Size | Layout | Part Number Without Screw Locks Without Boardlocks | Part Number Without Screw Locks With Boardlocks | Part Number With Screw Locks With Boardlocks |
|------------|--------|--|---|--|
| DD | 24W7 | DDMMV24C7PN | DDMMZ24C7PN | DDMMN24C7PN |
| DD | 36W4 | DDMMV36C4PN | DDMMZ36C4PN | DDMMN36C4PN |
| DD | 43W2 | DDMMV43C2PN | DDMMZ43C2PN | DDMMN43C2PN |
| DD | 47W1 | DDMMV47C1PN | DDMMZ47C1PN | DDMMN47C1PN |

Note: *For 50 Ohm Coaxial substitute X for C. Example: DDMMV24XPN

Reader's Resource

- For contact cavity arrangements, see page 222.
- For P.C. hole patterns, see page 256.
- For panel cutouts, see page 221.
- For hardware views (Standard), see page 226.
- For alternate 50 Ohm coaxial configuration, see page 225.



Screw lock, boardlock, and signal contacts removed for clarity



Screw lock, boardlock, and coaxial contact removed for clarity

Dimensions

| Shell Size | A | B | C | D | E | F | W | L |
|------------|---------------|---------------|---------------|--------------|--------------|--------------|--------------|--------------|
| | ±0,38 (.015) | ±0,13 (.005) | ±0,13 (.005) | ±0,13 (.005) | ±0,38 (.015) | ±0,25 (.010) | ±0,41 (.016) | ±0,25 (.010) |
| DD | 66,93 (2.635) | 52,81 (2.079) | 61,11 (2.406) | 11,07 (.436) | 15,37 (.605) | 10,82 (.426) | 6,84 (.269) | 0,99 (.039) |

Coaxial Straight PCB (Size DD)

Receptacle



75 Ohm Part Numbers* with Standoff #4-40 UNC

| Shell Size | Layout | Part Number Without Screw Locks Without Boardlocks | Part Number Without Screw Locks With Boardlocks | Part Number With Screw Locks With Boardlocks |
|------------|--------|--|---|--|
| DD | 24W7 | DDMMV24C7SN | DDMMZ24C7SN | DDMMN24C7SN |
| DD | 36W4 | DDMMV36C4SN | DDMMZ36C4SN | DDMMN36C4SN |
| DD | 43W2 | DDMMV43C2SN | DDMMZ43C2SN | DDMMN43C2SN |
| DD | 47W1 | DDMMV47C1SN | DDMMZ47C1SN | DDMMN47C1SN |

Note: *For 50 Ohm Coaxial substitute X for C. Example: DDMMV24X7SN

Reader's Resource

For contact cavity arrangements, see page 223.

For P.C. hole patterns, see page 259.

For panel cutouts, see page 221.

For hardware views (Standard), see page 226.

For alternate 50 Ohm coaxial configuration, see page 225.



Screw lock, boardlock, and signal contacts removed for clarity



Screw lock, boardlock, and coaxial contact removed for clarity

Dimensions

| Shell Size | A | B | C | D | E | F | W | L |
|------------|---------------|---------------|---------------|--------------|--------------|--------------|--------------|--------------|
| | ±0,38 (.015) | ±0,13 (.005) | ±0,13 (.005) | ±0,13 (.005) | ±0,38 (.015) | ±0,25 (.010) | ±0,38 (.015) | ±0,25 (.010) |
| DD | 66,93 (2.635) | 52,42 (2.064) | 61,11 (2.406) | 10,74 (.423) | 15,37 (.605) | 10,90 (.429) | 6,94 (.273) | 0,76 (.030) |

40 A High Power 90° PCB (Sizes DE-DC)

Plug



Part Numbers with Metal Bracket and Rivnut #4-40 UNC

| Shell Size | Layout | Part Number Without Screw Locks Without Boardlocks | Part Number Without Screw Locks With Boardlocks | Part Number With Screw Locks Without Boardlocks | Part Number With Screw Locks With Boardlocks |
|------------|--------|--|---|---|--|
| DE | 5W1 | DEMMP5H1PJ | DEMNC5H1PJ | DEMMD5H1PJ | DEMMG5H1PJ |
| DA | 7W2 | DAMMP7H2PJ | DAMMC7H2PJ | DAMMD7H2PJ | DAMMG7H2PJ |
| DA | 11W1 | DAMMP11H1PJ | DAMMC11H1PJ | DAMMD11H1PJ | DAMMG11H1PJ |
| DA | 3W3 | DAMMP3H3PJ | DAMMC3H3PJ | DAMMD3H3PJ | DAMMG3H3PJ |
| DA | 3WK3♣ | DAMMP3HK3PJTM | DAMMC3HK3PJTM | DAMMD3HK3PJTM | DAMMG3HK3PJTM |
| DB | 5W5 | DBMMP5H5PJ | DBMMC5H5PJ | DBMMD5H5PJ | DBMMG5H5PJ |
| DB | 9W4 | DBMMP9H4PJ | DBMMC9H4PJ | DBMMD9H4PJ | DBMMG9H4PJ |
| DB | 13W3 | DBMMP13H3PJ | DBMMC13H3PJ | DBMMD13H3PJ | DBMMG13H3PJ |
| DB | 17W2 | DBMMP17H2PJ | DBMMC17H2PJ | DBMMD17H2PJ | DBMMG17H2PJ |
| DB | 21W1 | DBMMP21H1PJ | DBMMC21H1PJ | DBMMD21H1PJ | DBMMG21H1PJ |
| DC | 8W8 | DCMMP8H8PJ | DCMMC8H8PJ | DCMMD8H8PJ | DCMMG8H8PJ |
| DC | 13W6 | DCMMP13H6PJ | DCMMC13H6PJ | DCMMD13H6PJ | DCMMG13H6PJ |
| DC | 17W5 | DCMMP17H5PJ | DCMMC17H5PJ | DCMMD17H5PJ | DCMMG17H5PJ |
| DC | 21WA4 | DCMMP21HA4PJ | DCMMC21HA4PJ | DCMMD21HA4PJ | DCMMG21HA4PJ |
| DC | 25W3 | DCMMP25H3PJ | DCMMC25H3PJ | DCMMD25H3PJ | DCMMG25H3PJ |
| DC | 27W2 | DCMMP27H2PJ | DCMMC27H2PJ | DCMMD27H2PJ | DCMMG27H2PJ |

Reader's Resource

For contact cavity arrangements, see page 222.
 For P.C. hole patterns, see pages 244-245.
 For panel cutouts, see page 221.
 For hardware views (Standard), see page 226.
 For alternate bracket configuration (when connectors are supplied without boardlocks), see page 226.

Notes: For DD shell size, see page 156.

♣ Keyed



Note: ♥ Dimension varies with alternate bracket configuration, see Reader's Resource page 226.

Dimensions

| Shell Size | A | B | C | D | E | F | W | W | L |
|------------|-------------------|-------------------|-------------------|-------------------|-------------------|-------------------|---------------------|-------------------|-------------------|
| | $\pm 0,38 (.015)$ | $\pm 0,13 (.005)$ | $\pm 0,13 (.005)$ | $\pm 0,13 (.005)$ | $\pm 0,38 (.015)$ | $\pm 0,25 (.010)$ | $\pm 0,368 (.0145)$ | $\pm 0,41 (.016)$ | $\pm 0,25 (.010)$ |
| DE | 30,81 (1.213) | 16,92 (.666) | 24,99 (.984) | 8,36 (.329) | 12,55 (.494) | 10,72 (.422) | 6,693 (.2635) | — | 0,76 (.030) |
| DA | 39,14 (1.541) | 25,25 (.994) | 33,32 (1.312) | 8,36 (.329) | 12,55 (.494) | 10,72 (.422) | 6,693 (.2635) | — | 0,76 (.030) |
| DB | 53,04 (2.088) | 38,96 (1.534) | 47,04 (1.852) | 8,36 (.329) | 12,55 (.494) | 10,82 (.426) | — | 6,84 (.269) | 0,99 (.039) |
| DC | 69,32 (2.729) | 55,42 (2.182) | 63,50 (2.500) | 8,36 (.329) | 12,55 (.494) | 10,82 (.426) | — | 6,84 (.269) | 0,99 (.039) |

40 A High Power 90° PCB (Sizes DE-DC)

Receptacle



Reader's Resource

- For contact cavity arrangements, see page 223.
- For P.C. hole patterns, see pages 247-248.
- For panel cutouts, see page 221.
- For hardware views (Standard), see page 226.
- For alternate bracket configuration (when connectors are supplied without boardlocks), see page 226.

Part Numbers with Metal Bracket and Rivnut #4-40 UNC

| Shell Size | Layout | Part Number Without Screw Locks Without Boardlocks | Part Number Without Screw Locks With Boardlocks | Part Number With Screw Locks Without Boardlocks | Part Number With Screw Locks With Boardlocks |
|------------|--------|--|---|---|--|
| DE | 5W1 | DEMMP5H1SJ | DEMCC5H1SJ | DEMMD5H1SJ | DEMMG5H1SJ |
| DA | 7W2 | DAMMP7H2SJ | DAMMC7H2SJ | DAMMD7H2SJ | DAMMG7H2SJ |
| DA | 11W1 | DAMMP11H1SJ | DAMMC11H1SJ | DAMMD11H1SJ | DAMMG11H1SJ |
| DA | 3W3 | DAMMP3H3SJ | DAMMC3H3SJ | DAMMD3H3SJ | DAMMG3H3SJ |
| DA | 3WK3♣ | DAMMP3HK3SJTM | DAMMC3HK3SJTM | DAMMD3HK3SJTM | DAMMG3HK3SJTM |
| DB | 5W5 | DBMMP5H5SJ | DBMMC5H5SJ | DBMMD5H5SJ | DBMMG5H5SJ |
| DB | 9W4 | DBMMP9H4SJ | DBMMC9H4SJ | DBMMD9H4SJ | DBMMG9H4SJ |
| DB | 13W3 | DBMMP13H3SJ | DBMMC13H3SJ | DBMMD13H3SJ | DBMMG13H3SJ |
| DB | 17W2 | DBMMP17H2SJ | DBMMC17H2SJ | DBMMD17H2SJ | DBMMG17H2SJ |
| DB | 21W1 | DBMMP21H1SJ | DBMMC21H1SJ | DBMMD21H1SJ | DBMMG21H1SJ |
| DC | 8W8 | DCMMP8H8SJ | DCMMC8H8SJ | DCMMD8H8SJ | DCMMG8H8SJ |
| DC | 13W6 | DCMMP13H6SJ | DCMMC13H6SJ | DCMMD13H6SJ | DCMMG13H6SJ |
| DC | 17W5 | DCMMP17H5SJ | DCMMC17H5SJ | DCMMD17H5SJ | DCMMG17H5SJ |
| DC | 21WA4 | DCMMP21HA4SJ | DCMMC21HA4SJ | DCMMD21HA4SJ | DCMMG21HA4SJ |
| DC | 25W3 | DCMMP25H3SJ | DCMMC25H3SJ | DCMMD25H3SJ | DCMMG25H3SJ |
| DC | 27W2 | DCMMP27H2SJ | DCMMC27H2SJ | DCMMD27H2SJ | DCMMG27H2SJ |

Notes: For DD shell size, see page 157.

♣ Keyed.



Note: ♥ Dimension varies with alternate bracket configuration, see Reader's Resource page 226.

Dimensions

| Shell Size | A ±0,38 (.015) | B ±0,13 (.005) | C ±0,13 (.005) | D ±0,13 (.005) | E ±0,38 (.015) | F ±0,25 (.010) | W ±0,38 (.015) | L ±0,25 (.010) |
|------------|-------------------|-------------------|-------------------|-------------------|-------------------|-------------------|-------------------|-------------------|
| DE | 30,81 (1.213) | 16,33 (.643) | 24,99 (.984) | 7,90 (.311) | 12,55 (.494) | 10,90 (.429) | 6,94 (.273) | 0,76 (.030) |
| DA | 39,14 (1.541) | 24,66 (.971) | 33,32 (1.312) | 7,90 (.311) | 12,55 (.494) | 10,90 (.429) | 6,94 (.273) | 0,76 (.030) |
| DB | 53,04 (2.088) | 38,38 (1.511) | 47,04 (1.852) | 7,90 (.311) | 12,55 (.494) | 10,90 (.429) | 6,94 (.273) | 0,76 (.030) |
| DC | 69,32 (2.729) | 54,84 (2.159) | 63,50 (2.500) | 7,90 (.311) | 12,55 (.494) | 10,90 (.429) | 6,94 (.273) | 0,76 (.030) |

40 A High Power 90° PCB (Size DD)

Plug



Part Numbers with Metal Bracket and Rivnut #4-40 UNC

| Shell Size | Layout | Part Number Without Screw Locks Without Boardlocks | Part Number Without Screw Locks With Boardlocks | Part Number With Screw Locks Without Boardlocks | Part Number With Screw Locks With Boardlocks |
|------------|--------|--|---|---|--|
| DD | 24W7 | DDMMP24H7PJ | DDMMC24H7PJ | DDMMD24H7PJ | DDMMG24H7PJ |
| DD | 36W4 | DDMMP36H4PJ | DDMMC36H4PJ | DDMMD36H4PJ | DDMMG36H4PJ |
| DD | 43W2 | DDMMP43H2PJ | DDMMC43H2PJ | DDMMD43H2PJ | DDMMG43H2PJ |
| DD | 47W1 | DDMMP47H1PJ | DDMMC47H1PJ | DDMMD47H1PJ | DDMMG47H1PJ |

Reader's Resource

- For contact cavity arrangements, see page 222.
- For P.C. hole patterns, see page 246.
- For panel cutouts, see page 221.
- For hardware views (Standard), see page 226.
- For alternate bracket configuration (when connectors are supplied without boardlocks), see page 226.



Screw lock, boardlock, and signal contacts removed for clarity



Screw lock, boardlock, and high power contact removed for clarity

Note: ♥ Dimension varies with alternate bracket configuration, see Reader's Resource page 226.

Dimensions

| Shell Size | A | B | C | D | E | F | W | L |
|------------|---------------|---------------|---------------|--------------|--------------|--------------|--------------|--------------|
| | ±0,38 (.015) | ±0,13 (.005) | ±0,13 (.005) | ±0,13 (.005) | ±0,38 (.015) | ±0,25 (.010) | ±0,41 (.016) | ±0,25 (.010) |
| DD | 66,93 (2.635) | 52,81 (2.079) | 61,11 (2.406) | 11,07 (.436) | 15,37 (.605) | 10,82 (.426) | 6,84 (.269) | 0,99 (.039) |

40 A High Power 90° PCB (Size DD)

Receptacle



Part Numbers with Metal Bracket and Rivnut #4-40 UNC

| Shell Size | Layout | Part Number Without Screw Locks Without Boardlocks | Part Number Without Screw Locks With Boardlocks | Part Number With Screw Locks Without Boardlocks | Part Number With Screw Locks With Boardlocks |
|------------|--------|--|---|---|--|
| DD | 24W7 | DDMMP24H7SJ | DDMMC24H7SJ | DDMMD24H7SJ | DDMMG24H7SJ |
| DD | 36W4 | DDMMP36H4SJ | DDMMC36H4SJ | DDMMD36H4SJ | DDMMG36H4SJ |
| DD | 43W2 | DDMMP43H2SJ | DDMMC43H2SJ | DDMMD43H2SJ | DDMMG43H2SJ |
| DD | 47W1 | DDMMP47H1SJ | DDMMC47H1SJ | DDMMD47H1SJ | DDMMG47H1SJ |

Reader's Resource

- For contact cavity arrangements, see page 223.
- For P.C. hole patterns, see page 249.
- For panel cutouts, see page 221.
- For hardware views (Standard), see page 226.
- For alternate bracket configuration (when connectors are supplied without boardlocks), see page 226.

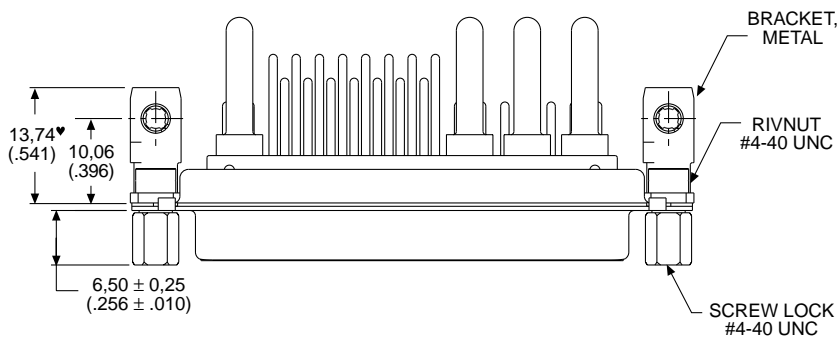

Note: ♥ Dimension varies with alternate bracket configuration, see Reader's Resource page 226.

Dimensions

| Shell Size | A | B | C | D | E | F | W | L |
|------------|---------------|---------------|---------------|--------------|--------------|--------------|--------------|--------------|
| | ±0,38 (.015) | ±0,13 (.005) | ±0,13 (.005) | ±0,13 (.005) | ±0,38 (.015) | ±0,25 (.010) | ±0,38 (.015) | ±0,25 (.010) |
| DD | 66,93 (2.635) | 52,42 (2.064) | 61,11 (2.406) | 10,74 (.423) | 15,37 (.605) | 10,90 (.429) | 6,94 (.273) | 0,76 (.030) |

40 A High Power Straight PCB (Sizes DE-DC)

Plug



Reader's Resource

For contact cavity arrangements, see page 222.
 For P.C. hole patterns, see pages 254-255.
 For panel cutouts, see page 221.
 For hardware views (Standard), see page 226.

Part Numbers with Standoff #4-40 UNC

| Shell Size | Layout | Part Number Without Screw Locks Without Boardlocks | Part Number Without Screw Locks With Boardlocks | Part Number With Screw Locks With Boardlocks |
|------------|--------|--|---|--|
| DE | 5W1 | DEMMV5H1PN | DEMMZ5H1PN | DEMMN5H1PN |
| DA | 7W2 | DAMMV7H2PN | DAMMZ7H2PN | DAMMN7H2PN |
| DA | 11W1 | DAMMV11H1PN | DAMMZ11H1PN | DAMMN11H1PN |
| DA | 3W3 | DAMMV3H3PN | DAMMZ3H3PN | DAMMN3H3PN |
| DA | 3WK3♣ | DAMMV3HK3PNTM | DAMMZ3HK3PNTM | DAMMN3HK3PNTM |
| DB | 5W5 | DBMMV5H5PN | DBMMZ5H5PN | DBMMN5H5PN |
| DB | 9W4 | DBMMV9H4PN | DBMMZ9H4PN | DBMMN9H4PN |
| DB | 13W3 | DBMMV13H3PN | DBMMZ13H3PN | DBMMN13H3PN |
| DB | 17W2 | DBMMV17H2PN | DBMMZ17H2PN | DBMMN17H2PN |
| DB | 21W1 | DBMMV21H1PN | DBMMZ21H1PN | DBMMN21H1PN |
| DC | 8W8 | DCMMV8H8PN | DCMMZ8H8PN | DCMMN8H8PN |
| DC | 13W6 | DCMMV13H6PN | DCMMZ13H6PN | DCMMN13H6PN |
| DC | 17W5 | DCMMV17H5PN | DCMMZ17H5PN | DCMMN17H5PN |
| DC | 21WA4 | DCMMV21HA4PN | DCMMZ21HA4PN | DCMMN21HA4PN |
| DC | 25W3 | DCMMV25H3PN | DCMMZ25H3PN | DCMMN25H3PN |
| DC | 27W2 | DCMMV27H2PN | DCMMZ27H2PN | DCMMN27H2PN |

Notes: For DD shell sizes, see page 160.
 ♣ Keyed.



Dimensions

| Shell Size | A ±0.38 (.015) | B ±0.13 (.005) | C ±0.13 (.005) | D ±0.13 (.005) | E ±0.38 (.015) | F ±0.25 (.010) | W ±0.368 (.0145) | W ±0.41 (.016) | L ±0.25 (.010) |
|------------|-------------------|-------------------|-------------------|-------------------|-------------------|-------------------|---------------------|-------------------|-------------------|
| DE | 30.81 (1.213) | 16.92 (.666) | 24.99 (.984) | 8.36 (.329) | 12.55 (.494) | 10.72 (.422) | 6.693 (.2635) | — | 0.76 (.030) |
| DA | 39.14 (1.541) | 25.25 (.994) | 33.32 (1.312) | 8.36 (.329) | 12.55 (.494) | 10.72 (.422) | 6.693 (.2635) | — | 0.76 (.030) |
| DB | 53.04 (2.088) | 38.96 (1.534) | 47.04 (1.852) | 8.36 (.329) | 12.55 (.494) | 10.82 (.426) | — | 6.84 (.269) | 0.99 (.039) |
| DC | 69.32 (2.729) | 55.42 (2.182) | 63.50 (2.500) | 8.36 (.329) | 12.55 (.494) | 10.82 (.426) | — | 6.84 (.269) | 0.99 (.039) |

40 A High Power Straight PCB (Sizes DE-DC)

Receptacle



Reader's Resource

- For contact cavity arrangements, see page 223.
- For P.C. hole patterns, see pages 257-258.
- For panel cutouts, see page 221.
- For hardware views (Standard), see page 226.

Part Numbers with Standoff #4-40 UNC

| Shell Size | Layout | Part Number Without Screw Locks Without Boardlocks | Part Number Without Screw Locks With Boardlocks | Part Number With Screw Locks With Boardlocks |
|------------|--------|--|---|--|
| DE | 5W1 | DEMMV5H1SN | DEMMZ5H1SN | DEMMN5H1SN |
| DA | 7W2 | DAMMV7H2SN | DAMMZ7H2SN | DAMMN7H2SN |
| DA | 11W1 | DAMMV11H1SN | DAMMZ11H1SN | DAMMN11H1SN |
| DA | 3W3 | DAMMV3H3SN | DAMMZ3H3SN | DAMMN3H3SN |
| DA | 3WK3♣ | DAMMV3HK3SNTM | DAMMZ3HK3SNTM | DAMMN3HK3SNTM |
| DB | 5W5 | DBMMV5H5SN | DBMMZ5H5SN | DBMMN5H5SN |
| DB | 9W4 | DBMMV9H4SN | DBMMZ9H4SN | DBMMN9H4SN |
| DB | 13W3 | DBMMV13H3SN | DBMMZ13H3SN | DBMMN13H3SN |
| DB | 17W2 | DBMMV17H2SN | DBMMZ17H2SN | DBMMN17H2SN |
| DB | 21W1 | DBMMV21H1SN | DBMMZ21H1SN | DBMMN21H1SN |
| DC | 8W8 | DCMMV8H8SN | DCMMZ8H8SN | DCMMN8H8SN |
| DC | 13W6 | DCMMV13H6SN | DCMMZ13H6SN | DCMMN13H6SN |
| DC | 17W5 | DCMMV17H5SN | DCMMZ17H5SN | DCMMN17H5SN |
| DC | 21WA4 | DCMMV21HA4SN | DCMMZ21HA4SN | DCMMN21HA4SN |
| DC | 25W3 | DCMMV25H3SN | DCMMZ25H3SN | DCMMN25H3SN |
| DC | 27W2 | DCMMV27H2SN | DCMMZ27H2SN | DCMMN27H2SN |

Notes: For DD shell sizes, see page 161.

♣ Keyed.

Engaging Face



Screw lock, boardlock and high power contact removed for clarity

Dimensions

| Shell Size | A | B | C | D | E | F | W | L |
|------------|---------------|---------------|---------------|--------------|--------------|--------------|--------------|--------------|
| | ±0,38 (.015) | ±0,13 (.005) | ±0,13 (.005) | ±0,13 (.005) | ±0,38 (.015) | ±0,25 (.010) | ±0,38 (.015) | ±0,25 (.010) |
| DE | 30,81 (1.213) | 16,33 (.643) | 24,99 (.984) | 7,90 (.311) | 12,55 (.494) | 10,90 (.429) | 6,94 (.273) | 0,76 (.030) |
| DA | 39,14 (1.541) | 24,66 (.971) | 33,32 (1.312) | 7,90 (.311) | 12,55 (.494) | 10,90 (.429) | 6,94 (.273) | 0,76 (.030) |
| DB | 53,04 (2.088) | 38,38 (1.511) | 47,04 (1.852) | 7,90 (.311) | 12,55 (.494) | 10,90 (.429) | 6,94 (.273) | 0,76 (.030) |
| DC | 69,32 (2.729) | 54,84 (2.159) | 63,50 (2.500) | 7,90 (.311) | 12,55 (.494) | 10,90 (.429) | 6,94 (.273) | 0,76 (.030) |

40 A High Power Straight PCB (Size DD)

Plug



Part Numbers with Standoff #4-40 UNC

| Shell Size | Layout | Part Number Without Screw Locks Without Boardlocks | Part Number Without Screw Locks With Boardlocks | Part Number With Screw Locks With Boardlocks |
|------------|--------|--|---|--|
| DD | 24W7 | DDMMV24H7PN | DDMMZ24H7PN | DDMMN24H7PN |
| DD | 36W4 | DDMMV36H4PN | DDMMZ36H4PN | DDMMN36H4PN |
| DD | 43W2 | DDMMV43H2PN | DDMMZ43H2PN | DDMMN43H2PN |
| DD | 47W1 | DDMMV47H1PN | DDMMZ47H1PN | DDMMN47H1PN |

Reader's Resource

For contact cavity arrangements, see page 222.

For P.C. hole patterns, see page 256.

For panel cutouts, see page 221.

For hardware views (Standard), see page 226.



Screw lock, boardlock, and high power contact removed for clarity

Dimensions

| Shell Size | A | B | C | D | E | F | W | L |
|------------|---------------|---------------|---------------|--------------|--------------|--------------|--------------|--------------|
| DD | ±0.38 (.015) | ±0.13 (.005) | ±0.13 (.005) | ±0.13 (.005) | ±0.38 (.015) | ±0.25 (.010) | ±0.41 (.016) | ±0.25 (.010) |
| | 66,93 (2.635) | 52,81 (2.079) | 61,11 (2.406) | 11,07 (.436) | 15,37 (.605) | 10,82 (.426) | 6,84 (.269) | 0,99 (.039) |

40 A High Power Straight PCB (Size DD)

Receptacle



Part Numbers with Standoff #4-40 UNC

| Shell Size | Layout | Part Number Without Screw Locks Without Boardlocks | Part Number Without Screw Locks With Boardlocks | Part Number With Screw Locks With Boardlocks |
|------------|--------|--|---|--|
| DD | 24W7 | DDMMV24H7SN | DDMMZ24H7SN | DDMMN24H7SN |
| DD | 36W4 | DDMMV36H4SN | DDMMZ36H4SN | DDMMN36H4SN |
| DD | 43W2 | DDMMV43H2SN | DDMMZ43H2SN | DDMMN43H2SN |
| DD | 47W1 | DDMMV47H1SN | DDMMZ47H1SN | DDMMN47H1SN |

Reader's Resource

For contact cavity arrangements, see page 223.

For P.C. hole patterns, see page 259.

For panel cutouts, see page 221.

For hardware views (Standard), see page 226.



Dimensions

| Shell Size | A ±0,38 (.015) | B ±0,13 (.005) | C ±0,13 (.005) | D ±0,13 (.005) | E ±0,38 (.015) | F ±0,25 (.010) | W ±0,38 (.015) | L ±0,25 (.010) |
|------------|-------------------|-------------------|-------------------|-------------------|-------------------|-------------------|-------------------|-------------------|
| DD | 66,93 (2.635) | 52,42 (2.064) | 61,11 (2.406) | 10,74 (.423) | 15,37 (.605) | 10,90 (.429) | 6,94 (.273) | 0,76 (.030) |

High Voltage Straight PCB (Sizes DE-DC)

Plug



Reader's Resource

For contact cavity arrangements, see page 222.
 For P.C. hole patterns, see pages 254-255.
 For panel cutouts, see page 221.
 For hardware views (Standard), see page 226.

Part Numbers with Standoff #4-40 UNC

| Shell Size | Layout | Part Number Without Screw Locks Without Boardlocks | Part Number Without Screw Locks With Boardlocks | Part Number With Screw Locks With Boardlocks |
|------------|--------|--|---|--|
| DE | 5W1 | DEMMV5V1PN | DEMMSV5V1PN | DEMMN5V1PN |
| DA | 7W2 | DAMMV7V2PN | DAMMZ7V2PN | DAMMN7V2PN |
| DA | 11W1 | DAMMV11V1PN | DAMMZ11V1PN | DAMMN11V1PN |
| DA | 3W3 | DAMMV3V3PN | DAMMZ3V3PN | DAMMN3V3PN |
| DA | 3WK3♣ | DAMMV3VK3PNTM | DAMMZ3VK3PNTM | DAMMN3VK3PNTM |
| DB | 5W5 | DBMMV5V5PN | DBMMZ5V5PN | DBMMN5V5PN |
| DB | 9W4 | DBMMV9V4PN | DBMMZ9V4PN | DBMMN9V4PN |
| DB | 13W3 | DBMMV13V3PN | DBMMZ13V3PN | DBMMN13V3PN |
| DB | 17W2 | DBMMV17V2PN | DBMMZ17V2PN | DBMMN17V2PN |
| DB | 21W1 | DBMMV21V1PN | DBMMZ21V1PN | DBMMN21V1PN |
| DC | 8W8 | DCMMV8V8PN | DCMMZ8V8PN | DCMMN8V8PN |
| DC | 13W6 | DCMMV13V6PN | DCMMZ13V6PN | DCMMN13V6PN |
| DC | 17W5 | DCMMV17V5PN | DCMMZ17V5PN | DCMMN17V5PN |
| DC | 21WA4 | DCMMV21VA4PN | DCMMZ21VA4PN | DCMMN21VA4PN |
| DC | 25W3 | DCMMV25V3PN | DCMMZ25V3PN | DCMMN25V3PN |
| DC | 27W2 | DCMMV27V2PN | DCMMZ27V2PN | DCMMN27V2PN |

Notes: For DD shell size, see page 164.

♣ Keyed.



Dimensions

| Plug Shell Size | A | B | C | D | E | F | W | W | L |
|-----------------|---------------|---------------|---------------|--------------|--------------|--------------|--------------|--------------|--------------|
| DE | ±0,38 (.015) | ±0,13 (.005) | ±0,13 (.005) | ±0,13 (.005) | ±0,38 (.015) | ±0,25 (.010) | ±0,37 (.015) | ±0,41 (.016) | ±0,25 (.010) |
| DA | 30,81 (1.213) | 16,92 (.666) | 24,99 (.984) | 8,36 (.329) | 12,55 (.494) | 10,72 (.422) | 6,69 (.264) | — | 0,76 (.030) |
| DB | 39,14 (1.541) | 25,25 (.994) | 33,32 (1.312) | 8,36 (.329) | 12,55 (.494) | 10,72 (.422) | 6,69 (.264) | — | 0,76 (.030) |
| DB | 53,04 (2.088) | 38,96 (1.534) | 47,04 (1.852) | 8,36 (.329) | 12,55 (.494) | 10,82 (.426) | — | 6,84 (.269) | 0,99 (.039) |
| DC | 69,32 (2.729) | 55,42 (2.182) | 63,50 (2.500) | 8,36 (.329) | 12,55 (.494) | 10,82 (.426) | — | 6,84 (.269) | 0,99 (.039) |

High Voltage Straight PCB (Sizes DE-DC)

Receptacle



Reader's Resource

- For contact cavity arrangements, see page 223.
- For P.C. hole patterns, see pages 257-258.
- For panel cutouts, see page 221.
- For hardware views (Standard), see page 226.

Part Numbers with Standoff #4-40 UNC

| Shell Size | Layout | Part Number Without Screw Locks Without Boardlocks | Part Number Without Screw Locks With Boardlocks | Part Number With Screw Locks With Boardlocks |
|------------|--------|--|---|--|
| DE | 5W1 | DEMMV5V1SN | DEMMZ5V1SN | DEMMN5V1SN |
| DA | 7W2 | DAMMV7V2SN | DAMMZ7V2SN | DAMMN7V2SN |
| DA | 11W1 | DAMMV11V1SN | DAMMZ11V1SN | DAMMN11V1SN |
| DA | 3W3 | DAMMV3V3SN | DAMMZ3V3SN | DAMMN3V3SN |
| DA | 3WK3♣ | DAMMV3VK3SNTM | DAMMZ3VK3SNTM | DAMMN3VK3SNTM |
| DB | 5W5 | DBMMV5V5SN | DBMMZ5V5SN | DBMMN5V5SN |
| DB | 9W4 | DBMMV9V4SN | DBMMZ9V4SN | DBMMN9V4SN |
| DB | 13W3 | DBMMV13V3SN | DBMMZ13V3SN | DBMMN13V3SN |
| DB | 17W2 | DBMMV17V2SN | DBMMZ17V2SN | DBMMN17V2SN |
| DB | 21W1 | DBMMV21V1SN | DBMMZ21V1SN | DBMMN21V1SN |
| DC | 8W8 | DCMMV8V8SN | DCMMZ8V8SN | DCMMN8V8SN |
| DC | 13W6 | DCMMV13V6SN | DCMMZ13V6SN | DCMMN13V6SN |
| DC | 17W5 | DCMMV17V5SN | DCMMZ17V5SN | DCMMN17V5SN |
| DC | 21WA4 | DCMMV21VA4SN | DCMMZ21VA4SN | DCMMN21VA4SN |
| DC | 25W3 | DCMMV25V3SN | DCMMZ25V3SN | DCMMN25V3SN |
| DC | 27W2 | DCMMV27V2SN | DCMMZ27V2SN | DCMMN27V2SN |

Notes: For DD shell size, see page 165.

♣ Keyed.



Dimensions

| Receptacle Shell Size | A | B | C | D | E | F | W | L |
|-----------------------|---------------|---------------|---------------|--------------|--------------|--------------|--------------|--------------|
| DE | ±0,38 (.015) | ±0,13 (.005) | ±0,13 (.005) | ±0,13 (.005) | ±0,38 (.015) | ±0,25 (.010) | ±0,38 (.015) | ±0,25 (.010) |
| DA | 30,81 (1.213) | 16,33 (.643) | 24,99 (.984) | 7,90 (.311) | 12,55 (.494) | 10,90 (.429) | 6,94 (.273) | 0,76 (.030) |
| DB | 39,14 (1.541) | 24,66 (.971) | 33,32 (1.312) | 7,90 (.311) | 12,55 (.494) | 10,90 (.429) | 6,94 (.273) | 0,76 (.030) |
| DB | 53,04 (2.088) | 38,38 (1.511) | 47,04 (1.852) | 7,90 (.311) | 12,55 (.494) | 10,90 (.429) | 6,94 (.273) | 0,76 (.030) |
| DC | 69,32 (2.729) | 54,84 (2.159) | 63,50 (2.500) | 7,90 (.311) | 12,55 (.494) | 10,90 (.429) | 6,94 (.273) | 0,76 (.030) |

High Voltage Straight PCB (Size DD)

Plug

Part Numbers with Standoff #4-40 UNC



| Shell Size | Layout | Part Number Without Screw Locks Without Boardlocks | Part Number Without Screw Locks With Boardlocks | Part Number With Screw Locks With Boardlocks |
|------------|--------|--|---|--|
| DD | 24W7 | DDMMV24V7PN | DDMMZ24V7PN | DDMMN24V7PN |
| DD | 36W4 | DDMMV36V4PN | DDMMZ36V4PN | DDMMN36V4PN |
| DD | 43W2 | DDMMV43V2PN | DDMMZ43V2PN | DDMMN43V2PN |
| DD | 47W1 | DDMMV47V1PN | DDMMZ47V1PN | DDMMN47V1PN |

Reader's Resource

- For contact cavity arrangements, see page 222.
- For P.C. hole patterns, see page 256.
- For panel cutouts, see page 221.
- For hardware views (Standard), see page 226.



Dimensions

| Plug Shell Size | A | B | C | D | E | F | W | L |
|-----------------|---------------|---------------|---------------|--------------|--------------|--------------|--------------|--------------|
| DD | ±0,38 (.015) | ±0,13 (.005) | ±0,13 (.005) | ±0,13 (.005) | ±0,38 (.015) | ±0,25 (.010) | ±0,41 (.016) | ±0,25 (.010) |
| | 66,93 (2.635) | 52,81 (2.079) | 61,11 (2.406) | 11,07 (.436) | 15,37 (.605) | 10,82 (.426) | 6,84 (.269) | 0,99 (.039) |

High Voltage Straight PCB (Size DD)

Receptacle



Part Numbers with Standoff #4-40 UNC

| Shell Size | Layout | Part Number Without Screw Locks Without Boardlocks | Part Number Without Screw Locks With Boardlocks | Part Number With Screw Locks With Boardlocks |
|------------|--------|--|---|--|
| DD | 24W7 | DDMMV24V7SN | DDMMZ24V7SN | DDMMN24V7SN |
| DD | 36W4 | DDMMV36V4SN | DDMMZ36V4SN | DDMMN36V4SN |
| DD | 43W2 | DDMMV43V2SN | DDMMZ43V2SN | DDMMN43V2SN |
| DD | 47W1 | DDMMV47V1SN | DDMMZ47V1SN | DDMMN47V1SN |

Reader's Resource

For contact cavity arrangements, see page 223.

For P.C. hole patterns, see page 259.

For panel cutouts, see page 221.

For hardware views (Standard), see page 226.



Dimensions

| Receptacle Shell Size | A | B | C | D | E | F | W | L |
|-----------------------|---------------|---------------|---------------|--------------|--------------|--------------|--------------|--------------|
| DD | ±0,38 (.015) | ±0,13 (.005) | ±0,13 (.005) | ±0,13 (.005) | ±0,38 (.015) | ±0,25 (.010) | ±0,38 (.015) | ±0,25 (.010) |
| DD | 66,93 (2.635) | 52,42 (2.064) | 61,11 (2.406) | 10,74 (.423) | 15,37 (.605) | 10,90 (.429) | 6,94 (.273) | 0,76 (.030) |

Cable Solder Cup

Plug



Reader's Resource

For contact cavity arrangements, see page 222.
 For panel cutouts, see page 221.
 For hardware views (Standard), see page 226.

Part Numbers

| Shell Size | Layout | Through Hole | Dual Float Mount | Clinch Nut #4-40 UNC |
|------------|--------|--------------|------------------|----------------------|
| DE | 5W1 | DEMM5W1P | DEMMY5W1P | DEMME5W1P |
| DA | 7W2 | DAMM7W2P | DAMMY7W2P | DAMME7W2P |
| DA | 11W1 | DAMM11W1P | DAMMY11W1P | DAMME11W1P |
| DA | 3W3 | DAMM3W3P | DAMMY3W3P | DAMME3W3P |
| DA | 3WK3♣ | DAMM3WK3P | DAMMY3WK3P | DAMME3WK3P |
| DB | 5W5 | DBMM5W5P | DBMMY5W5P | DBMME5W5P |
| DB | 9W4 | DBMM9W4P | DBMMY9W4P | DBMME9W4P |
| DB | 13W3 | DBMM13W3P | DBMMY13W3P | DBMME13W3P |
| DB | 17W2 | DBMM17W2P | DBMMY17W2P | DBMME17W2P |
| DB | 21W1 | DBMM21W1P | DBMMY21W1P | DBMME21W1P |
| DC | 8W8 | DCMM8W8P | DCMMY8W8P | DCMME8W8P |
| DC | 13W6 | DCMM13W6P | DCMMY13W6P | DCMME13W6P |
| DC | 17W5 | DCMM17W5P | DCMMY17W5P | DCMME17W5P |
| DC | 21WA4 | DCMM21WA4P | DCMMY21WA4P | DCMME21WA4P |
| DC | 25W3 | DCMM25W3P | DCMMY25W3P | DCMME25W3P |
| DC | 27W2 | DCMM27W2P | DCMMY27W2P | DCMME27W2P |
| DD | 24W7 | DDMM24W7P | DDMMY24W7P | DDMME24W7P |
| DD | 36W4 | DDMM36W4P | DDMMY36W4P | DDMME36W4P |
| DD | 43W2 | DDMM43W2P | DDMMY43W2P | DDMME43W2P |
| DD | 47W1 | DDMM47W1P | DDMMY47W1P | DDMME47W1P |

Note: ♣ Keyed.



DD Configuration



Dimensions

| Shell Size | A | B | C | D | E | F | W | W | K | K | L |
|------------|---------------|---------------|---------------|--------------|--------------|--------------|----------------|--------------|----------------|--------------|--------------|
| | ±0,38 (.015) | ±0,13 (.005) | ±0,13 (.005) | ±0,13 (.005) | ±0,38 (.015) | ±0,25 (.010) | ±0,368 (.0145) | ±0,41 (.016) | ±0,317 (.0125) | ±0,25 (.010) | ±0,25 (.010) |
| DE | 30,81 (1.213) | 16,92 (.666) | 24,99 (.984) | 8,36 (.329) | 12,55 (.494) | 10,72 (.422) | 6,693 (.2635) | — | 1,206 (.0475) | — | 0,76 (.030) |
| DA | 39,14 (1.541) | 25,25 (.994) | 33,32 (1.312) | 8,36 (.329) | 12,55 (.494) | 10,72 (.422) | 6,693 (.2635) | — | 1,206 (.0475) | — | 0,76 (.030) |
| DB | 53,04 (2.088) | 38,96 (1.534) | 47,04 (1.852) | 8,36 (.329) | 12,55 (.494) | 10,82 (.426) | — | 6,84 (.269) | — | 1,52 (.060) | 0,99 (.039) |
| DC | 69,32 (2.729) | 55,42 (2.182) | 63,50 (2.500) | 8,36 (.329) | 12,55 (.494) | 10,82 (.426) | — | 6,84 (.269) | — | 1,52 (.060) | 0,99 (.039) |
| DD | 66,93 (2.635) | 52,81 (2.079) | 61,11 (2.406) | 11,07 (.436) | 15,37 (.605) | 10,82 (.426) | — | 6,84 (.269) | — | 1,52 (.060) | 0,99 (.039) |

Cable Solder Cup

Receptacle



Part Numbers

| Shell Size | Layout | Through Hole | Dual Float Mount | Clinch Nut #4-40 UNC |
|------------|--------|--------------|------------------|----------------------|
| DE | 5W1 | DEM5W1S | DEMMY5W1S | DEMME5W1S |
| DA | 7W2 | DAMM7W2S | DAMMY7W2S | DAMME7W2S |
| DA | 11W1 | DAMM11W1S | DAMMY11W1S | DAMME11W1S |
| DA | 3W3 | DAMM3W3S | DAMMY3W3S | DAMME3W3S |
| DA | 3WK3♣ | DAMM3WK3S | DAMMY3WK3S | DAMME3WK3S |
| DB | 5W5 | DBMM5W5S | DBMMY5W5S | DBMME5W5S |
| DB | 9W4 | DBMM9W4S | DBMMY9W4S | DBMME9W4S |
| DB | 13W3 | DBMM13W3S | DBMMY13W3S | DBMME13W3S |
| DB | 17W2 | DBMM17W2S | DBMMY17W2S | DBMME17W2S |
| DB | 21W1 | DBMM21W1S | DBMMY21W1S | DBMME21W1S |
| DC | 8W8 | DCMM8W8S | DCMMY8W8S | DCMME8W8S |
| DC | 13W6 | DCMM13W6S | DCMMY13W6S | DCMME13W6S |
| DC | 17W5 | DCMM17W5S | DCMMY17W5S | DCMME17W5S |
| DC | 21WA4 | DCMM21WA4S | DCMMY21WA4S | DCMME21WA4S |
| DC | 25W3 | DCMM25W3S | DCMMY25W3S | DCMME25W3S |
| DC | 27W2 | DCMM27W2S | DCMMY27W2S | DCMME27W2S |
| DD | 24W7 | DCMM24W7S | DCMMY24W7S | DCMME24W7S |
| DD | 36W4 | DCMM36W4S | DCMMY36W4S | DCMME36W4S |
| DD | 43W2 | DCMM43W2S | DCMMY43W2S | DCMME43W2S |
| DD | 47W1 | DCMM47W1S | DCMMY47W1S | DCMME47W1S |

Reader's Resource

For contact cavity arrangements, see page 223.
 For panel cutouts, see page 221.
 For hardware views (Standard), see page 226.

Note: ♣ Keyed.

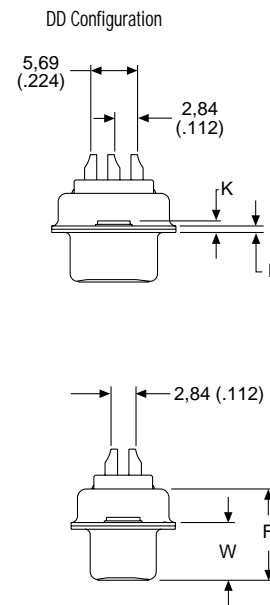

Dimensions

| Shell Size | A ±0,38 (.015) | B ±0,13 (.005) | C ±0,13 (.005) | D ±0,13 (.005) | E ±0,38 (.015) | F ±0,25 (.010) | W ±0,38 (.015) | K ±0,318 (.0125) | L ±0,25 (.010) |
|------------|-------------------|-------------------|-------------------|-------------------|-------------------|-------------------|-------------------|---------------------|-------------------|
| DE | 30,81 (1.123) | 16,33 (.643) | 24,99 (.984) | 7,90 (.311) | 12,55 (.494) | 10,90 (.429) | 6,94 (.273) | 1,206 (.0475) | 0,76 (.030) |
| DA | 39,14 (1.541) | 24,66 (.971) | 33,32 (1.312) | 7,90 (.311) | 12,55 (.494) | 10,90 (.429) | 6,94 (.273) | 1,206 (.0475) | 0,76 (.030) |
| DB | 53,04 (2.088) | 38,38 (1.511) | 47,04 (1.852) | 7,90 (.311) | 12,55 (.494) | 10,90 (.429) | 6,94 (.273) | 1,206 (.0475) | 0,76 (.030) |
| DC | 69,32 (2.729) | 54,84 (2.159) | 63,50 (2.500) | 7,90 (.311) | 12,55 (.494) | 10,90 (.429) | 6,94 (.273) | 1,206 (.0475) | 0,76 (.030) |
| DD | 66,93 (2.635) | 52,42 (2.064) | 61,11 (2.406) | 10,74 (.423) | 15,37 (.605) | 10,90 (.429) | 6,94 (.273) | 1,206 (.0475) | 0,76 (.030) |

ITT Cannon has a long history of providing high performance D Subminiature connectors for space applications (qualified by NASA/GFSC and the European Space Agency). Space/High Reliability D*M and D*MA connectors meet stringent tests for outgassing and residual magnetism and are suitable for use in space, medical, and high performance military/aerospace applications. D*M and D*MA connectors are designed to be comparable to MIL-C-24308. The newest product group is High Density D*MA crimp connectors.

Applications

- Space - Low/High Orbit Satellites
- Medical



Product Features

Non-Magnetic

No Outgassing

Specifications

| | |
|-------------------------------|---|
| Temperature Rating | -65° at 125°C |
| Signal Contact Current Rating | 5 A (20 AWG) |
| Signal Contact Resistance | 55 millivolt max. at 7.5 A test current |
| Wire Accommodation (Solder) | 20 AWG max. |
| Wire Accommodation (Crimp) | 18/30 AWG |
| Coaxial Impedance | 50 Ohm |
| Loss VSWR | Less than 1,3 - 1,0 up to 500 Mhz |
| Coaxial Insertion Loss | 1db loss at 500 Mhz |

Dielectric Withstanding Voltage

| | | Altitude (meter/feet) | | | | | | | |
|--|----------------|-----------------------|-----------|--------------|--------------|---------------|---------------|---------------|---------------|
| | | Sea Level | Sea Level | 6 096/20 000 | 6 096/20 000 | 15 240/50 000 | 15 240/50 000 | 21 336/70 000 | 21 336/70 000 |
| Average Flashover | | 1500/1700 | 1500/1700 | 1000/1000 | 1000/1000 | 500/650 | 500/650 | 500/500 | 500/500 |
| Test | | 1000/1250 | 1000/1250 | 650/750 | 650/750 | 325/475 | 325/475 | 325/375 | 325/375 |
| Type of Contact | | 90° | Straight | 90° | Straight | 90° | Straight | 90° | Straight |
| Center Conductor to Coaxial Shell | Average | 1200 | 1500 | 900 | 1000 | 600 | 700 | 400 | 500 |
| | Flashover Test | 800 | 1000 | 600 | 550 | 400 | 475 | 275 | 325 |
| Coaxial Shell to Nearest Solder Cup Contact | Average | — | 1500 | — | 1500 | — | 900 | — | 650 |
| | Flashover Test | — | 1000 | — | 1000 | — | 800 | — | 425 |
| High Power Contact and/or Coaxial Shell to Plug Shell | Average | 1500 | 1500 | 1000 | 1000 | 500 | 500 | 500 | 500 |
| | Flashover Test | 1000 | 1000 | 650 | 650 | 325 | 325 | 325 | 325 |
| Size 20 Signal Contact | Average | 1200 | 1200 | 1000 | 1000 | 650 | 650 | 500 | 500 |
| | Flashover Test | 1250 | 1250 | 750 | 750 | 475 | 475 | 375 | 375 |

All voltage figures are rms AC 60 rms cps. Measured at approximately +25°C, 50% rh. For additional performance specifications refer to 24308-Style.

Residual Magnetism Level

| Residual Magnetism | Suffix Code |
|--------------------|-------------|
| 20 000 Gamma | NM |
| 200 Gamma | NMB |

Note: NMC is available by special request. Consult factory for details.

NASA/GSFC Cross Reference

| NASA/GSFC Part Number | ITT Cannon Part Number | NASA/GSFC Part Number | ITT Cannon Part Number | NASA/GSFC Part Number | ITT Cannon Part Number |
|-----------------------|------------------------|-----------------------|------------------------|-----------------------|------------------------|
| G08P1 | 030-2042-002 | 311-P-10-12S-B-15 | DBM13W3S-NMB-76 | 311-P-10-24P-B-12 | DDM43W2P-NMB-77 |
| G08S1 | 031-1147-002 | 311-P-10-12S-C-15 | DBM-13W3S-NMC-76 | 311-P-10-24S-C-12 | DDM-43W2S-NMB-77 |
| S-311-P-4/6GCP1 | DM53740-17 | 311-P-10-13P-B-12 | DBM17W2PNMB77 | 311-P-10-24S-C-15 | DDM-43W2S-NMC-76 |
| S-311-P-4/6GCP2 | DM53740-15 | 311-P-10-13P-B-15 | DBM-17W2P-NMB-76 | 311-P-10-25P-C-15 | DDM47W1P-NMC-76 |
| S-311-P-4/6GCP3 | DM53740-16 | 311-P-10-13P-C-12 | DBM17W2P-NMC-77 | 311-P-10-25S-C-15 | DDM-47W1S-NMC-76 |
| S-311-P-4/6GCP4 | DM53740-18 | 311-P-10-13P-C-15 | DBM-17W2P-NMC-76 | 311-P-10-3S-B-12 | DBM25PNMB77 |
| S-311-P-4/6GCRP1 | DM53741-12 | 311-P-10-13S-B-12 | DBM17W2SNMB77 | 311-P-10-3P-B-15 | DBM25PNMB76 |
| S-311-P-4/6GCRP2 | DM53741-11 | 311-P-10-13S-C-12 | DBM-17W2S-NMC-77 | 311-P-10-3P-C-12 | DBM25PNMC77 |
| S-311-P-4/6GCRP3 | DM53741-10 | 311-P-10-13S-C-15 | DBM-17W2S-NMC-76 | 311-P-10-3P-C-15 | DBM25PNMC76 |
| S-311-P-4/6GCRP4 | DM53741-13 | 311-P-10-14P-B-12 | DBM-21W1P-NMB-77 | 311-P-10-3S-B-12 | DBM25PNMB77 |
| S-311-P-4/6GCRS1 | DM53743-18 | 311-P-10-14P-B-15 | DBM-21W1P-NMB-76 | 311-P-10-3S-B-15 | DBM-25S-NMB-76 |
| S-311-P-4/6GCRS2 | DM53743-16 | 311-P-10-14S-B-12 | DBM-21W1S-NMB-77 | 311-P-10-3S-C-12 | DBM-25S-NMC-77 |
| S-311-P-4/6GCRS3 | DM53743-17 | 311-P-10-14S-B-15 | DBM-21W1S-NMB-76 | 311-P-10-3S-C-15 | DBM-25S-NMC-76 |
| S-311-P-4/6GCRS4 | DM53743-19 | 311-P-10-14S-C-15 | DBM-21W1S-NMC-76 | 311-P-10-4P-B-12 | DCM37PNMB77 |
| S-311-P-4/6GCS1 | DM53742-18 | 311-P-10-15P-B-12 | DCM-8W8P-NMB-77 | 311-P-10-4P-B-15 | DCM37PNMB76 |
| S-311-P-4/6GCS2 | DM53742-16 | 311-P-10-15P-B-15 | DCM8W8PNMB76 | 311-P-10-4P-C-12 | DCM-37P-NMC-77 |
| S-311-P-4/6GCS3 | DM53742-17 | 311-P-10-15P-C-12 | DCM-8W8P-NMC-77 | 311-P-10-4P-C-15 | DCM37PNMC76 |
| S-311-P-4/6GCS4 | DM53742-19 | 311-P-10-15P-C-15 | DCM8W8PNMC76 | 311-P-10-4S-B-12 | DCM37SNMB77 |
| S-311-P-4/6GHP6 | DM51157-8 | 311-P-10-15S-B-12 | DCM-8W8S-NMB-77 | 311-P-10-4S-B-15 | DCM-37S-NMB-76 |
| S-311-P-4/6GHRP6 | DM51157-5005 | 311-P-10-15S-B-15 | DCM8W8SNMB76 | 311-P-10-4S-C-12 | DCM-37S-NMC-77 |
| S-311-P-4/6GHRP6 | DM51155-5005 | 311-P-10-15S-C-12 | DCM-8W8S-NMC-77 | 311-P-10-4S-C-15 | DCM-37S-NMC-76 |
| S-311-P-4/6GHS6 | DM51155-7 | 311-P-10-15S-C-15 | DCM-8W8S-MNC-76 | 311-P-10-5P-B-12 | DDM50PNMB77 |
| 311P409-1P-B-12 | DEMA9PNMBK47FO | 311-P-10-16P-B-12 | DCM-13W6P-NMB-77 | 311-P-10-5P-B-15 | DDM50PNMB76 |
| 311P409-1P-B-15 | DEMAK9PNMBK47FO | 311-P-10-16P-B-15 | DCM-13W6P-NMB-76 | 311-P-10-5P-C-12 | DDM-50P-NMC-77 |
| 311P409-1S-B-12 | DEMA9SNMBK47FO | 311-P-10-16P-C-12 | DCM-13W6P-NMC-77 | 311-P-10-5P-C-15 | DDM50PNMC76 |
| 311P409-1S-B-15 | DEMAK9SNMBK47FO | 311-P-10-16P-C-15 | DCM-13W6P-NMC-76 | 311-P-10-5S-B-12 | DDM50SNMB77 |
| 311P409-2P-B-12 | DEMA15PNMBK47FO | 311-P-10-16S-B-12 | DCM-13W6S-NMB-77 | 311-P-10-5S-B-15 | DDM50SNMB76 |
| 311P409-2P-B-15 | DEMAK15PNMBK47FO | 311-P-10-16S-C-12 | DCM-13W6S-NMC-77 | 311-P-10-5S-C-12 | DDM-50S-NMC-77 |
| 311P409-2S-B-12 | DEMA15SNMBK47FO | 311-P-10-16S-C-15 | DCM13W6SNMC76 | 311-P-10-5S-C-15 | DDM-50S-NMC-76 |
| 311P409-2S-B-15 | DEMAK15SNMBK47FO | 311-P-10-17P-B-12 | DCM17W5PNMB77 | 311-P-10-6P-B-12 | DEM-5W1P-NMB-77 |
| 311P409-3P-B-12 | DEMA25PNMBK47FO | 311-P-10-17P-B-15 | DCM-17W5P-NMB-76 | 311-P-10-6P-B-15 | DEM-5W1P-NMB-76 |
| 311P409-3P-B-15 | DEMAK25PNMBK47FO | 311-P-10-17P-C-12 | DCM-17W5P-NMC-77 | 311-P-10-6P-C-15 | DEM-5W1P-NMC-76 |
| 311P409-3S-B-12 | DEMA25SNMBK47FO | 311-P-10-17P-C-15 | DCM-17W5P-NMC-76 | 311-P-10-6S-B-12 | DEM-5W1S-NMB-77 |
| 311P409-3S-B-15 | DEMAK25SNMBK47FO | 311-P-10-17S-B-12 | DCM-17W5S-NMB-77 | 311-P-10-6S-B-15 | DEM-5W1S-NMB-76 |
| 311P409-4P-B-12 | DEMA37PNMBK47FO | 311-P-10-17S-B-15 | DCM17W5S-NMB-76 | 311-P-10-7P-B-12 | DAM3W3PNMC76 |
| 311P409-4P-B-15 | DEMAK37PNMBK47FO | 311-P-10-17S-C-12 | DCM-17W5S-NMC-77 | 311-P-10-7P-B-15 | DAM-3W3P-NMB-76 |
| 311P409-4S-B-12 | DEMA37SNMBK47FO | 311-P-10-17S-C-15 | DCM-17W5S-NMC-76 | 311-P-10-7P-C-12 | DAM3W3P-NMC-77 |
| 311P409-4S-B-15 | DEMAK37SNMBK47FO | 311-P-10-18P-B-12 | DCM-21WA4P-NMB-77 | 311-P-10-7P-C-15 | DAM-3W3P-NMC-76 |
| 311P409-5P-B-12 | DEMA50PNMBK47FO | 311-P-10-18P-B-15 | DCM21WA4P-NMB-76 | 311-P-10-7S-B-12 | DAM3W3SNMB77 |
| 311P409-5S-B-12 | DEMAK50PNMBK47FO | 311-P-10-18P-C-15 | DCM-21WA4P-NMC-76 | 311-P-10-7S-B-15 | DAM3W3SNMB76 |
| 311P409-5S-B-15 | DEMA50SNMBK47FO | 311-P-10-18S-B-12 | DCM-21WA4S-NMB-77 | 311-P-10-7S-C-12 | DAM3W3S-NMC-76 |
| 311P409-5S-B-15 | DEMAK50PNMBK47FO | 311-P-10-18S-B-15 | DCM21WA4S-NMB-76 | 311-P-10-7S-C-15 | DAM-3W3S-NMC-76 |
| S-311-P-4/10G10P1 | 330-5291-081-02 | 311-P-10-19P-B-12 | DCM-21W4P-NMB-77 | 311-P-10-8P-B-12 | DAM-7W2P-NMB-77 |
| S-311-P-4/10G10S1 | 031-1007-052-05 | 311-P-10-19S-B-12 | DCM-21W4S-NMB-77 | 311-P-10-8P-B-15 | DAM-7W2P-NMB-76 |
| 311-P-10-B-1S-B-15 | DEMB9S-NMB-76 | 311-P-10-19S-C-15 | DCM21W4S-NMC-76 | 311-P-10-8P-C-15 | DAM-7W2P-NMC-76 |
| 311-P-10-B-4S-B-15 | DCMB37S-NMB-76 | 311-P-10-2P-B-12 | DAM15PNMB77 | 311-P-10-8S-B-12 | DAM-7W2S-NMB-77 |
| 311-P-10-1P-B-12 | DEMPNNMB77 | 311-P-10-2P-B-15 | DAM15PNMB76 | 311-P-10-8P-C-12 | DAM7W2S-NMC-77 |
| 311-P-10-1P-B-15 | DEM-9P-NMB-76 | 311-P-10-2P-C-12 | DAM15PNMC77 | 311-P-10-8P-C-15 | DAM-7W2S-NMC-76 |
| 311-P-10-1P-C-12 | DEM9PNMC77 | 311-P-10-2P-C-15 | DAM15PNMC76 | 311-P-10-9P-B-12 | DAM-11W1P-NMB-77 |
| 311-P-10-1P-C-15 | DEM9PNMC76 | 311-P-10-2S-B-12 | DAM15SNMB77 | 311-P-10-9P-B-15 | DAM-11W1P-NMB-76 |
| 311-P-10-1S-B-12 | DEM9SNMB77 | 311-P-10-2S-B-15 | DAM-15S-NMB-76 | 311-P-10-9P-C-12 | DAM-11W1P-NMC-77 |
| 311-P-10-1S-B-15 | DEM-9S-NMB-76 | 311-P-10-2S-C-15 | DAM-15S-NMC-76 | 311-P-10-9P-C-15 | DAM-11W1P-NMC-76 |
| 311-P-10-1S-C-12 | DEM-9S-NMC-77 | 311-P-10-2S-C-15 | DAM-15S-NMC-76 | 311-P-10-9S-B-12 | DAM-11W1S-NMB-77 |
| 311-P-10-1S-C-15 | DEM9SNMC76 | 311-P-10-20P-B-12 | DCM-25W3P-NMB-77 | 311-P-10-9S-B-15 | DAM-11W1S-NMB-76 |
| 311-P-10-10P-B-12 | DBM5W5PNMB77 | 311-P-10-20P-C-15 | DCM25W3P-NMB-76 | 311-P-10-9S-C-12 | DAM-11W1S-NMC-77 |
| 311-P-10-10P-B-15 | DBM-5W5P-NMB-76 | 311-P-10-20S-B-12 | DCM-25W36-NMB-77 | 311-P-10-9S-C-15 | DAM-11W1S-NMC-76 |
| 311-P-10-10P-C-12 | DBM-5W5P-NMC-77 | 311-P-10-20S-C-12 | DCM-25W3S-NMC-77 | 311-P-10B-1S-B-12 | DEMB9SNMB77 |
| 311-P-10-10P-C-15 | DBM-5W5P-NMC-76 | 311-P-10-20S-C-15 | DCM-25W3S-NMC-76 | 311-P-10B-1S-C-12 | DEMB-9S-NMC-77 |
| 311-P-10-10S-B-12 | DBM-5W5S-NMB-77 | 311-P-10-21P-C-15 | DCM27W2P-NMC-76 | 311-P-10B-1S-C-15 | DEMB9S-NMC-76 |
| 311-P-10-10S-B-15 | DBM-5W5S-NMB-76 | 311-P-10-21S-C-15 | DCM-27W2S-NMC-76 | 311-P-10B-13S-B-15 | DBMB-17W2S-NMB-76 |
| 311-P-10-10S-C-12 | DBM-5W5S-NMC-77 | 311-P-10-22P-B-12 | DDM-24W7P-NMB-77 | 311-P-10B-17S-B-15 | DCMB-17W5S-NMB-76 |
| 311-P-10-10S-C-15 | DBM-5W5S-NMC-76 | 311-P-10-22P-B-15 | DDM24W7PNMB76 | 311-P-10B-2S-B-12 | DAMB15SNMB77 |
| 311-P-10-11P-B-12 | DBM-9W4P-NMB-77 | 311-P-10-22P-C-15 | DDM-24W7P-NMC-76 | 311-P-10B-2S-C-12 | DAMB-15S-NMC-77 |
| 311-P-10-11P-C-15 | DBM-9W4P-NMC-76 | 311-P-10-22S-B-12 | DDM24W7SNMB77 | 311-P-10B-2S-C-15 | DAMB15SNMC76 |
| 311-P-10-11S-B-12 | DBM-9W4S-NMB-77 | 311-P-10-22S-B-15 | DDM-24W7S-NMB-76 | 311-P-10B-22S-B-15 | DDMB-247S-NMB-76 |
| 311-P-10-11S-C-15 | DBM-9W4S-NMC-76 | 311-P-10-22S-C-15 | DDM-24W7S-NMC-76 | 311-P-10B-3S-B-12 | DBMB-25S-NMB-77 |
| 311-P-10-12P-B-12 | DBM13W3P-NMB-77 | 311-P-10-23P-B-12 | DDM-36W4P-NMB-77 | 311-P-10B-3S-B-15 | DBMB-25S-NMB-76 |
| 311-P-10-12P-B-15 | DBM-13W3P-NMB-76 | 311-P-10-23S-B-12 | DDM-36W4S-NMB-77 | 311-P-10B-3S-C-12 | DBMB-25S-NMC-77 |
| 311-P-10-12P-C-15 | DBM-13W3P-NMC-76 | 311-P-10-23S-B-15 | DDM36W4SNMB76 | 311-P-10B-3S-C-15 | DBMB25SNMC76 |
| 311-P-10-12S-B-12 | DBM-13W3S-NMB-77 | 311-P-10-23S-C-15 | DDM-36W4S-NMC-76 | 311-P-10B-4S-B-12 | DCMB-37S-NMB-77 |

NASA/GSFC Cross Reference

Table with 6 columns: NASA/GSFC Part Number, ITT Cannon Part Number, NASA/GSFC Part Number, ITT Cannon Part Number, NASA/GSFC Part Number, ITT Cannon Part Number. Lists cross-references for various part numbers.

ESA/SCC Cross Reference

Large table with 6 columns: ESA-SCC Part Number, ITT Cannon Part Number, ESA-SCC Part Number, ITT Cannon Part Number, ESA-SCC Part Number, ITT Cannon Part Number. Contains extensive cross-reference data for ESA/SCC parts.

ESA/SCC Cross Reference

| ESA-SCC Part Number | ITT Cannon Part Number | ESA-SCC Part Number | ITT Cannon Part Number | ESA-SCC Part Number | ITT Cannon Part Number |
|------------------------------|------------------------|---------------------------|------------------------|---------------------|------------------------|
| 340100101B DDM36W4SF179ANMB | DDM36W4SF179ANMBK52 | 340100101B DAM15S1A9NNMB | DAM15S1A9NNMBK52 | 340100415B | DM115740-13 |
| 340100101B DDM43W2SF179ANMB | DDM43W2SF179ANMBK52 | 340100101B DBM25S1A9NNMB | DBM25S1A9NNMBK52 | 340100419B | DM115740-12 |
| 340100101B DDM47W1SF179ANMB | DDM47W1SF179ANMBK52 | 340100101B DCM37S1A9NNMB | DCM37S1A9NNMBK52 | 340100412B | DM115742-15 |
| 340100101B DEM5W1PF179ANMB | DEM5W1PF179ANMBK52 | 340100101B DDM50S1A9NNMB | DDM50S1A9NNMBK52 | 340100416B | DM115742-14 |
| 340100101B DAM7W2PF179ANMB | DAM7W2PF179ANMBK52 | 340100101B DEM9P1A9NNMB | DEM9P1A9NNMBK52 | 340100420B | DM115742-13 |
| 340100101B DAM11W1PF179ANMB | DAM11W1PF179ANMBK52 | 340100101B DAM15P1A9NNMB | DAM15P1A9NNMBK52 | 340100413B | DM115741-7 |
| 340100101B DBM9W4PF179ANMB | DBM9W4PF179ANMBK52 | 340100101B DBM25P1A9NNMB | DBM25P1A9NNMBK52 | 340100417B | DM115741-8 |
| 340100101B DBM13W3PF179ANMB | DBM13W3PF179ANMBK52 | 340100101B DCM37P1A9NNMB | DCM37P1A9NNMBK52 | 340100414B | DM115743-20 |
| 340100101B DBM17W2PF179ANMB | DBM17W2PF179ANMBK52 | 340100101B DDM50P1A9NNMB | DDM50P1A9NNMBK52 | 340100418B | DM115743-22 |
| 340100101B DBM21W1PF179ANMB | DBM21W1PF179ANMBK52 | 340100101B DEM9SF179ANMB | DEM9SF179ANMBK52 | 340102207B | DE-59-20 |
| 340100101B DCM13W6PF179ANMB | DCM13W6PF179ANMBK52 | 340100101B DAM15SF179ANMB | DAM15SF179ANMBK52 | 340102208B | DE-60-20 |
| 340100101B DCM17W5PF179ANMB | DCM17W5PF179ANMBK52 | 340100101B DBM25SF179ANMB | DBM25SF179ANMBK52 | 340102209B | DA-59-20 |
| 340100101B DCM21WA4PF179ANMB | DCM21WA4PF179ANMBK52 | 340100101B DCM37SF179ANMB | DCM37SF179ANMBK52 | 340102210B | DA-60-20 |
| 340100101B DCM25W3PF179ANMB | DCM25W3PF179ANMBK52 | 340100101B DDM50SF179ANMB | DDM50SF179ANMBK52 | 340102211B | DB-59-20 |
| 340100101B DCM27W2PF179ANMB | DCM27W2PF179ANMBK52 | 340100101B DEM9PF179ANMB | DEM9PF179ANMBK52 | 340102212B | DB-60-20 |
| 340100101B DDM24W7PF179ANMB | DDM24W7PF179ANMBK52 | 340100101B DAM15PF179ANMB | DAM15PF179ANMBK52 | 340102213B | DC-59-20 |
| 340100101B DDM36W4PF179ANMB | DDM36W4PF179ANMBK52 | 340100101B DBM25PF179ANMB | DBM25PF179ANMBK52 | 340102214B | DC-60-20 |
| 340100101B DDM43W2PF179ANMB | DDM43W2PF179ANMBK52 | 340100101B DCM37PF179ANMB | DCM37PF179ANMBK52 | 340102215B | DD-59-20 |
| 340100101B DDM47W1PF179ANMB | DDM47W1PF179ANMBK52 | 340100101B DDM50PF179ANMB | DDM50PF179ANMBK52 | 340102216B | DD-60-20 |
| 340100101B DEM9SNMB | DEM9SNMBK52 | 340100102B DEMA9SNMB | DEMA9SNMBK52 | 340102201B | D20418-52 |
| 340100101B DAM15SNMB | DAM15SNMBK52 | 340100102B DAMA15SNMB | DAMA15SNMBK52 | 340102206B | D115418-70 |
| 340100101B DBM25SNMB | DBM25SNMBK52 | 340100102B DBMA25SNMB | DBMA25SNMBK52 | 340102258B | D20418-101 |
| 340100101B DCM37SNMB | DCM37SNMBK52 | 340100102B DCMA37SNMB | DCMA37SNMBK52 | 340102202B | D20419-74 |
| 340100101B DDM50SNMB | DDM50SNMBK52 | 340100102B DDMA50SNMB | DDMA50SNMBK52 | 340102203B | D20419-48 |
| 340100101B DEM9PNMB | DEM9PNMBK52 | 340100102B DEMA9PNMB | DEMA9PNMBK52 | 340102204B | D20420-67 |
| 340100101B DAM15PNMB | DAM15PNMBK52 | 340100102B DAMA15PNMB | DAMA15PNMBK52 | 340102205B | D20420-49 |
| 340100101B DBM25PNMB | DBM25PNMBK52 | 340100102B DBMA25PNMB | DBMA25PNMBK52 | 340102244B | D20419-73 |
| 340100101B DCM37PNMB | DCM37PNMBK52 | 340100102B DCMA37PNMB | DCMA37PNMBK52 | 340102245B | D20419-84 |
| 340100101B DDM50PNMB | DDM50PNMBK52 | 340100102B DDMA50PNMB | DDMA50PNMBK52 | 340102246B | D20420-63 |
| 340100101B DEM9SOL3NMB | DEM9SOL3NMBK52 | 340102217B | DA19678-174 | 340102247B | D20420-88 |
| 340100101B DAM15SOL3NMB | DAM15SOL3NMBK52 | 340102218B | DB19678-175 | 340102225B | DA19678-167 |
| 340100101B DBM25SOL3NMB | DBM25SOL3NMBK52 | 340102219B | DC19678-173 | 340102226B | DB19678-168 |
| 340100101B DCM37SOL3NMB | DCM37SOL3NMBK52 | 340102220B | DD19678-176 | 340102227B | DC19678-138 |
| 340100101B DDM50SOL3NMB | DDM50SOL3NMBK52 | 340102221B | DA19678-157 | 340102228B | DD19678-161 |
| 340100101B DEM9POL3NMB | DEM9POL3NMBK52 | 340102222B | DB19678-171 | 340102239B | DE19977-47 |
| 340100101B DAM15POL3NMB | DAM15POL3NMBK52 | 340102223B | DC19678-162 | 340102240B | DA19977-40 |
| 340100101B DBM25POL3NMB | DBM25POL3NMBK52 | 340102224B | DD19678-172 | 340102241B | DB19977-43 |
| 340100101B DCM37POL3NMB | DCM37POL3NMBK52 | 340104001B | DM115224-1040A | 340102242B | DC19977-45 |
| 340100101B DDM50POL3NMB | DDM50POL3NMBK52 | 340104003B | DM115224-1020A | 340102243B | DD19977-44 |
| 340100101B DEM9S1A0NNMB | DEM9S1A0NNMBK52 | 340104005B | DM115224-1010A | 340102234B | DE24657-16 |
| 340100101B DAM15S1A0NNMB | DAM15S1A0NNMBK52 | 340104002B | DM115224-2040A | 340102235B | DA24658-15 |
| 340100101B DBM25S1A0NNMB | DBM25S1A0NNMBK52 | 340104004B | DM115224-2020A | 340102236B | DB24659-15 |
| 340100101B DCM37S1A0NNMB | DCM37S1A0NNMBK52 | 340104006B | DM115224-2010A | 340102237B | DC24660-16 |
| 340100101B DDM50S1A0NNMB | DDM50S1A0NNMBK52 | 340104007B | DM115224-3040A | 340102238B | DD24661-13 |
| 340100101B DEM9P1A0NNMB | DEM9P1A0NNMBK52 | 340104008B | DM115224-4040A | 340102229B | DE115386-101A |
| 340100101B DAM15P1A0NNMB | DAM15P1A0NNMBK52 | 340104009B | DM115224-3020A | 340102230B | DA115386-104A |
| 340100101B DBM25P1A0NNMB | DBM25P1A0NNMBK52 | 340104010B | DM115224-4020A | 340102231B | DB115386-102A |
| 340100101B DCM37P1A0NNMB | DCM37P1A0NNMBK52 | 340104011B | DM115224-3010A | 340102232B | DC115386-100A |
| 340100101B DDM50P1A0NNMB | DDM50P1A0NNMBK52 | 340104012B | DM115224-4010A | 340102233B | DD115386-103A |
| 340100101B DEM9S1A7NNMB | DEM9S1A7NNMBK52 | 340100401B | DM115740-5036 | 340100501B | 030-8882-002 |
| 340100101B DAM15S1A7NNMB | DAM15S1A7NNMBK52 | 340100405B | DM115740-5046 | 340100502B | 031-8944-000 |
| 340100101B DBM25S1A7NNMB | DBM25S1A7NNMBK52 | 340100409B | DM115740-5047 | 340100503B | 030-8848-020 |
| 340100101B DCM37S1A7NNMB | DCM37S1A7NNMBK52 | 340100402B | DM115742-5028 | 340100504B | 031-8787-020 |
| 340100101B DDM50S1A7NNMB | DDM50S1A7NNMBK52 | 340100406B | DM115742-5039 | 340100505B | 330-8782-001 |
| 340100101B DEM9P1A7NNMB | DEM9P1A7NNMBK52 | 340100410B | DM115742-5075 | 340100506B | 031-8843-001 |
| 340100101B DAM15P1A7NNMB | DAM15P1A7NNMBK52 | 340100403B | DM115741-5048 | 340100507B | 330-8944-000 |
| 340100101B DBM25P1A7NNMB | DBM25P1A7NNMBK52 | 340100407B | DM115741-5032 | 340100508B | 031-8902-000 |
| 340100101B DCM37P1A7NNMB | DCM37P1A7NNMBK52 | 340100404B | DM115743-5064 | | |
| 340100101B DDM50P1A7NNMB | DDM50P1A7NNMBK52 | 340100408B | DM115743-5040 | | |
| 340100101B DEM9S1A9NNMB | DEM9S1A9NNMBK52 | 340100411B | DM115740-19 | | |

Selection Guide

| Locking Hardware | | | | | | | |
|------------------|--|-----------------------------------|---------------------------------|---|---------------------------------|------------------------------------|------------------------------|
| Backshell | Style | Female Screw Lock see page 209 | Male Screw Lock see page 208 | Sliding Lock Retainer Assembly see page 210 | Slide Lock Post see page 211 | Spring Latch Plate see page 212 | Spring Latch see page 212 |
| EMI Shielded | Snap-Together Metalized Plastic Straight Exit see page 200 | — | — | — | — | — | — |
| EMI Shielded | Snap-Together Metalized Plastic 40° Exit see page 200 | — | — | — | — | — | — |
| EMI Shielded | Die Cast Zinc Metal see page 202 | — | ▲ | — | — | — | — |
| Metal | Deep Straight Clamp see page 203 | ● | ● | ● | ● | ● | ● |
| Metal | Round Cable Clamp see page 203 | ● | ● | ● | ● | ● | ● |
| Metal | Short Straight Clamp see page 204 | ● | ● | ● | ● | ● | ● |
| Metal | 90° Entry see page 204 | ● | ● | ● | ● | ● | ● |
| Plastic | Snap-Together Universal see page 205 | ● | ● | — | — | — | — |
| Plastic | One-Piece Snap-Together see page 205 | — | ▲ | — | — | — | — |
| Plastic | One-Piece Plastic Straight Exit see page 206 | — | — | ● | ● | ● | ● |
| Plastic | One-Piece Plastic 90° Exit see page 206 | — | — | ● | ● | ● | ● |
| Plastic | Dataphone see page 206 | — | ▲ | — | — | — | — |
| Plastic | Quick Disconnect for IDC Cable see page 207 | — | — | — | — | — | — |
| Plastic | Quick Disconnect for Round Cable — Straight and 90° Exit see page 207 | — | — | — | — | — | — |

- ▲ Supplied with backshell
- Optional, compatible locking hardware
- Not compatible

Selection Guide

| Locking Hardware | | | | | | | |
|------------------------------|--------------------------------|------------------------------------|-----------------------------------|------------------------------------|------------------------------------|----------------------------|---|
| Locking Hook see page 207 | Locking Spring see page 207 | Jackscrew Assembly see page 213 | Jackpost Assembly see page 213 | Recessed Jackscrew see page 201 | Extended Jackscrew see page 201 | Thumbscrew see page 201 | Jackpost for In-Line Connections see page 201 |
| — | — | — | — | • | • | • | • |
| — | — | — | — | • | • | • | • |
| — | — | — | — | — | — | — | — |
| — | — | — | • | — | — | — | — |
| — | — | — | • | — | — | — | — |
| — | — | — | • | — | — | — | — |
| — | — | — | — | — | — | — | — |
| — | — | • | — | — | — | — | — |
| — | — | — | — | — | — | — | — |
| — | — | — | — | — | — | — | — |
| — | — | — | — | — | — | — | — |
| — | — | — | — | — | — | — | — |
| • | • | — | — | — | — | — | — |
| • | • | — | — | — | — | — | — |

Snap-Together Metalized Plastic

Metalized plastic backshells reduce EMI/RFI emissions. Metalized plastic provides a light weight solution. Design includes integral strain relieving cable clamp.

Product Features

- Improves conformance to FCC DOC #20780 shielding requirements
- No crimp ferrule tooling needed
- Quick and simple assembly using snap-together design feature



Attenuation



Note: Cable grounding tang not available on DE size backshell.

Specifications

| | |
|--------------------|-----------------|
| Attenuation: | -49dB @ 100 MHz |
| Temperature Range: | -20° C to 80° C |

Materials and Finishes

| | |
|-----------|-------------------------------|
| Material: | Thermoplastic, UL 94V-0 rated |
| Finish: | Nickel over Copper |

Straight Exit



Kit consists of 1 front shell, 1 rear shell, 1 cable clamp, 2 screws
Optional locking hardware sold separately, see page 201.

| Shell Size | Layout | Part Number | A ±0,15 (.006) | B ±0,30 (.012) | C ±0,30 (.012) | D ±0,30 (.120) | E ±0,20 (.008) | ØH Max. |
|------------|--------|--------------|-------------------|-------------------|-------------------|-------------------|-------------------|--------------|
| DE | 9 | DE121073-154 | 24,95 (.982) | 30,81 (1.213) | 23,70 (.933) | 16,00 (.630) | 35,99 (1.417) | 7,32 (.288) |
| DA | 15 | DA121073-150 | 33,30 (1.311) | 39,09 (1.539) | 31,80 (1.252) | 16,00 (.630) | 42,00 (1.654) | 8,31 (.327) |
| DB | 25 | DB121073-151 | 47,00 (1.850) | 53,01 (2.087) | 45,01 (1.772) | 16,00 (.630) | 42,00 (1.654) | 10,52 (.414) |
| DC | 37 | DC121073-152 | 63,45 (2.498) | 69,29 (2.728) | 60,30 (2.374) | 16,00 (.630) | 42,00 (1.654) | 12,32 (.485) |
| DD | 50 | DD121073-153 | 61,10 (2.410) | 66,90 (2.634) | 58,30 (2.295) | 19,00 (.748) | 42,00 (1.654) | 13,00 (.512) |

40° Exit



Kit consists of 1 front shell, 1 rear shell, 1 cable clamp, 2 screws
Optional locking hardware sold separately, see page 201.

| Shell Size | Layout | Part Number | B ±0,30 (.012) | C ±0,30 (.012) | D ±0,30 (.012) | E ±0,20 (.008) | Cable Diameter | |
|------------|--------|-------------|-------------------|-------------------|-------------------|-------------------|----------------|--------------|
| | | | | | | | Min. | Max. |
| DE | 9 | DE121073-54 | 35,99 (1.417) | 22,00 (.866) | 16,00 (.630) | 35,99 (1.417) | 3,51 (.138) | 7,49 (.295) |
| DA | 15 | DA121073-50 | 44,29 (1.744) | 27,31 (1.075) | 16,00 (.630) | 42,01 (1.654) | 6,50 (.256) | 8,99 (.354) |
| DB | 25 | DB121073-51 | 57,99 (2.283) | 41,00 (1.614) | 16,00 (.630) | 42,01 (1.654) | 6,50 (.256) | 11,00 (.433) |
| DC | 37 | DC121073-52 | 74,50 (2.933) | 57,51 (2.264) | 16,00 (.630) | 42,01 (1.654) | 6,50 (.256) | 11,00 (.433) |
| DD | 50 | DD121073-53 | 72,97 (2.873) | 54,99 (2.165) | 19,00 (.748) | 42,01 (1.654) | 8,99 (.354) | 13,00 (.512) |

Locking Hardware for Snap-Together EMI Shielded Backshell

Recessed Jackscrew



| | |
|----------------------------------|--------------|
| Part Number: | 250-8501-004 |
| Material: | Brass |
| Finish: | Nickel |
| Quantity Required per Connector: | 2 |

Extended Jackscrew



| | |
|----------------------------------|---|
| Part Number: | 250-8501-009 (M3) 250-8501-010 (#4-40) |
| Material: | Brass |
| Finish: | Nickel |
| Quantity Required per Connector: | 2 |

Thumbscrew



| | |
|----------------------------------|--------------|
| Part Number: | 250-8501-013 |
| Material: | Brass |
| Finish: | Nickel |
| Quantity Required per Connector: | 2 |

Jackpost for In-Line Connections

Rectangular Nut



Jackpost



Jackpost Assembly



Assembly consists of 1 rectangular nut, 1 jackpost, 1 #4-40 lock washer.

| | |
|----------------------------------|------------|
| Part Number: | D121073-19 |
| Material: | Brass |
| Finish: | Nickel |
| Quantity Required per Connector: | 2 |

Die Cast Zinc Metal Backshell

Straight Exit



Die cast metal backshells reduce EMI/RFI emissions. Die cast metal backshells offer improved shielding in a rugged package.

Product Features

- Improves conformance to FCC DOC #20780 shielding requirements
- No crimp ferrule tooling needed
- Kit consists of 1 front shell, 1 rear shell, 2 screws, 2 hex nuts, 2 mounting screws, 2 end brackets, 1 set of compression inserts (see this page)

| Shell Size | Layout | Part Number | A ±0,13 (.005) | B ±0,13 (.005) | C ±0,13 (.005) | D ±0,13 (.005) | Ø E ±0,13 (.005) | F ±0,13 (.005) |
|------------|--------|--------------|-------------------|-------------------|-------------------|-------------------|---------------------|-------------------|
| DE | 9 | 980-2000-345 | 31,12 (1.225) | 37,21 (1.465) | 15,75 (.620) | 15,75 (.620) | 10,16 (.400) | 24,99 (.984) |
| DA | 15 | 980-2000-346 | 39,12 (1.540) | 40,64 (1.600) | 15,75 (.620) | 15,75 (.620) | 10,16 (.400) | 33,32 (1.312) |
| DB | 25 | 980-2000-347 | 53,09 (2.090) | 39,37 (1.550) | 17,53 (.690) | 15,75 (.620) | 13,34 (.525) | 47,17 (1.857) |
| DC | 37 | 980-2000-348 | 69,34 (2.730) | 45,72 (1.800) | 21,95 (.864) | 15,75 (.620) | 18,44 (.726) | 63,50 (2.500) |
| DD | 50 | 980-2000-349 | 66,70 (2.626) | 45,72 (1.800) | 21,95 (.864) | 18,54 (.730) | 18,44 (.726) | 61,11 (2.406) |

Specifications

| | |
|--------------------|-------------------|
| Attenuation: | -50 dB @ 1000 MHz |
| Temperature Range: | -20° C to 80° C |

Materials and Finishes

| | |
|----------------------|------------|
| Backshell Material: | Zinc |
| Backshell Finish: | Clear Zinc |
| Compression Inserts: | PVC |
| Hardware Material: | Steel |
| Hardware Finish: | Clear Zinc |

Attenuation



Compression Inserts (Included With Die Cast Zinc Metal Backshell)

Compression inserts accommodate a wide variety of cable sizes.

| Position | Cable Diameter |
|----------|----------------|
| 9, 15 | .190/.350 |
| 25 | .190/.460 |
| 37, 50 | .300/.680 |

9 and 15 Position*



25 Position*



37 and 50 Position*



* Inserts may be supplied mirror image

| Position | #1 O.D. | #1 I.D. | #2 O.D. | #2 I.D. | #3 O.D. | #3 I.D. | #4 O.D. | #4 I.D. | #5 O.D. | #5 I.D. | #6 O.D. | #6 I.D. |
|----------|--------------|--------------|--------------|--------------|--------------|--------------|--------------|--------------|--------------|--------------|--------------|-------------|
| 9, 15 | 12,07 (.475) | 8,13 (.320) | 9,14 (.360) | 8,00 (.315) | 9,14 (.360) | 6,48 (.255) | 9,14 (.360) | 7,24 (.285) | 9,14 (.360) | 5,33 (.210) | — | — |
| 25 | 15,24 (.600) | 11,43 (.450) | 11,43 (.450) | 10,41 (.410) | 11,43 (.450) | 9,40 (.370) | 11,43 (.450) | 7,62 (.300) | 11,43 (.450) | 5,84 (.230) | — | — |
| 37, 50 | 16,64 (.655) | 14,48 (.570) | 17,78 (.700) | 15,75 (.620) | 20,57 (.810) | 16,51 (.650) | 16,64 (.655) | 12,70 (.500) | 16,64 (.655) | 10,80 (.425) | 16,64 (.655) | 8,89 (.350) |

Metal Backshell

Metal Backshells provide strain relief. Various profiles available for different cable routing requirements.

Product Features
Qualified to MIL-Spec M85049

Materials and Finishes

| | |
|---------------------|------------------------------|
| Backshell Material: | Low Carbon Steel |
| Finish: | Yellow Chromate over Cadmium |
| Hardware Material: | Steel |

Deep Straight Clamp



Kit consists of 1 shell, 2 cable clamps, 2 screws, 2 hex nuts

| Shell Size | Layout | Part Number | Mil Spec Part Number | A ±0,38 (.015) | B ±0,572 (.0225) | C ±0,13 (.005) | D max. | E ±0,38 (.015) | F ±0,38 (.015) | G ±0,38 (.015) | H max. |
|------------|--------|-------------|----------------------|----------------|------------------|----------------|--------------|----------------|----------------|----------------|---------------|
| DE | 9 | DE24657 | M85049/48-1-1 | 30,56 (1.203) | 12,484 (.4915) | 24,99 (.984) | 14,68 (.578) | 9,53 (.375) | 9,53 (.375) | 19,05 (.750) | 31,75 (1.250) |
| DA | 15 | DA24658 | M85049/48-1-2 | 38,89 (1.531) | 12,484 (.4915) | 33,32 (1.312) | 14,68 (.578) | 18,11 (.713) | 7,93 (.312) | 19,05 (.750) | 31,75 (1.250) |
| DB | 25 | DB24659 | M85049/48-1-3 | 52,78 (2.078) | 12,484 (.4915) | 47,04 (1.852) | 14,68 (.578) | 25,40 (1.000) | 7,93 (.312) | 25,40 (1.000) | 39,70 (1.563) |
| DC | 37 | DC24660 | M85049/48-1-4 | 69,04 (2.718) | 12,484 (.4915) | 63,50 (2.500) | 14,68 (.578) | 34,93 (1.375) | 7,93 (.312) | 25,40 (1.000) | 39,70 (1.563) |
| DD | 50 | DD24661 | M85049/48-1-5 | 66,68 (2.625) | 15,253 (.6005) | 61,11 (2.406) | 17,45 (.687) | 35,71 (1.406) | 10,31 (.406) | 28,57 (1.125) | 42,88 (1.688) |

Round Cable Clamp



Kit consists of 1 shell, 2 screws, 2 hex nuts

| Shell Size | Layout | Part Number | Mil Spec Part Number | A ±0,38 (.015) | B ±0,38 (.015) | C ±0,13 (.005) | Ø D max. | E ±0,38 (.015) | F ±0,38 (.015) | G ±0,76 (.030) |
|------------|--------|-------------|----------------------|----------------|----------------|----------------|--------------|----------------|----------------|----------------|
| DE | 9 | DE44994 | M85049/48-2-1 | 30,68 (1.208) | 12,70 (.500) | 24,99 (.984) | 10,31 (.406) | 16,79 (.661) | 3,18 (.125) | 26,18 (1.031) |
| DA | 15 | DA20961 | M85049/48-2-2 | 38,89 (1.531) | 12,70 (.500) | 33,33 (1.312) | 10,31 (.406) | 24,99 (.984) | 3,18 (.125) | 26,18 (1.031) |
| DB | 25 | DB20962 | M85049/48-2-3 | 52,78 (2.078) | 12,70 (.500) | 47,04 (1.852) | 15,06 (.593) | 38,48 (1.515) | 4,75 (.187) | 26,98 (1.062) |
| DC | 37 | DC20963 | M85049/48-2-4 | 69,04 (2.718) | 12,70 (.500) | 63,50 (2.500) | 18,23 (.718) | 55,14 (2.171) | 6,35 (.250) | 26,98 (1.062) |
| DD | 50 | DD20964 | M85049/48-2-5 | 66,68 (2.625) | 15,47 (.609) | 61,11 (2.406) | 20,62 (.812) | 53,16 (2.093) | 7,92 (.312) | 26,98 (1.062) |

Short Straight Clamp



Kit consists of 1 shell, 2 or 3 screws,
2 or 3 hex nuts



| Shell Size | Layout | Part Number | Mil Spec Part Number | No. of Cable Locking Screws Included | A | B | C | E | F | G |
|------------|--------|-------------|----------------------|--------------------------------------|---------------|--------------|---------------|--------------|--------------|--------------|
| | | | | | ±0,38 (.015) | ±0,38 (.015) | ±0,13 (.005) | ±0,38 (.015) | ±0,38 (.015) | ±0,89 (.035) |
| DA | 15 | DA19678-1 | M85049/48-3-2 | 2 | 38,88 (1.531) | 12,70 (.500) | 33,33 (1.312) | 7,51 (.296) | 7,93 (.312) | 16,36 (.644) |
| DB | 25 | DB19678-2 | M85049/48-3-3 | 2 | 52,78 (2.078) | 12,70 (.500) | 47,04 (1.852) | 7,51 (.296) | 20,22 (.796) | 16,36 (.644) |
| DC | 37 | DC19678-3 | M85049/48-3-4 | 3 | 69,04 (2.718) | 12,70 (.500) | 63,50 (2.500) | 7,51 (.296) | 17,45 (.687) | 16,36 (.644) |
| DD | 50 | DD19678-4 | M85049/48-3-5 | 3 | 66,68 (2.625) | 15,47 (.609) | 61,11 (2.406) | 9,91 (.390) | 17,45 (.687) | 17,63 (.694) |

DE-9 is not available.

90° Entry



Kit consists of 1 shell, 1 cable clamp, 1 screw,
1 nut, 2 rivnuts (assembled)



| Shell Size | Layout | Part Number | Mil Spec Part Number | A | B | C | E | F | G | H |
|------------|--------|-------------|----------------------|---------------|---------------|---------------|--------------|--------------|--------------|--------------|
| | | | | ±0,38 (.015) | ±0,76 (.030) | ±0,13 (.005) | ±0,76 (.030) | ±0,76 (.030) | ±0,76 (.030) | ±0,76 (.030) |
| DE | 9 | DE19977-5 | M85049/50-1 | 30,56 (1.203) | 18,24 (.718) | 24,99 (.984) | 11,10 (.437) | 11,10 (.437) | 11,89 (.468) | 7,14 (.281) |
| DA | 15 | DA19977-1 | M85049/50-2 | 38,89 (1.531) | 18,24 (.718) | 33,33 (1.312) | 11,10 (.437) | 11,10 (.437) | 11,89 (.468) | 7,14 (.281) |
| DB | 25 | DB19977-2 | M85049/50-3 | 52,78 (2.078) | 24,58 (.968) | 47,04 (1.852) | 11,10 (.437) | 15,88 (.625) | 11,89 (.468) | 7,14 (.281) |
| DC | 37 | DC19977-3 | M85049/50-4 | 69,04 (2.718) | 30,15 (1.187) | 63,50 (2.500) | 11,10 (.437) | 20,63 (.812) | 11,89 (.468) | 7,14 (.281) |
| DD | 50 | DD19977-4 | M85049/50-5 | 66,68 (2.625) | 31,75 (1.250) | 61,11 (2.406) | 14,28 (.562) | 23,01 (.906) | 13,49 (.531) | 8,71 (.343) |

Plastic Backshell

Snap-Together Universal



A 2-piece snap-together design for quick assembly
Customer furnishes tie-wrap

Materials and Finishes

Material: Black Thermoplastic, UL 94V-0 rated

| Shell Size | Layout | Part Number | Ø B max. | C ±0,20 (.008) | D ±0,20 (.008) |
|------------|--------|-------------|--------------|----------------|----------------|
| DE | 9 | DE115339-20 | 7,01 (.276) | 17,00 (.669) | 19,51 (.768) |
| DA | 15 | DA115339-21 | 9,60 (.378) | 17,00 (.669) | 27,79 (1.094) |
| DB | 25 | DB115339-22 | 11,61 (.457) | 17,00 (.669) | 41,61 (1.638) |
| DC | 37 | DC115339-23 | 13,00 (.512) | 17,00 (.669) | 57,99 (2.283) |
| DD | 50 | DD115339-24 | 16,00 (.630) | 19,81 (.780) | 52,32 (2.060) |

One-Piece Snap-Together



Low cost
Easy to assemble
Mounting hardware included
2 thumbscrews, 2 cable clamps

Materials and Finishes

Backshell Material: Polypropylene
Hardware Material: Steel
Hardware Finish: Yellow chromate over zinc

| Shell Size | Layout | Part Number | A | C | Ø D max. | E |
|------------|--------|-------------|---------------|---------------|-------------|---------------|
| DE | 9 | DEBS-9 | 35,20 (1.386) | 24,99 (.984) | 5,69 (.224) | 27,51 (1.083) |
| DA | 15 | DABS-15 | 43,31 (1.705) | 33,33 (1.312) | 5,69 (.224) | 31,19 (1.228) |
| DB | 25 | DBBS-25 | 57,20 (2.252) | 47,04 (1.852) | 6,50 (.256) | 38,30 (1.508) |

DC-37 and DD-50 are not available.

One-Piece Plastic

Straight Exit



Kit consists of 1 shell, 1 cable clamp,
1 set screw
Mounting hardware included
2 screws #4-24 x 5/16 long self-tapping
Accommodates spring latches



Materials and Finishes

| | |
|---------------------|--------------------------------------|
| Backshell Material: | Black Thermoplastic, UL 94V-2 rated |
| Hardware Material: | Steel |
| Hardware Finish: | Yellow Chromate over Cadmium or Zinc |

| Shell Size | Layout | Part Number | A ±0,38 (.015) | B ±0,38 (.015) | C ±0,13 (.005) | D ±0,38 (.015) | Ø E ±0,25 (.010) | F ±0,25 (.010) | G ±0,25 (.010) |
|------------|--------|-------------|----------------|----------------|----------------|----------------|------------------|----------------|----------------|
| DE | 9 | DE51218 | 30,94 (1.218) | 25,40 (1.000) | 24,99 (.984) | 12,70 (.500) | 7,14 (.281) | — | — |
| DA | 15 | DA51210 | 39,27 (1.546) | 25,40 (1.000) | 33,33 (1.312) | 12,70 (.500) | 9,14 (.360) | — | — |
| DB | 25 | DB51212 | 53,16 (2.093) | 31,75 (1.250) | 47,04 (1.852) | 12,70 (.500) | — | 12,52 (.493) | 9,15 (.360) |
| DC | 37 | DC51214 | 69,44 (2.734) | 38,10 (1.500) | 63,50 (2.500) | 12,70 (.500) | — | 17,63 (.694) | 9,15 (.360) |
| DD | 50 | DD51216 | 67,06 (2.640) | 38,10 (1.500) | 61,11 (2.406) | 15,47 (.609) | — | 18,64 (.734) | 11,89 (.468) |

90° Exit



Kit consists of 1 shell, 1 cable clamp,
1 set screw
Mounting hardware included
2 screws #4-24 x 5/16 long self-tapping



Materials and Finishes

| | |
|---------------------|--------------------------------------|
| Backshell Material: | Black Thermoplastic, UL 94V-2 rated |
| Hardware Material: | Steel |
| Hardware Finish: | Yellow Chromate over Cadmium or Zinc |

| Shell Size | Layout | Part Number | A ±0,38 (.015) | B ±0,38 (.015) | C ±0,13 (.005) | D ±0,38 (.015) | Ø H ±0,25 (.010) | J ±0,25 (.010) | K ±0,25 (.010) |
|------------|--------|-------------|----------------|----------------|----------------|----------------|------------------|----------------|----------------|
| DE | 9 | DE51219 | 37,95 (1.494) | 25,40 (1.000) | 24,99 (.984) | 12,70 (.500) | 7,14 (.281) | — | — |
| DA | 15 | DA51211 | 46,28 (1.822) | 25,40 (1.000) | 33,33 (1.312) | 12,70 (.500) | 9,14 (.360) | — | — |
| DB | 25 | DB51213 | 60,15 (2.368) | 31,75 (1.250) | 47,04 (1.852) | 12,70 (.500) | — | 12,52 (.493) | 9,15 (.360) |
| DC | 37 | DC51215 | 76,43 (3.009) | 38,10 (1.500) | 63,50 (2.500) | 12,70 (.500) | — | 17,63 (.694) | 9,15 (.360) |
| DD | 50 | DD51217 | 74,04 (2.915) | 38,10 (1.500) | 61,11 (2.406) | 15,47 (.609) | — | 18,64 (.734) | 11,89 (.468) |

Dataphone



Available in 25 position only
Mounting hardware included
2 screws #4-40 x 11/16 long



Materials and Finishes

| | |
|---------------------|-------------------------------------|
| Backshell Material: | Black Thermoplastic, UL 94V-0 rated |
| Hardware Material: | Steel |
| Hardware Finish: | Clear Chromate over Cadmium or Zinc |

| Shell Size | Layout | Part Number | Max. Cable Entry |
|------------|--------|-------------|------------------|
| DB | 25 | DB51226-1B | 7,92 (.312) |

Quick Disconnect for IDC Cable

IDC



Kit consists of 1 front shell, 1 rear shell, 2 strain reliefs, 5 screws



* Order optional locking hardware separately.

Materials and Finishes

Material: Black Thermoplastic, UL 94V-0 rated

| Shell Size | Layout | Part Number | A max. | C ±0,13 (.005) | E ±0,20 (.008) |
|------------|--------|-------------|---------------|----------------|----------------|
| DE | 9 | DE115386-1B | 40,69 (1.602) | 24,99 (.984) | 14,99 (.590) |
| DA | 15 | DA115386-2B | 49,00 (1.929) | 33,30 (1.311) | 23,29 (.917) |
| DB | 25 | DB115386-3B | 62,69 (2.468) | 47,04 (1.852) | 36,98 (1.456) |
| DC | 37 | DC115386-4B | 79,20 (3.118) | 63,50 (2.500) | 53,49 (2.106) |

Quick Disconnect for Round Cable

Straight and 90° Exit



Kit consists of 1 front shell, 1 rear shell, 1 cable clamp, 1 spacer, 4 self-tapping screws, 2 machined screws



* Order optional locking hardware separately.

Materials and Finishes

Material: Black Thermoplastic, UL 94V-0 rated

| Shell Size | Layout | Part Number | A max. | B max. | C ±0,15 (.006) | D max. | E min. | F min. |
|------------|--------|-------------|---------------|---------------|----------------|--------------|--------------|--------------|
| DE | 9 | DE115339 | 41,33 (1.627) | 32,41 (1.276) | 25,00 (.984) | 16,51 (.650) | 7,70 (.303) | 6,70 (.264) |
| DA | 15 | DA115339-1 | 49,63 (1.954) | 32,41 (1.276) | 33,30 (1.311) | 16,51 (.650) | 7,70 (.303) | 6,70 (.264) |
| DB | 25 | DB115339-2 | 63,65 (2.506) | 40,44 (1.592) | 47,04 (1.852) | 16,51 (.650) | 7,70 (.303) | 17,70 (.697) |
| DC | 37 | DC115339-3 | 79,86 (3.144) | 42,42 (1.670) | 63,50 (2.500) | 16,51 (.650) | 7,70 (.303) | 17,70 (.697) |
| DD | 50 | DD115339-4 | 77,57 (3.054) | 42,42 (1.670) | 61,10 (2.406) | 19,51 (.768) | 10,69 (.421) | 17,70 (.697) |

Optional Locking Hardware/Mechanism

Optional hardware provides quick disconnect for either flat IDC cable or round jacketed cable.

Order 2 per connector

Material: Corrosion-resistant steel

Locking Hook



Locking Spring



| Lock Hook Part Number |
|-----------------------|
| 015-8755-000 |
| 015-8755-001 |

| Lock Spring Part Number |
|-------------------------|
| 259-8760-000 |

NOTE: Not for use on rear panel mounted connectors.

Screw Lock Assemblies

ITT Cannon offers the largest variety of locking and latching hardware. Refer to the accessories selection guide on pages 198-199 for use with ITT Cannon backshells.

Product Features

- Ensures positive mating
- Provides locking and latching for high vibration applications



Male Screw Lock



Kit consists of 1 screw and 1 clip
Order 2 per connector

| | |
|-----------|--------------------------------------|
| Material: | Steel |
| Finish: | Yellow Chromate over Cadmium or Zinc |

| Shell Size | Part Number | A ±0,38 (.015) | B ±0,25 (.010) | C ±0,13 (.005) |
|----------------|-------------|-------------------|-------------------|-------------------|
| DE, DA, DB, DC | D20419 | 14,10 (.555) | 6,35 (.250) | 1,22 (.048) |
| DE, DA, DB, DC | D20419-18 | 14,10 (.555) | 7,14 (.281) | 1,70 (.067) |
| DE, DA, DB, DC | D20419-21 | 14,10 (.555) | 7,14 (.281) | 2,34 (.092) |
| DE, DA, DB, DC | D20419-104 | 14,10 (.555) | 7,92 (.312) | 2,34 (.092) |
| DD | D20420 | 16,66 (.656) | 6,35 (.250) | 1,22 (.048) |
| DD | D20420-13 | 16,66 (.656) | 7,14 (.281) | 1,70 (.067) |
| DD | D20420-15 | 16,66 (.656) | 7,14 (.281) | 2,34 (.092) |
| DD | D20420-86 | 16,66 (.656) | 7,92 (.312) | 2,34 (.092) |

Female Screw Lock



Kit consists of 1 nut, 3 washers, 1 lock washer, 1 hex nut
Order 2 per connector

Material: Steel

Front Panel Mount



Rear Panel Mount



NOTE: (1) A 6 inch/pound (female) and 4 inch/pound (male) maximum torque during assembly is recommended on steel screw lock assemblies.
(2) A third flat washer is supplied for front panel mounting of tab shell connectors.

| Yellow Chromate over Cadmium | Mil Spec Part Number | Zinc With Clear Chromate | A |
|------------------------------|----------------------|--------------------------|--------------|
| D20418-2 | M24308/26-1 | D20418-80 | 7,92 (.312) |
| D20418-50 | — | — | 12,70 (.500) |
| D20418-39 | M24308/26-2 | — | 15,88 (.625) |
| D20418-74 | — | — | 19,05 (.750) |

Female Screw Lock for High Volume Applications



Order 2 per connector
Tool required for installation. See page 211.

Material: Steel

Finish: Zinc



NOTE: Not suitable for rear panel mounting.

| Part Number | Thread Code | Nominal Panel Thickness |
|--------------|-------------|---------------------------|
| 980-2000-858 | #4-40 | 1,09 - 0,91 (.043 - .036) |
| 980-2000-859 | M3 | 1,09 - 0,91 (.043 - .036) |

Screw Locks for Connectors with Integral Threaded Inserts



Kit consists of 1 jackpost, 1 lock washer
Order 2 per connector

Material: Brass

Finish: Nickel

Jackpost



| Part Number | Thread Code | |
|-------------|--------------|--------------|
| | THD A | THD B |
| D121073-39 | #4-40 UNC-2B | #4-40 UNC-2A |
| D121073-40 | M3 | #4-40 UNC-2A |
| D121073-41 | #4-40 UNC-2B | M3 |
| D121073-42 | M3 | M3 |

Slide Lock Assemblies

ITT Cannon offers the largest variety of locking and latching hardware. Refer to the accessories selection guide on pages 198-199 for use with ITT Cannon backshells.

Product Features

- Ensures positive mating
- Provides locking and latching for high vibration applications



Sliding Lock Retainer Assembly



Ideal for Ethernet Applications
 Kit consists of 1 sliding lock plate, 2 mounting screws, 2 lock washers, 2 hex nuts
 Order 1 kit per connector



| Description | Material | Finish/Treatment |
|--------------------|-----------------|--------------------------------------|
| Sliding Lock Plate | Stainless Steel | Passivated |
| Screw, Mounting | Steel | Yellow Chromate Over Cadmium or Zinc |
| Washer, Lock | | |
| Nut, Hex | | |

| Shell Size | Layout | Part Number | A ±0,38 (.015) | B ±0,38 (.015) | C ±0,13 (.005) |
|------------|--------|-------------|-------------------|-------------------|-------------------|
| DE | 9 | DE51224-1 | 35,05 (1.380) | 12,70 (.500) | 25,00 (.984) |
| DA | 15 | DA51220-1* | 43,70 (1.720) | 12,70 (.500) | 33,32 (1.312) |
| DB | 25 | DB51221-1 | 57,40 (2.260) | 12,70 (.500) | 47,04 (1.852) |
| DC | 37 | DC51222-1 | 73,86 (2.908) | 12,70 (.500) | 63,50 (2.500) |
| DD | 50 | DD51223-1 | 71,47 (2.814) | 15,47 (.609) | 61,11 (2.406) |

* Meets IEEE 802.3 Ethernet Specification

Slide Lock Post Assemblies



Kit consists of 1 post, 2 washers, 1 lock washer, 1 hex nut
 Order 2 kits per connector

Part Number: D53018

Materials and Finishes

Material: Steel

Finish: Yellow Chromate over Cadmium or Zinc



NOTE: When rear-mounting connector to a 1/16" panel, delete the 2 washers.

Slide Lock Post for High Volume Applications



Order 2 per connector
 Tool required for installation. See this page.

Part Number: 980-2000-860

Panel Thickness: 1,09-0,91 (.043-.036)

Materials and Finishes

Material: Stainless Steel

Treatment: Passivated



NOTE: Not suitable for rear panel mounting

Tool for High Volume Applications



Part Number: 995-2000-092

Spring Latch Assemblies

ITT Cannon offers the largest variety of locking and latching hardware. Refer to the accessories selection guide on pages 198-199 for use with ITT Cannon Connectors.

Product Features

- Low Cost
- Minimizes field connection time
- Positive lock between connectors
- Packaged 2 kits per bag

Materials and Finishes

| | |
|------------|-----------------|
| Material: | Stainless Steel |
| Treatment: | Passivated |

Unlocked



Locked



Spring Latch Plate Assembly



| Shell Size | Layout | Part Number | A ±0,38 (.015) | B ±0,38 (.015) |
|----------------|---------------|-------------|-------------------|-------------------|
| DE, DA, DB, DC | 9, 15, 25, 37 | D110278 | 12,42 (.489) | 14,35 (.565) |
| DD | 50 | D110280 | 15,47 (.609) | 17,09 (.673) |

Kit consists of 1 plate, 1 screw, 1 lock washer, 1 hex nut
Order 2 kits per connector

Spring Latch Assembly



* Dimension does not apply to rear panel mounting.

| Shell Size | Layout | Part Number | A ±0,38 (.015) | B ±0,38 (.015) | C ±0,51 (.020) |
|----------------|---------------|-------------|-------------------|-------------------|-------------------|
| DE, DA, DB, DC | 9, 15, 25, 37 | D110277 | 12,42 (.489) | 14,35 (.565) | 18,59 (.732) |
| DD | 50 | D110279 | 15,49 (.609) | 17,09 (.673) | 18,59 (.732) |

Kit consists of 1 spring, 1 screw, 1 bracket, 1 lock washer, 1 hex nut
Order 2 kits per connector
Front panel mounting

Jackscrew/Jackpost Assemblies

ITT Cannon offers the largest variety of locking and latching hardware. Refer to the accessories selection guide on pages 198-199 for use with ITT Cannon Connectors.



Jackscrew Assembly



Kit consists of 2 studs, 2 heads, 1 tube retaining compound
Order one kit per connector

| | |
|------------------------|-----------------|
| Part Number: | D110550 |
| Materials and Finishes | |
| Material: | Stainless Steel |



Jackpost Assembly



Kit consists of 2 posts, 2 hex nuts, 2 lock washers
Order one kit per connector

| | |
|------------------------|-----------------|
| Part Number: | D110551 |
| Materials and Finishes | |
| Material: | Stainless Steel |
| Treatment: | Passivated |



NOTE: Jackpost is not compatible with rear-panel mount connectors.

Guide Pin Plate

Female



Useful in blind mate applications.
 Kit consists of 1 plate, 2 screws
 Guide pin inserts for Size 8 cavities for
 Combo D® connectors also available. See
 page 95.



Plate and Hardware Material: Steel
 Plate and Hardware Finish: Yellow Chromate over Zinc or Cadmium

| Shell Size | Layout | Part Number | ±0,41 (.016) | ±0,13 (.005) | ±0,13 (.005) | ±0,13 (.005) | ±0,13 (.005) | ±0,13 (.005) | ±0,13 (.005) | ±0,41 (.016) | ±0,41 (.016) | ±0,41 (.016) |
|------------|--------|-------------|---------------|---------------|---------------|---------------|---------------|--------------|---------------|---------------|--------------|--------------|
| DE | 9 | DE111920 | 49,61 (1.953) | 40,08 (1.578) | 25,00 (.986) | 18,65 (.734) | 15,27 (.601) | 9,52 (.375) | 25,40 (1.000) | 30,58 (1.204) | 12,29 (.484) | 6,15 (.242) |
| DA | 15 | DA22214 | 57,96 (2.282) | 48,41 (1.906) | 33,32 (1.312) | 22,81 (.898) | 19,43 (.765) | 9,52 (.375) | 25,40 (1.000) | 38,91 (1.532) | 12,29 (.484) | 6,15 (.242) |
| DB | 25 | DB22254 | 71,63 (2.820) | 62,13 (2.446) | 47,04 (1.852) | 29,67 (1.168) | 26,29 (1.035) | 9,52 (.375) | 25,40 (1.000) | 51,21 (2.016) | 11,91 (.469) | 5,94 (.234) |
| DC | 37 | DC22071 | 88,11 (3.469) | 78,59 (3.094) | 63,50 (2.500) | 37,90 (1.492) | 34,52 (1.359) | 9,52 (.375) | 25,40 (1.000) | 67,49 (2.657) | 11,91 (.469) | 5,94 (.234) |
| DD | 50 | DD21961 | 85,72 (3.375) | 76,20 (3.000) | 61,11 (2.406) | 36,50 (1.437) | 33,32 (1.312) | 11,10 (.437) | 28,58 (1.125) | 65,10 (2.563) | 14,30 (.563) | 7,16 (.282) |



Guide Pin Plate

Male



Useful in blind mate applications.
 Kit consists of 1 plate, 2 sems screws,
 2 rivets, 2 guide pins, 2 washers
 Guide pin inserts for Size 8 cavities for
 Combo D® connectors also available. See
 page 95.



| | |
|------------------------------|--------------------------------------|
| Plate and Hardware Material: | Steel |
| Plate and Hardware Finish: | Yellow Chromate over Zinc or Cadmium |
| Guide Pin Material: | Stainless Steel |

| Shell Size | Layout | Part Number | A $\pm 0,38 (.015)$ | B $\pm 0,13 (.005)$ | C $\pm 0,25 (.010)$ | D $\pm 0,13 (.005)$ | E $\pm 0,38 (.015)$ | F $\pm 0,25 (.010)$ | G $\pm 0,13 (.005)$ | H $\pm 0,25 (.010)$ | J $\pm 0,38 (.015)$ | K $\pm 0,13 (.005)$ |
|------------|--------|-------------|------------------------|------------------------|------------------------|------------------------|------------------------|------------------------|------------------------|------------------------|------------------------|------------------------|
| DE | 9 | DE111919 | 49,61 (1.953) | 40,08 (1.578) | 33,91 (1.335) | 18,65 (.734) | 25,40 (1.000) | 19,05 (.750) | 25,00 (.984) | 12,29 (.484) | 30,58 (1.204) | 6,15 (.242) |
| DA | 16 | DA22213 | 57,94 (2.281) | 48,41 (1.906) | 42,24 (1.663) | 22,81 (.898) | 25,40 (1.000) | 19,05 (.750) | 33,32 (1.312) | 12,29 (.484) | 38,89 (1.531) | 6,15 (.242) |
| DB | 25 | DB22255 | 71,63 (2.820) | 62,13 (2.446) | 55,96 (2.203) | 29,67 (1.168) | 25,40 (1.000) | 19,05 (.750) | 47,04 (1.852) | 12,29 (.484) | 51,99 (2.047) | 6,15 (.242) |
| DC | 37 | DC22070 | 88,09 (3.468) | 78,42 (3.094) | 72,42 (2.851) | 37,90 (1.492) | 25,40 (1.000) | 19,05 (.750) | 63,50 (2.500) | 12,29 (.484) | 68,25 (2.687) | 6,15 (.242) |
| DD | 50 | DD21962 | 85,72 (3.375) | 76,20 (3.000) | 69,82 (2.749) | 36,50 (1.437) | 28,58 (1.125) | 22,20 (.874) | 61,11 (2.406) | 15,06 (.593) | 66,93 (2.635) | 7,52 (.296) |



Connector Saver

Connector Saver



Connector Savers are used to minimize wear on cable or panel connectors.



Note: Hardware removed for clarity.

| Shell Size | Layout | Part Numbers | A ±0,40 (.015) | B ±0,25 (.010) | C ±0,25 (.010) |
|------------|--------|--------------|-------------------|-------------------|-------------------|
| DE | 9 | DEBU111515 | 30,81 (1.213) | 24,99 (.984) | 16,92 (.666) |
| DA | 15 | DABU111512 | 39,14 (1.541) | 33,32 (1.312) | 25,25 (.994) |
| DB | 25 | DBBU111511 | 53,04 (2.088) | 47,04 (1.852) | 38,96 (1.534) |

Note: DC-37 and DD-50 not available.

Specifications

Temperature: -55° C to 105° C

Current Rating: 7 A

Dielectric Withstanding Voltage: 500 VAC at Sea Level

Materials and Finishes

| Description | Material | Finish |
|------------------|-------------------------------|--------------------------|
| Shells | Steel | Tin/Lead |
| Insulator | Black Thermoplastic, UL 94V-0 | — |
| Contacts | Copper Alloy | Gold Over Nickel |
| Spacer | Zinc Alloy | — |
| Locking Hardware | Steel | Clear Chromate Over Zinc |

Gender Changer

Male/Male



Gender Changers modify the mating interface to allow connectors of the same genders to mate.



Product Features

- Low cost way to correct design errors
- Optional hardware allows design flexibility

Note: Grounding dimples available on male/male only.

| Shell Size | Layout | Part Number Without Hardware | Part Number With Hardware | A ±0,38 (.015) | B ±0,13 (.005) | C ±0,13 (.005) |
|------------|--------|------------------------------|---------------------------|-------------------|-------------------|-------------------|
| DE | 9 | DE111805-1 | DE111805-5 | 30,81 (1.213) | 24,99 (.984) | 16,92 (.666) |
| DA | 15 | DA111806-1 | DA111806-5 | 39,14 (1.541) | 33,32 (1.312) | 25,25 (.994) |
| DB | 25 | DB111807-1 | DB111807-5 | 53,04 (2.088) | 47,04 (1.852) | 38,96 (1.534) |
| DC | 37 | DC111808-1 | DC111808-5 | 69,32 (2.729) | 63,50 (2.500) | 55,42 (2.182) |

Note: DD-50 not available in male/male.

Female/Female



Gender Changers modify the mating interface to allow connectors of the same genders to mate.



Product Features

- Low cost way to correct design errors
- Optional hardware allows design flexibility

| Shell Size | Layout | Part Number Without Hardware | Part Number With Hardware | A ±0,38 (.015) | B ±0,13 (.005) | C ±0,13 (.005) |
|------------|--------|------------------------------|---------------------------|-------------------|-------------------|-------------------|
| DE | 9 | DE111813 | DE111813-3 | 30,81 (1.213) | 24,99 (.984) | 16,33 (.643) |
| DA | 15 | DA111810 | DA111810-3 | 39,14 (1.541) | 33,32 (1.312) | 24,66 (.971) |
| DB | 25 | DB111811 | DB111811-2 | 53,04 (2.088) | 47,04 (1.852) | 38,38 (1.511) |

Note: DC-37 and DD-50 not available for female/female.

Specifications

Temperature: -55° C to 105° C

Current Rating: 3 A

Dielectric Withstanding Voltage: 500 VAC at Sea Level

Materials and Finishes

| Description | Material | Finish |
|------------------|--------------|---|
| Shells | Steel | Tin/Lead |
| Insulator | M/M | Glass Epoxy |
| | F/F | Black Thermoplastic, UL 94V-0 |
| Contacts | Copper Alloy | Gold Over Nickel |
| Rivets (M/M) | Copper Alloy | Tin/Lead |
| Locking Hardware | Steel | Clear Chromate Over Cadmium or Zinc and Mylar |

Dust Cap



Dust caps provide protection from moisture and dust for unused I/O ports.



Product Features

Conductive Dust Caps provide a surface resistivity of at least 1×10^9 ohms/sq. Dust Caps meet the static decay test requirements of MIL-B-81705C, Type II. Dust Caps have an integral flange for easy application and removal.

NOTE: C dim. applies at point of maximum integral interface length.

| Part Number | I.D. | A | B | C | D |
|-------------|--------|---------------|--------------|---------------|--------------|
| DE-59-20 | Socket | 20,32 (.800) | 11,43 (.450) | 16,36 (.644) | 7,59 (.299) |
| DA-59-20 | Socket | 28,45 (1.120) | 11,68 (.460) | 24,59 (.968) | 7,62 (.300) |
| DB-59-20 | Socket | 42,42 (1.670) | 11,68 (.460) | 38,25 (1.506) | 7,49 (.295) |
| DC-59-20 | Socket | 58,93 (2.320) | 11,68 (.460) | 54,81 (2.158) | 7,37 (.290) |
| DD-59-20 | Socket | 56,90 (2.240) | 14,48 (.570) | 53,11 (2.091) | 10,41 (.410) |
| DE-60-20 | Pin | 21,84 (.860) | 12,95 (.510) | 17,78 (.700) | 8,92 (.351) |
| DA-60-20 | Pin | 30,48 (1.200) | 12,95 (.510) | 26,52 (1.044) | 9,02 (.355) |
| DB-60-20 | Pin | 44,20 (1.740) | 13,46 (.530) | 39,60 (1.559) | 9,09 (.358) |
| DC-60-20 | Pin | 60,71 (2.390) | 13,46 (.530) | 56,90 (2.240) | 9,37 (.369) |
| DD-60-20 | Pin | 58,17 (2.290) | 16,00 (.630) | 54,28 (2.137) | 12,04 (.474) |

Materials and Finishes

Material: Black Polyethylene

Interfacial Seal



Interfacial seals provide moisture resistance at the mating interface.



Product Features

Other Interfacial Seals in the Combo D® layouts are available upon request.

Materials and Finishes

Material: Silastic Sheet

| Shell Size | Layout | Part Number | A | B |
|------------|--------|--------------|---------------|--------------|
| DE | 9 | DE53750 | 16,66 (.656) | 8,41 (.331) |
| DA | 15 | DA53750-1 | 24,99 (.984) | 8,41 (.331) |
| DB | 25 | DB53750-2 | 38,88 (1.531) | 8,41 (.331) |
| DC | 37 | DC53750-3 | 55,14 (2.171) | 8,41 (.331) |
| DD | 50 | DD53750-4 | 52,78 (2.078) | 11,10 (.437) |
| DC | 21WA4 | 075-0354-003 | 55,14 (2.171) | 8,41 (.331) |

Potting Shell



Potting shells are molded with a thin flange 0,76 (.030) to permit the use of D Subminiature locking devices. Potting shells hold epoxy in place during curing.

Materials and Finishes

Material: Nylon

Color: Natural (white)

| Shell Size | Layout | Part Number |
|------------|--------|-------------|
| DE | 9 | DE50904-1 |
| DA | 15 | DA50905-1 |
| DB | 25 | DB50906-1 |
| DC | 37 | DC50907-1 |
| DD | 50 | DD50908-1 |

D Subminiature

| | Page |
|--|------|
| Selection Index | |
| Reader's Resource | |
| Dimensional Reference Data | |
| Panel Mounting | 220 |
| Panel Cutouts | 221 |
| Contact Cavity Arrangements | |
| Combo D® — Plug | 222 |
| Combo D® — Receptacle | 223 |
| Standard — Plug and Receptacle | 224 |
| Pushfit/Boardlock — Standard and European | 225 |
| Alternate Technical Configurations | |
| 50 Ohm Coaxial Contact — Straight and 90° | 225 |
| Bracket — Standard and European | 226 |
| Hardware Views | |
| Standard | 226 |
| European | 227 |
| Printed Circuit Board (PCB) Hole Patterns | |
| Combination Layouts | |
| Coaxial 90° — Standard | |
| Plug | 228 |
| Receptacle | 231 |
| Coaxial 90° — European | |
| Plug | 234 |
| Receptacle | 236 |
| Coaxial Straight — Standard/European | |
| Plug | 238 |
| Receptacle | 241 |
| High Power 90° — Standard | |
| Plug | 244 |
| Receptacle | 247 |
| High Power 90° — European | |
| Plug | 250 |
| Receptacle | 252 |
| High Power/High Voltage Straight — Standard/European | |
| Plug | 254 |
| Receptacle | 257 |
| 90° PC Tails (Size 20 Signal Contacts only) — European | |
| Plug | 260 |
| Receptacle | 263 |
| Straight PC Tails (Size 20 Signal Contacts only) — Standard/European | |
| Plug | 266 |
| Receptacle | 269 |
| Standard Layouts | |
| 90° Standard — Plug and Receptacle | 272 |
| 90° European — Plug and Receptacle | 273 |
| Straight PC Tails — Plug and Receptacle Standard/European | 274 |
| Lease Tooling | 275 |
| Glossary of Terms | 276 |
| Obsolete Products/Available Products Not Previously Listed | 282 |
| Part Number Index | 283 |
| Product Safety and Warranty | 297 |

Panel Mounting

Figure 1A



Figure 1B



Figure 2



Figure 3



| Figure Number | Combination of Mated Connectors | | A +0,76 (.030) | B +0,76 (.030) | C +0,76 (.030) | F ±0,25 (.010) | H +0,76 (.030) | |
|---------------|---------------------------------|----------------------|---------------------|-------------------|-------------------|-------------------|-------------------|-------------|
| | Size | Pin (See Note Below) | | | | | | Socket |
| 1A, 1B | A, E | Standard | Standard | 6,35 (.250) | 8,63 (.340) | 7,49 (.295) | — | 7,49 (.295) |
| 1A, 1B | B, C, D | Standard | Standard | 6,04 (.238) | 8,71 (.343) | 7,56 (.298) | — | 7,18 (.283) |
| 2 | A, E | Standard | Float Mount | 5,53 (.218) | — | 6,68 (.263) | 3,04 (.120) | — |
| 2 | B, C, D | Standard | Float Mount | 5,23 (.206) | — | 6,75 (.266) | 3,04 (.120) | — |
| 2 | A, E | Float Mount | Standard | 5,53 (.218) | — | 6,68 (.263) | 3,04 (.120) | — |
| 2 | B, C, D | Float Mount | Standard | 5,23 (.206) | — | 6,37 (.251) | 3,30 (.130) | — |
| 3 | A, E | Standard | Reverse Float Mount | — | 9,09 (.358) | 7,95 (.313) | 3,04 (.120) | — |
| 3 | B, C, D | Standard | Reverse Float Mount | — | 9,16 (.361) | 7,64 (.301) | 3,04 (.120) | — |
| 3 | A, E | Reverse Float Mount | Standard | — | 9,09 (.358) | 7,95 (.313) | 3,04 (.120) | — |
| 3 | B, C, D | Reverse Float Mount | Standard | — | 9,01 (.355) | 7,87 (.310) | 3,30 (.130) | — |

- Notes:
1. A, B, C and H are dimensions between panels and represent the recommended limit to be used in the design of the connector mounting method.
 2. It is recommended that only one assembly, either pin or socket, be float mounted.
 3. Standard pin assemblies contained 0,38 (.015) thick front shells on E and A sizes; 0,61 (.024) thick front shells on B, C, and D sizes.
 4. Standard connectors accommodate a #4 screw. Float mount connectors accommodate a #2 screw.

Panel Cutouts

Standard Cutout



Rear Mounting Cutout (Optional)



Front Panel Mounting



Standard Shell



Dual Float Mount Shell

Rear Panel Mounting



Standard Shell



Dual Float Mount Shell

Standard Shell

| Shell Size | Mounting Method | A ±0,13 (.005) | B ±0,13 (.005) | C ±0,13 (.005) | D ±0,13 (.005) | E ±0,13 (.005) | F ±0,13 (.005) | G ±0,05 (.002) | H ±0,05 (.002) | J ±0,05 (.002) |
|------------|-----------------|-------------------|-------------------|-------------------|-------------------|-------------------|-------------------|-------------------|-------------------|-------------------|
| DE | Front | 22,19 (.874) | 11,09 (.437) | 24,99 (.984) | 12,49 (.492) | 13,03 (.513) | 6,52 (.257) | 3,04 (.120) | 1,52 (.060) | 2,10 (.083) |
| | Rear | 20,47 (.806) | 10,23 (.403) | 24,99 (.984) | 12,49 (.492) | 11,40 (.449) | 5,71 (.225) | 3,04 (.120) | 1,52 (.060) | 3,35 (.132) |
| DA | Front | 30,53 (1.202) | 15,26 (.601) | 33,32 (1.312) | 16,66 (.656) | 13,03 (.513) | 6,52 (.257) | 3,04 (.120) | 1,52 (.060) | 2,10 (.083) |
| | Rear | 28,80 (1.134) | 14,40 (.567) | 33,32 (1.312) | 16,66 (.656) | 11,40 (.449) | 5,71 (.225) | 3,04 (.120) | 1,52 (.060) | 3,35 (.132) |
| DB | Front | 44,27 (1.743) | 22,14 (.872) | 47,04 (1.852) | 23,52 (.926) | 13,03 (.513) | 6,52 (.257) | 3,04 (.120) | 1,52 (.060) | 2,10 (.083) |
| | Rear | 42,51 (1.674) | 21,25 (.837) | 47,04 (1.852) | 23,52 (.926) | 11,40 (.449) | 5,71 (.225) | 3,04 (.120) | 1,52 (.060) | 3,35 (.132) |
| DC | Front | 60,73 (2.391) | 30,37 (1.196) | 63,50 (2.500) | 31,75 (1.250) | 13,03 (.513) | 6,52 (.257) | 3,04 (.120) | 1,52 (.060) | 2,10 (.083) |
| | Rear | 59,08 (2.326) | 29,54 (1.163) | 63,50 (2.500) | 31,75 (1.250) | 11,40 (.449) | 5,71 (.225) | 3,04 (.120) | 1,52 (.060) | 3,35 (.132) |
| DD | Front | 58,34 (2.297) | 29,18 (1.149) | 61,11 (2.406) | 30,55 (1.203) | 15,82 (.623) | 7,92 (.312) | 3,04 (.120) | 1,52 (.060) | 2,10 (.083) |
| | Rear | 56,33 (2.218) | 28,16 (1.109) | 61,11 (2.406) | 30,55 (1.203) | 14,09 (.555) | 7,06 (.278) | 3,04 (.120) | 1,52 (.060) | 3,35 (.132) |

Dual Float Mount Shell

| Shell Size | Mounting Method | A ±0,13 (.005) | B ±0,13 (.005) | C ±0,13 (.005) | D ±0,13 (.005) | E ±0,13 (.005) | F ±0,13 (.005) | G ±0,05 (.002) | H ±0,05 (.002) | J ±0,05 (.002) |
|------------|-----------------|-------------------|-------------------|-------------------|-------------------|-------------------|-------------------|-------------------|-------------------|-------------------|
| DE | Front | 23,01 (.906) | 11,50 (.453) | 24,99 (.984) | 12,49 (.492) | 13,84 (.545) | 6,93 (.273) | 2,23 (.088) | 1,11 (.044) | 2,10 (.083) |
| | Rear | 21,28 (.838) | 10,64 (.419) | 24,99 (.984) | 12,49 (.492) | 12,21 (.481) | 6,12 (.241) | 2,23 (.088) | 1,11 (.044) | 3,35 (.132) |
| DA | Front | 31,34 (1.234) | 15,67 (.617) | 33,32 (1.312) | 16,66 (.656) | 13,84 (.545) | 6,93 (.273) | 2,23 (.088) | 1,11 (.044) | 2,10 (.083) |
| | Rear | 29,61 (1.166) | 14,80 (.583) | 33,32 (1.312) | 16,66 (.656) | 12,21 (.481) | 6,12 (.241) | 2,23 (.088) | 1,11 (.044) | 3,35 (.132) |
| DB | Front | 45,08 (1.775) | 22,55 (.888) | 47,04 (1.852) | 23,52 (.926) | 13,84 (.545) | 6,93 (.273) | 2,23 (.088) | 1,11 (.044) | 2,10 (.083) |
| | Rear | 43,33 (1.706) | 21,66 (.853) | 47,04 (1.852) | 23,52 (.926) | 12,21 (.481) | 6,12 (.241) | 2,23 (.088) | 1,11 (.044) | 3,35 (.132) |
| DC | Front | 61,54 (2.423) | 30,78 (1.212) | 63,50 (2.500) | 31,75 (1.250) | 13,84 (.545) | 6,93 (.273) | 2,23 (.088) | 1,11 (.044) | 2,10 (.083) |
| | Rear | 59,79 (2.354) | 29,89 (1.177) | 63,50 (2.500) | 31,75 (1.250) | 12,21 (.481) | 6,12 (.241) | 2,23 (.088) | 1,11 (.044) | 3,35 (.132) |
| DD | Front | 59,15 (2.329) | 29,59 (1.165) | 61,11 (2.406) | 30,55 (1.203) | 16,63 (.655) | 8,33 (.328) | 2,23 (.088) | 1,11 (.044) | 2,10 (.083) |
| | Rear | 57,15 (2.250) | 28,57 (1.125) | 61,11 (2.406) | 30,55 (1.203) | 14,90 (.587) | 7,46 (.294) | 2,23 (.088) | 1,11 (.044) | 3,35 (.132) |

Plug Contact Cavity Arrangements — Combo D®

Face View Pin Insert



Shell Size
Contact Arrangement
No. of Size 20 Cavities
No. of Size 8 Cavities

E
5W1
4 #20
1 #8



A
3W3
0 #20
3 #8



A
3WK3
0
3



A
7W2
5 #20
2 #8



A
11W1
10 #20
1 #8



Shell Size
Contact Arrangement
No. of Size 20 Cavities
No. of Size 8 Cavities

B
5W5
0 #20
5 #8



B
9W4
5 #20
4 #8



B
13W3
10 #20
3 #8



Shell Size
Contact Arrangement
No. of Size 20 Cavities
No. of Size 8 Cavities

B
17W2
15 #20
2 #8



B
21W1
20 #20
1 #8



Shell Size
Contact Arrangement
No. of Size 20 Cavities
No. of Size 8 Cavities

C
8W8
0 #20
8 #8



C
13W6
7 #20
6 #8



C
17W5
12 #20
5 #8



Shell Size
Contact Arrangement
No. of Size 20 Cavities
No. of Size 8 Cavities

C
21WA4
17 #20
4 #8



C
25W3
22 #20
3 #8

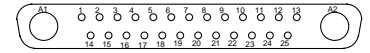

C
27W2
25 #20
2 #8



Shell Size
Contact Arrangement
No. of Size 20 Cavities
No. of Size 8 Cavities

D
24W7
17 #20
7 #8



D
36W4
32 #20
4 #8



Shell Size
Contact Arrangement
No. of Size 20 Cavities
No. of Size 8 Cavities

D
43W2
41 #20
2 #8



D
47W1
46 #20
1 #8

Note: Size 8 Cavities will Accommodate Removable Coaxial, High Power and/or High Voltage Contacts.

Receptacle Contact Cavity Arrangements — Combo D®

Face View Socket Insert



Shell Size
Contact Arrangement
No. of Size 20 Cavities
No. of Size 8 Cavities



Shell Size
Contact Arrangement
No. of Size 20 Cavities
No. of Size 8 Cavities



Shell Size
Contact Arrangement
No. of Size 20 Cavities
No. of Size 8 Cavities



Shell Size
Contact Arrangement
No. of Size 20 Cavities
No. of Size 8 Cavities



Shell Size
Contact Arrangement
No. of Size 20 Cavities
No. of Size 8 Cavities



Shell Size
Contact Arrangement
No. of Size 20 Cavities
No. of Size 8 Cavities

Shell Size
Contact Arrangement
No. of Size 20 Cavities
No. of Size 8 Cavities



Shell Size
Contact Arrangement
No. of Size 20 Cavities
No. of Size 8 Cavities



Shell Size
Contact Arrangement
No. of Size 20 Cavities
No. of Size 8 Cavities



Shell Size
Contact Arrangement
No. of Size 20 Cavities
No. of Size 8 Cavities

Shell Size
Contact Arrangement
No. of Size 20 Cavities
No. of Size 8 Cavities



Shell Size
Contact Arrangement
No. of Size 20 Cavities
No. of Size 8 Cavities



Shell Size
Contact Arrangement
No. of Size 20 Cavities
No. of Size 8 Cavities

Shell Size
Contact Arrangement
No. of Size 20 Cavities
No. of Size 8 Cavities



Shell Size
Contact Arrangement
No. of Size 20 Cavities
No. of Size 8 Cavities



Shell Size
Contact Arrangement
No. of Size 20 Cavities
No. of Size 8 Cavities



Shell Size
Contact Arrangement
No. of Size 20 Cavities
No. of Size 8 Cavities

Shell Size
Contact Arrangement
No. of Size 20 Cavities
No. of Size 8 Cavities



Shell Size
Contact Arrangement
No. of Size 20 Cavities
No. of Size 8 Cavities



Shell Size
Contact Arrangement
No. of Size 20 Cavities
No. of Size 8 Cavities



Shell Size
Contact Arrangement
No. of Size 20 Contacts
No. of Size 8 Contacts

Shell Size
Contact Arrangement
No. of Size 20 Contacts
No. of Size 8 Contacts



Shell Size
Contact Arrangement
No. of Size 20 Contacts
No. of Size 8 Contacts



Shell Size
Contact Arrangement
No. of Size 20 Cavities
No. of Size 8 Cavities

Shell Size
Contact Arrangement
No. of Size 20 Cavities
No. of Size 8 Cavities



Shell Size
Contact Arrangement
No. of Size 20 Cavities
No. of Size 8 Cavities

Note: Size 8 Cavities will Accommodate Removable Coaxial, High Power and/or High Voltage Contacts.

Plug Contact Cavity Arrangements

Face View Pin Insert



Shell Size
Contact Arrangement
Contact Size

E
9
#20



A
15
#20



B
25
#20



Shell Size
Contact Arrangement
Contact Size

C
37
#20



D
50
#20

Receptacle Contact Cavity Arrangements

Face View Socket Insert



Shell Size
Contact Arrangement
Contact Size

E
9
#20



A
15
#20



B
25
#20



Shell Size
Contact Arrangement
Contact Size

C
37
#20



D
50
#20

Pushfit/Boardlock — Standard

Straight (Z)

90° (C)



Pushfit/Boardlock — European

Straight (-146)

90° (-146)



Alternate 50 Ohm Coaxial Configuration

Straight (X)

90° (X)

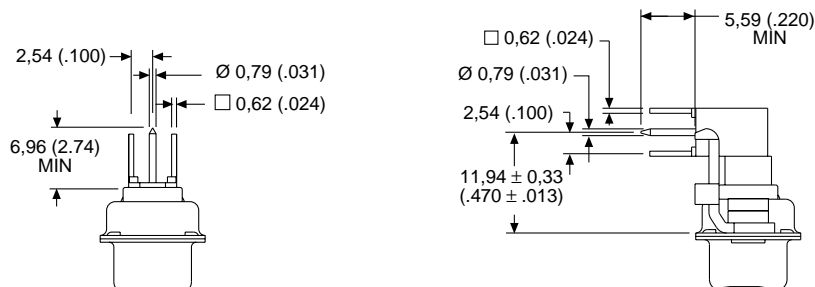

Hardware Views (Standard)

Through Hole (Eyelet)



Tab Shells (K)



Clinch Nut (E)



Dimensions — Plug

| Shell Size | $\pm 0,317 (.0125)$ | $\pm 0,25 (.010)$ |
|------------|---------------------|-------------------|
| DE | 1,206 (.0475) | — |
| DA | 1,206 (.0475) | — |
| DB | — | 1,52 (.060) |
| DC | — | 1,52 (.060) |
| DD | — | 1,52 (.060) |

Dual Float Mount (Y)



Dimensions — Receptacle

| Shell Size | $\pm 0,318 (.0125)$ |
|------------|---------------------|
| DE | 1,206 (.0475) |
| DA | 1,206 (.0475) |
| DB | 1,206 (.0475) |
| DC | 1,206 (.0475) |
| DD | 1,206 (.0475) |

Alternate Bracket Configuration

Supplied with connectors without boardlocks.

Standard Footprint (P)

European Footprint (P)

Dimensions

| Shell Size | $\pm 0,25 (.010)$ | $\pm 0,25 (.010)$ |
|----------------|-------------------|-------------------|
| DE, DA, DB, DC | 11,61 (.457) | 12,78 (.503) |
| DD | 12,78 (.503) | 13,95 (.549) |



Hardware Views (European)

Through Hole



Clinch Nut (X/E)



Plastic Bracket with Bushing (1A5N)



Plastic Bracket with Captive Nut (1ATN/1AVN)



Plastic Bracket with Post (1APN/1A6N)



Metal Bracket with Bushing (1AFN)



Metal Bracket with Captive Nut (1A9N/1A7N)



Metal Bracket with Post (1AHN/1A8N)



PCB Hole Pattern — Standard

Coaxial 90° — Plug



Shell Size **E**
 Contact Arrangement **5W1**
 No. of Size 20 Cavities **4 #20**
 No. of Size 8 Cavities **1 #8**



Shell Size **A**
 Contact Arrangement **3W3**
 No. of Size 20 Cavities **0 #20**
 No. of Size 8 Cavities **3 #8**



Shell Size **A**
 Contact Arrangement **7W2**
 No. of Size 20 Cavities **5 #20**
 No. of Size 8 Cavities **2 #8**



Shell Size **A**
 Contact Arrangement **11W1**
 No. of Size 20 Cavities **10 #20**
 No. of Size 8 Cavities **1 #8**



Shell Size **B**
 Contact Arrangement **5W5**
 No. of Size 20 Cavities **0 #20**
 No. of Size 8 Cavities **5 #8**



Shell Size **B**
 Contact Arrangement **9W4**
 No. of Size 20 Cavities **5 #20**
 No. of Size 8 Cavities **4 #8**



Shell Size **B**
 Contact Arrangement **13W3**
 No. of Size 20 Cavities **10 #20**
 No. of Size 8 Cavities **3 #8**



Shell Size **B**
 Contact Arrangement **17W2**
 No. of Size 20 Cavities **15 #20**
 No. of Size 8 Cavities **2 #8**



Shell Size **B**
 Contact Arrangement **21W1**
 No. of Size 20 Cavities **20 #20**
 No. of Size 8 Cavities **1 #8**

| Signal Contact Ø | Recommended PCB Hole Ø |
|---------------------|------------------------|
| 0,76 (.030) | 1,14 (.045) |
| Mounting Type | Recommended PCB Hole Ø |
| Without Boardlock | 3,05 (.120) |
| With Boardlock | 3,10 (.122) |
| Size 8 Contact Type | Recommended PCB Hole Ø |
| Coaxial (C or X) | 1,14 (.045) |

PCB Hole Pattern — Standard

Coaxial 90° — Plug



Shell Size
Contact Arrangement
No. of Size 20 Cavities
No. of Size 8 Cavities

C
8W8
0 #20
8 #8

C
13W6
7 #20
6 #8



Shell Size
Contact Arrangement
No. of Size 20 Cavities
No. of Size 8 Cavities

C
17W5
12 #20
5 #8

C
21WA4
17 #20
4 #8



Shell Size
Contact Arrangement
No. of Size 20 Cavities
No. of Size 8 Cavities

C
25W3
22 #20
3 #8

C
27W2
25 #20
2 #8

| Signal Contact Ø | Recommended PCB Hole Ø |
|---------------------|------------------------|
| 0,76 (.030) | 1,14 (.045) |
| Mounting Type | Recommended PCB Hole Ø |
| Without Boardlock | 3,05 (.120) |
| With Boardlock | 3,10 (.122) |
| Size 8 Contact Type | Recommended PCB Hole Ø |
| Coaxial (C or X) | 1,14 (.045) |

Reader's Resource

PCB Hole Pattern — Standard

Coaxial 90° — Plug



Shell Size D
 Contact Arrangement 24W7
 No. of Size 20 Cavities 17 #20
 No. of Size 8 Cavities 7 #8



Shell Size D
 Contact Arrangement 36W4
 No. of Size 20 Cavities 32 #20
 No. of Size 8 Cavities 4 #8



Shell Size D
 Contact Arrangement 43W2
 No. of Size 20 Cavities 41 #20
 No. of Size 8 Cavities 2 #20



Shell Size D
 Contact Arrangement 47W1
 No. of Size 20 Cavities 46 #20
 No. of Size 8 Cavities 1 #20

Reader's Resource

| | |
|---------------------|------------------------|
| Signal Contact Ø | Recommended PCB Hole Ø |
| 0,76 (.030) | 1,14 (.045) |
| Mounting Type | Recommended PCB Hole Ø |
| Without Boardlock | 3,05 (.120) |
| With Boardlock | 3,10 (.122) |
| Size 8 Contact Type | Recommended PCB Hole Ø |
| Coaxial (C or X) | 1,14 (.045) |

PCB Hole Pattern — Standard

Coaxial 90° — Receptacle



Shell Size **E**
 Contact Arrangement **5W1**
 No. of Size 20 Cavities **4 #20**
 No. of Size 8 Cavities **1 #8**



Shell Size **A**
 Contact Arrangement **3W3**
 No. of Size 20 Cavities **0 #20**
 No. of Size 8 Cavities **3 #8**



Shell Size **A**
 Contact Arrangement **7W2**
 No. of Size 20 Cavities **5 #20**
 No. of Size 8 Cavities **2 #8**



Shell Size **A**
 Contact Arrangement **11W1**
 No. of Size 20 Cavities **10 #20**
 No. of Size 8 Cavities **1 #8**



Shell Size **B**
 Contact Arrangement **5W5**
 No. of Size 20 Cavities **0 #20**
 No. of Size 8 Cavities **5 #8**



Shell Size **B**
 Contact Arrangement **9W4**
 No. of Size 20 Cavities **5 #20**
 No. of Size 8 Cavities **4 #8**



Shell Size **B**
 Contact Arrangement **13W3**
 No. of Size 20 Cavities **10 #20**
 No. of Size 8 Cavities **3 #8**



Shell Size **B**
 Contact Arrangement **17W2**
 No. of Size 20 Cavities **15 #20**
 No. of Size 8 Cavities **2 #8**



Shell Size **B**
 Contact Arrangement **21W1**
 No. of Size 20 Cavities **20 #20**
 No. of Size 8 Cavities **1 #8**

| Signal Contact Ø | Recommended PCB Hole Ø |
|---------------------|------------------------|
| 0,76 (.030) | 1,14 (.045) |
| Mounting Type | Recommended PCB Hole Ø |
| Without Boardlock | 3,05 (.120) |
| With Boardlock | 3,10 (.122) |
| Size 8 Contact Type | Recommended PCB Hole Ø |
| Coaxial (C or X) | 1,14 (.045) |

PCB Hole Pattern — Standard

Coaxial 90° — Receptacle



Shell Size
Contact Arrangement
No. of Size 20 Cavities
No. of Size 8 Cavities

C
8W8
0 #20
8 #8

C
13W6
7 #20
6 #8

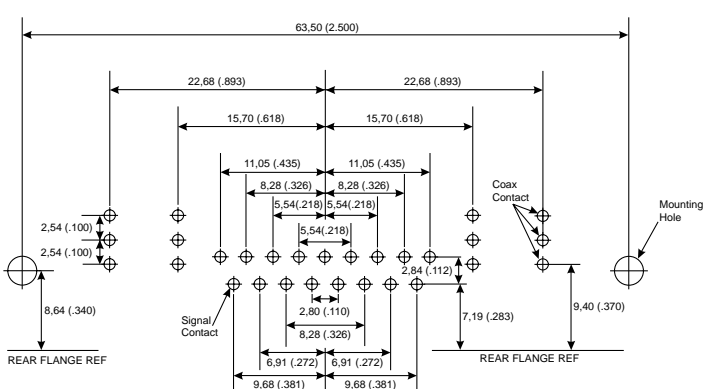

Shell Size
Contact Arrangement
No. of Size 20 Cavities
No. of Size 8 Cavities

C
17W5
12 #20
5 #8

C
21WA4
17 #20
4 #8

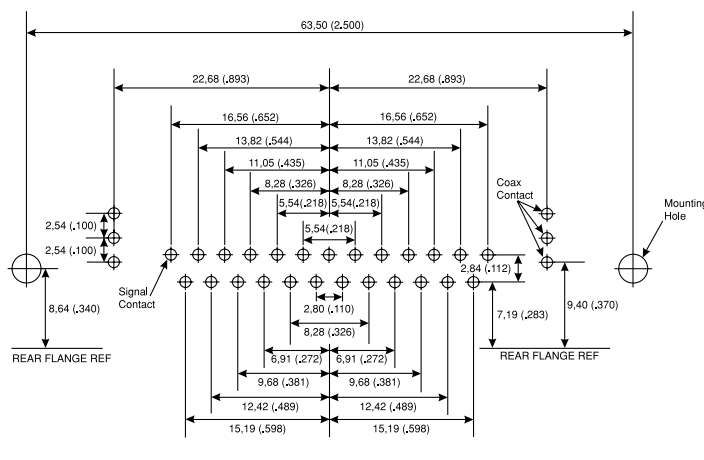

Shell Size
Contact Arrangement
No. of Size 20 Cavities
No. of Size 8 Cavities

C
25W3
22 #20
3 #8

C
27W2
25 #20
2 #8

| Signal Contact Ø | Recommended PCB Hole Ø |
|---------------------|------------------------|
| 0,76 (.030) | 1,14 (.045) |
| Mounting Type | Recommended PCB Hole Ø |
| Without Boardlock | 3,05 (.120) |
| With Boardlock | 3,10 (.122) |
| Size 8 Contact Type | Recommended PCB Hole Ø |
| Coaxial (C or X) | 1,14 (.045) |

PCB Hole Pattern — Standard

Coaxial 90° — Receptacle



Shell Size
Contact Arrangement
No. of Size 20 Cavities
No. of Size 8 Cavities

D
24W7
17 #20
7 #8



D
36W4
32 #20
4 #8



Shell Size
Contact Arrangement
No. of Size 20 Cavities
No. of Size 8 Cavities

D
43W2
43 #20
2 #8



D
47W1
46 #20
1 #8

| | |
|---------------------|------------------------|
| Signal Contact Ø | Recommended PCB Hole Ø |
| 0,76 (.030) | 1,14 (.045) |
| Mounting Type | Recommended PCB Hole Ø |
| Without Boardlock | 3,05 (.120) |
| With Boardlock | 3,10 (.122) |
| Size 8 Contact Type | Recommended PCB Hole Ø |
| Coaxial (C or X) | 1,14 (.045) |

PCB Hole Pattern — European

Coaxial 90° — Plug



Shell Size
Contact Arrangement
No. of Size 20 Cavities
No. of Size 8 Cavities

E
5W1
4 #20
1 #8



A
3W3
0 #20
3 #8



A
7W2
5 #20
2 #8



Shell Size
Contact Arrangement
No. of Size 20 Cavities
No. of Size 8 Cavities

A
11W1
10 #20
1 #8



B
5W5
0 #20
5 #8



Shell Size
Contact Arrangement
No. of Size 20 Cavities
No. of Size 8 Cavities

B
9W4
5 #20
4 #8



B
13W3
10 #20
3 #8



Shell Size
Contact Arrangement
No. of Size 20 Cavities
No. of Size 8 Cavities

B
17W2
15 #20
2 #8



B
21W1
20 #20
1 #8

| Signal Contact Ø | Recommended PCB Hole Ø |
|---------------------|------------------------|
| 0,60 (.024) | 1,00 (.039) |
| Mounting Type | Recommended PCB Hole Ø |
| Without Boardlock | 3,05 (.120) |
| With Boardlock | 3,10 (.122) |
| Size 8 Contact Type | Recommended PCB Hole Ø |
| Coaxial (C or X) | 1,14 (.045) |

PCB Hole Pattern — European

Coaxial 90° — Plug



Shell Size
Contact Arrangement
No. of Size 20 Cavities
No. of Size 8 Cavities

C
8W8
0 #20
8 #8

C
13W6
7 #20
6 #8



Shell Size
Contact Arrangement
No. of Size 20 Cavities
No. of Size 8 Cavities

C
17W5
12 #20
5 #8

C
21WA4
17 #20
4 #8



Shell Size
Contact Arrangement
No. of Size 20 Cavities
No. of Size 8 Cavities

C
25W3
22 #20
3 #8



C
27W2
25 #20
2 #8

| Signal Contact Ø | Recommended PCB Hole Ø |
|---------------------|------------------------|
| 0,60 (.024) | 1,00 (.039) |
| Mounting Type | Recommended PCB Hole Ø |
| Without Boardlock | 3,05 (.120) |
| With Boardlock | 3,10 (.122) |
| Size 8 Contact Type | Recommended PCB Hole Ø |
| Coaxial (C or X) | 1,14 (.045) |

PCB Hole Pattern — European

Coaxial 90° — Receptacle



Shell Size **E**
 Contact Arrangement **5W1**
 No. of Size 20 Cavities **4 #20**
 No. of Size 8 Cavities **1 #8**



Shell Size **A**
 Contact Arrangement **3W3**
 No. of Size 20 Cavities **0 #20**
 No. of Size 8 Cavities **3 #8**



Shell Size **A**
 Contact Arrangement **7W2**
 No. of Size 20 Cavities **5 #20**
 No. of Size 8 Cavities **2 #8**



Shell Size **A**
 Contact Arrangement **11W1**
 No. of Size 20 Cavities **10 #20**
 No. of Size 8 Cavities **1 #8**



Shell Size **B**
 Contact Arrangement **5W5**
 No. of Size 20 Cavities **0 #20**
 No. of Size 8 Cavities **5 #8**



Shell Size **B**
 Contact Arrangement **9W4**
 No. of Size 20 Cavities **5 #20**
 No. of Size 8 Cavities **4 #8**



Shell Size **B**
 Contact Arrangement **13W3**
 No. of Size 20 Cavities **10 #20**
 No. of Size 8 Cavities **3 #8**



Shell Size **B**
 Contact Arrangement **17W2**
 No. of Size 20 Cavities **15 #20**
 No. of Size 8 Cavities **2 #8**



Shell Size **B**
 Contact Arrangement **21W1**
 No. of Size 20 Cavities **20 #20**
 No. of Size 8 Cavities **1 #8**

| | |
|---------------------|------------------------|
| Signal Contact Ø | Recommended PCB Hole Ø |
| 0,60 (.024) | 1,00 (.039) |
| Mounting Type | Recommended PCB Hole Ø |
| Without Boardlock | 3,05 (.120) |
| With Boardlock | 3,10 (.122) |
| Size 8 Contact Type | Recommended PCB Hole Ø |
| Coaxial (C or X) | 1,14 (.045) |

Reader's Resource

PCB Hole Pattern — European

Coaxial 90° — Receptacle



Shell Size
Contact Arrangement
No. of Size 20 Cavities
No. of Size 8 Cavities

C
8W8
0 #20
8 #8

C
13W6
7 #20
6 #8



Shell Size
Contact Arrangement
No. of Size 20 Cavities
No. of Size 8 Cavities

C
17W5
12 #20
5 #8

C
21WA4
17 #20
4 #8



Shell Size
Contact Arrangement
No. of Size 20 Cavities
No. of Size 8 Cavities

C
25W3
22 #20
3 #8

C
27W2
25 #20
2 #8

| | |
|---------------------|------------------------|
| Signal Contact Ø | Recommended PCB Hole Ø |
| 0,60 (.024) | 1,00 (.039) |
| Mounting Type | Recommended PCB Hole Ø |
| Without Boardlock | 3,05 (.120) |
| With Boardlock | 3,10 (.122) |
| Size 8 Contact Type | Recommended PCB Hole Ø |
| Coaxial (C or X) | 1,14 (.045) |

PCB Hole Pattern — Standard/European

Coaxial Straight — Plug



Shell Size **E**
 Contact Arrangement **5W1**
 No. of Size 20 Cavities **4 #20**
 No. of Size 8 Cavities **1 #8**



Shell Size **A**
 Contact Arrangement **3W3**
 No. of Size 20 Cavities **0 #20**
 No. of Size 8 Cavities **3 #8**



Shell Size **A**
 Contact Arrangement **7W2**
 No. of Size 20 Cavities **5 #20**
 No. of Size 8 Cavities **2 #8**



Shell Size **A**
 Contact Arrangement **11W1**
 No. of Size 20 Cavities **10 #20**
 No. of Size 8 Cavities **1 #8**



Shell Size **B**
 Contact Arrangement **5W5**
 No. of Size 20 Cavities **0 #20**
 No. of Size 8 Cavities **5 #8**



Shell Size **B**
 Contact Arrangement **9W4**
 No. of Size 20 Cavities **5 #20**
 No. of Size 8 Cavities **4 #8**



Shell Size **B**
 Contact Arrangement **13W3**
 No. of Size 20 Cavities **10 #20**
 No. of Size 8 Cavities **3 #8**



Shell Size **B**
 Contact Arrangement **17W2**
 No. of Size 20 Cavities **15 #20**
 No. of Size 8 Cavities **2 #8**



Shell Size **B**
 Contact Arrangement **21W1**
 No. of Size 20 Cavities **20 #20**
 No. of Size 8 Cavities **1 #8**

| Signal Contact Ø | Recommended PCB Hole Ø |
|---------------------|------------------------|
| 0,60 (.024) | 1,00 (.039) |
| 0,76 (.030) | 1,14 (.045) |
| Mounting Type | Recommended PCB Hole Ø |
| Without Boardlock | 3,05 (.120) |
| With Boardlock | 3,10 (.122) |
| Size 8 Contact Type | Recommended PCB Hole Ø |
| Coaxial (C or X) | 1,14 (.045) |

PCB Hole Pattern — Standard/European

Coaxial Straight — Plug



Shell Size
Contact Arrangement
No. of Size 20 Cavities
No. of Size 8 Cavities

C
8W8
0 #20
8 #8



C
13W6
7 #20
6 #8



Shell Size
Contact Arrangement
No. of Size 20 Cavities
No. of Size 8 Cavities

C
17W5
12 #20
5 #8



C
21WA4
17 #20
4 #8



Shell Size
Contact Arrangement
No. of Size 20 Cavities
No. of Size 8 Cavities

C
25W3
22 #20
3 #8



C
27W2
25 #20
2 #8

| Signal Contact Ø | Recommended PCB Hole Ø |
|---------------------|------------------------|
| 0,60 (.024) | 1,00 (.039) |
| 0,76 (.030) | 1,14 (.045) |
| Mounting Type | Recommended PCB Hole Ø |
| Without Boardlock | 3,05 (.120) |
| With Boardlock | 3,10 (.122) |
| Size 8 Contact Type | Recommended PCB Hole Ø |
| Coaxial (C or X) | 1,14 (.045) |

PCB Hole Pattern — Standard/European

Coaxial Straight — Plug



Shell Size
Contact Arrangement
No. of Size 20 Cavities
No. of Size 8 Cavities

D
24W7
17 #20
7 #8

D
36W4
32 #20
4 #8



Shell Size
Contact Arrangement
No. of Size 20 Cavities
No. of Size 8 Cavities

D
43W2
41 #20
2 #8

D
47W1
46 #20
1 #8

| Signal Contact Ø | Recommended PCB Hole Ø |
|---------------------|------------------------|
| 0,60 (.024) | 1,00 (.039) |
| 0,76 (.030) | 1,14 (.045) |
| Mounting Type | Recommended PCB Hole Ø |
| Without Boardlock | 3,05 (.120) |
| With Boardlock | 3,10 (.122) |
| Size 8 Contact Type | Recommended PCB Hole Ø |
| Coaxial (C or X) | 1,14 (.045) |

PCB Hole Pattern — Standard/European

Coaxial Straight — Receptacle



Shell Size
Contact Arrangement
No. of Size 20 Cavities
No. of Size 8 Cavities

E
5W1
4 #20
1 #8

A
3W3
0 #20
3 #8

A
7W2
5 #20
2 #8



Shell Size
Contact Arrangement
No. of Size 20 Cavities
No. of Size 8 Cavities

A
11W1
10 #20
1 #8

B
5W5
0 #20
5 #8



Shell Size
Contact Arrangement
No. of Size 20 Cavities
No. of Size 8 Cavities

B
9W4
5 #20
4 #8

B
13W3
10 #20
3 #8



Shell Size
Contact Arrangement
No. of Size 20 Cavities
No. of Size 8 Cavities

B
17W2
15 #20
2 #8

B
21W1
20 #20
1 #8

| Signal Contact Ø | Recommended PCB Hole Ø |
|---------------------|------------------------|
| 0,60 (.024) | 1,00 (.039) |
| 0,76 (.030) | 1,14 (.045) |
| Mounting Type | Recommended PCB Hole Ø |
| Without Boardlock | 3,05 (.120) |
| With Boardlock | 3,10 (.122) |
| Size 8 Contact Type | Recommended PCB Hole Ø |
| Coaxial (C or X) | 1,14 (.045) |

Reader's Resource

PCB Hole Pattern — Standard/European

Coaxial Straight — Receptacle



Shell Size
Contact Arrangement
No. of Size 20 Cavities
No. of Size 8 Cavities

C
8W8
0 #20
8 #8



C
13W6
7 #20
6 #8



Shell Size
Contact Arrangement
No. of Size 20 Cavities
No. of Size 8 Cavities

C
17W5
12 #20
5 #8



C
21WA4
17 #20
4 #8



Shell Size
Contact Arrangement
No. of Size 20 Cavities
No. of Size 8 Cavities

C
25W3
22 #20
3 #8



C
27W2
25 #20
2 #8

| Signal Contact Ø | Recommended PCB Hole Ø |
|---------------------|------------------------|
| 0,60 (.024) | 1,00 (.039) |
| 0,76 (.030) | 1,14 (.045) |
| Mounting Type | Recommended PCB Hole Ø |
| Without Boardlock | 3,05 (.120) |
| With Boardlock | 3,10 (.122) |
| Size 8 Contact Type | Recommended PCB Hole Ø |
| Coaxial (C or X) | 1,14 (.045) |

PCB Hole Pattern — Standard/European

Coaxial Straight — Receptacle



Shell Size
Contact Arrangement
No. of Size 20 Cavities
No. of Size 8 Cavities

D
24W7
17 #20
7 #8



D
36W4
32 #20
4 #8



Shell Size
Contact Arrangement
No. of Size 20 Cavities
No. of Size 8 Cavities

D
43W2
41 #20
2 #8



D
47W1
46 #20
1 #8

| Signal Contact Ø | Recommended PCB Hole Ø |
|---------------------|------------------------|
| 0,60 (.024) | 1,00 (.039) |
| 0,76 (.030) | 1,14 (.045) |
| Mounting Type | Recommended PCB Hole Ø |
| Without Boardlock | 3,05 (.120) |
| With Boardlock | 3,10 (.122) |
| Size 8 Contact Type | Recommended PCB Hole Ø |
| Coaxial (C or X) | 1,14 (.045) |

PCB Hole Pattern — Standard

High Power 90° — Plug



Shell Size
Contact Arrangement
No. of Size 20 Cavities
No. of Size 8 Cavities

E
5W1
4 #20
1 #8



A
3W3
0 #20
3 #8



A
7W2
5 #20
2 #8



Shell Size
Contact Arrangement
No. of Size 20 Cavities
No. of Size 8 Cavities

A
11W1
10 #20
1 #8



B
5W5
0 #20
5 #8



Shell Size
Contact Arrangement
No. of Size 20 Cavities
No. of Size 8 Cavities

B
9W4
5 #20
4 #8



B
13W3
10 #20
3 #8



Shell Size
Contact Arrangement
No. of Size 20 Cavities
No. of Size 8 Cavities

B
17W2
15 #20
2 #8



B
21W1
20 #20
1 #8

| Signal Contact Ø | Recommended PCB Hole Ø |
|---------------------|------------------------|
| 0,76 (.030) | 1,14 (.045) |
| Mounting Type | Recommended PCB Hole Ø |
| Without Boardlock | 3,05 (.120) |
| With Boardlock | 3,10 (.122) |
| Size 8 Contact Type | Recommended PCB Hole Ø |
| High Power (H) | 3,56 (.140) |

PCB Hole Pattern — Standard

High Power 90° — Plug



Shell Size
Contact Arrangement
No. of Size 20 Cavities
No. of Size 8 Cavities

C
8W8
0 #20
8 #8

C
13W6
7 #20
6 #8



Shell Size
Contact Arrangement
No. of Size 20 Cavities
No. of Size 8 Cavities

C
17W5
12 #20
5 #8



C
21WA4
17 #20
4 #8



Shell Size
Contact Arrangement
No. of Size 20 Cavities
No. of Size 8 Cavities

C
25W3
22 #20
3 #8



C
27W2
25 #20
2 #8

| Signal Contact Ø | Recommended PCB Hole Ø |
|---------------------|------------------------|
| 0,76 (.030) | 1,14 (.045) |
| Mounting Type | Recommended PCB Hole Ø |
| Without Boardlock | 3,05 (.120) |
| With Boardlock | 3,10 (.122) |
| Size 8 Contact Type | Recommended PCB Hole Ø |
| High Power (H) | 3,56 (.140) |

PCB Hole Pattern — Standard

High Power 90° — Plug



Shell Size D
 Contact Arrangement 24W7
 No. of Size 20 Cavities 17 #20
 No. of Size 8 Cavities 7 #8

Shell Size D
 Contact Arrangement 36W4
 No. of Size 20 Cavities 32 #20
 No. of Size 8 Cavities 4 #8



Shell Size D
 Contact Arrangement 43W2
 No. of Size 20 Cavities 41 #20
 No. of Size 8 Cavities 2 #8

Shell Size D
 Contact Arrangement 47W1
 No. of Size 20 Cavities 46 #20
 No. of Size 8 Cavities 1 #8

Reader's Resource

| | |
|---------------------|------------------------|
| Signal Contact Ø | Recommended PCB Hole Ø |
| 0,76 (.030) | 1,14 (.045) |
| Mounting Type | Recommended PCB Hole Ø |
| Without Boardlock | 3,05 (.120) |
| With Boardlock | 3,10 (.122) |
| Size 8 Contact Type | Recommended PCB Hole Ø |
| High Power (H) | 3,56 (.140) |

PCB Hole Pattern — Standard

High Power 90° — Receptacle



Shell Size
Contact Arrangement
No. of Size 20 Cavities
No. of Size 8 Cavities

E
5W1
4 #20
1 #8



A
3W3
0 #20
3 #8



A
7W2
5 #20
2 #8



Shell Size
Contact Arrangement
No. of Size 20 Cavities
No. of Size 8 Cavities

A
11W1
10 #20
1 #8



B
5W5
0 #20
5 #8



Shell Size
Contact Arrangement
No. of Size 20 Cavities
No. of Size 8 Cavities

B
9W4
5 #20
4 #8



B
13W3
10 #20
3 #8



Shell Size
Contact Arrangement
No. of Size 20 Cavities
No. of Size 8 Cavities

B
17W2
15 #20
2 #8



B
21W1
20 #20
1 #8

| Signal Contact Ø | Recommended PCB Hole Ø |
|---------------------|------------------------|
| 0,76 (.030) | 1,14 (.045) |
| Mounting Type | Recommended PCB Hole Ø |
| Without Boardlock | 3,05 (.120) |
| With Boardlock | 3,10 (.122) |
| Size 8 Contact Type | Recommended PCB Hole Ø |
| High Power (H) | 3,56 (.140) |

PCB Hole Pattern — Standard

High Power 90° — Receptacle



Shell Size
Contact Arrangement
No. of Size 20 Cavities
No. of Size 8 Cavities

C
8W8
0 #20
8 #8

C
13W6
7 #20
6 #8



Shell Size
Contact Arrangement
No. of Size 20 Cavities
No. of Size 8 Cavities

C
17W5
12 #20
5 #8



C
21WA4
17 #20
4 #8



Shell Size
Contact Arrangement
No. of Size 20 Cavities
No. of Size 8 Cavities

C
25W3
22 #20
3 #8



C
27W2
25 #20
2 #8

| Signal Contact Ø | Recommended PCB Hole Ø |
|---------------------|------------------------|
| 0,76 (.030) | 1,14 (.045) |
| Mounting Type | Recommended PCB Hole Ø |
| Without Boardlock | 3,05 (.120) |
| With Boardlock | 3,10 (.122) |
| Size 8 Contact Type | Recommended PCB Hole Ø |
| High Power (H) | 3,56 (.140) |

PCB Hole Pattern — Standard

High Power 90° — Receptacle



Shell Size
Contact Arrangement
No. of Size 20 Cavities
No. of Size 8 Cavities

D
24W7
17 #20
7 #8

D
36W4
32 #20
4 #8



Shell Size
Contact Arrangement
No. of Size 20 Cavities
No. of Size 8 Cavities

D
43W2
41 #20
2 #8



D
47W1
46 #20
1 #8

| Signal Contact Ø | Recommended PCB Hole Ø |
|---------------------|------------------------|
| 0,76 (.030) | 1,14 (.045) |
| Mounting Type | Recommended PCB Hole Ø |
| Without Boardlock | 3,05 (.120) |
| With Boardlock | 3,10 (.122) |
| Size 8 Contact Type | Recommended PCB Hole Ø |
| High Power (H) | 3,56 (.140) |

PCB Hole Pattern — European

High Power 90° — Plug



Shell Size
Contact Arrangement
No. of Size 20 Cavities
No. of Size 8 Cavities

E
5W1
4 #20
1 #8



A
3W3
0 #20
3 #8



A
7W2
5 #20
2 #8



Shell Size
Contact Arrangement
No. of Size 20 Cavities
No. of Size 8 Cavities

A
11W1
10 #20
1 #8



B
5W5
0 #20
5 #8



Shell Size
Contact Arrangement
No. of Size 20 Cavities
No. of Size 8 Cavities

B
9W4
5 #20
4 #8



B
13W3
10 #20
3 #8



Shell Size
Contact Arrangement
No. of Size 20 Cavities
No. of Size 8 Cavities

B
17W2
15 #20
2 #8



B
21W1
20 #20
1 #8

| Signal Contact Ø | Recommended PCB Hole Ø |
|---------------------|------------------------|
| 0,60 (.024) | 1,00 (.039) |
| Mounting Type | Recommended PCB Hole Ø |
| Without Boardlock | 3,05 (.120) |
| With Boardlock | 3,10 (.122) |
| Size 8 Contact Type | Recommended PCB Hole Ø |
| High Power (P) | 3,28 (.129) |

PCB Hole Pattern — European

High Power 90° — Plug



Shell Size
Contact Arrangement
No. of Size 20 Cavities
No. of Size 8 Cavities

C
8W8
0 #20
8 #8

C
13W6
7 #20
6 #8



Shell Size
Contact Arrangement
No. of Size 20 Cavities
No. of Size 8 Cavities

C
17W5
12 #20
5 #8

C
21WA4
17 #20
4 #8



Shell Size
Contact Arrangement
No. of Size 20 Cavities
No. of Size 8 Cavities

C
25W3
22 #20
3 #8

C
27W2
25 #20
2 #8

| | |
|---------------------|------------------------|
| Signal Contact Ø | Recommended PCB Hole Ø |
| 0,60 (.024) | 1,00 (.039) |
| Mounting Type | Recommended PCB Hole Ø |
| Without Boardlock | 3,05 (.120) |
| With Boardlock | 3,10 (.122) |
| Size 8 Contact Type | Recommended PCB Hole Ø |
| High Power (P) | 3,28 (.129) |

PCB Hole Pattern — European

High Power 90° — Receptacle



Shell Size
Contact Arrangement
No. of Size 20 Cavities
No. of Size 8 Cavities

E
5W1
4 #20
1 #8



A
3W3
0 #20
3 #8



A
7W2
5 #20
2 #8



Shell Size
Contact Arrangement
No. of Size 20 Cavities
No. of Size 8 Cavities

A
11W1
10 #20
1 #8



B
5W5
0 #20
5 #8



Shell Size
Contact Arrangement
No. of Size 20 Cavities
No. of Size 8 Cavities

B
9W4
5 #20
4 #8



B
13W3
10 #20
3 #8

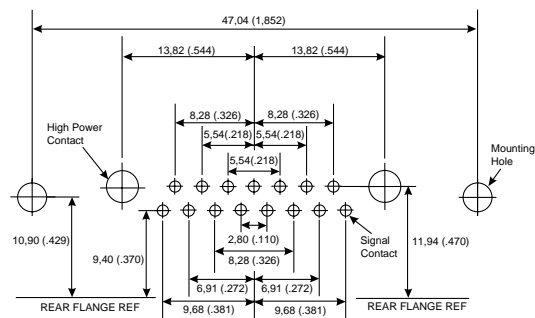

Shell Size
Contact Arrangement
No. of Size 20 Cavities
No. of Size 8 Cavities

B
17W2
15 #20
2 #8

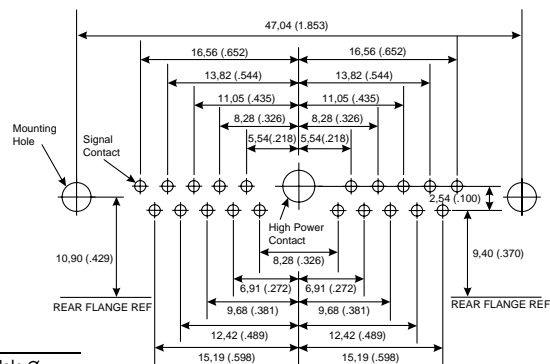

B
21W1
20 #20
1 #8

| | |
|---------------------|------------------------|
| Signal Contact Ø | Recommended PCB Hole Ø |
| 0,60 (.024) | 1,00 (.039) |
| Mounting Type | Recommended PCB Hole Ø |
| Without Boardlock | 3,05 (.120) |
| With Boardlock | 3,10 (.122) |
| Size 8 Contact Type | Recommended PCB Hole Ø |
| High Power (P) | 3,28 (.129) |

PCB Hole Pattern — European

High Power 90° — Receptacle

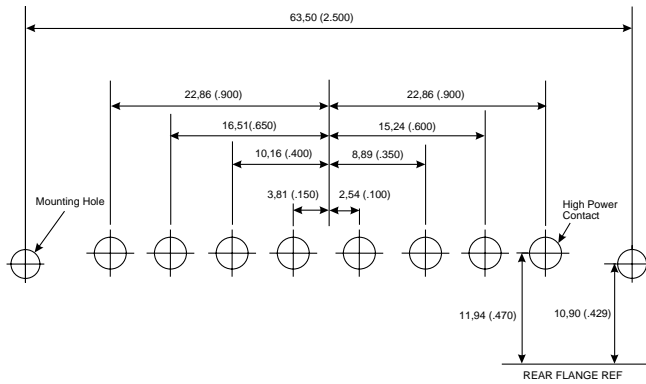

Shell Size
Contact Arrangement
No. of Size 20 Cavities
No. of Size 8 Cavities

C
8W8
0 #20
8 #8

C
13W6
7 #20
6 #8



Shell Size
Contact Arrangement
No. of Size 20 Cavities
No. of Size 8 Cavities

C
17W5
12 #20
5 #8

C
21WA4
17 #20
4 #8



Shell Size
Contact Arrangement
No. of Size 20 Cavities
No. of Size 8 Cavities

C
25W3
22 #20
3 #8

C
27W2
25 #20
2 #8

| Signal Contact Ø | Recommended PCB Hole Ø |
|---------------------|------------------------|
| 0,60 (.024) | 1,00 (.039) |
| Mounting Type | Recommended PCB Hole Ø |
| Without Boardlock | 3,05 (.120) |
| With Boardlock | 3,10 (.122) |
| Size 8 Contact Type | Recommended PCB Hole Ø |
| High Power (P) | 3,28 (.129) |

PCB Hole Pattern — Standard/European

High Power/Voltage Straight — Plug



Shell Size
Contact Arrangement
No. of Size 20 Cavities
No. of Size 8 Cavities

E
5W1
4 #20
1 #8



A
3W3
0 #20
3 #8



A
7W2
5 #20
2 #8



Shell Size
Contact Arrangement
No. of Size 20 Cavities
No. of Size 8 Cavities

A
11W1
10 #20
1 #8



B
5W5
0 #20
5 #8



Shell Size
Contact Arrangement
No. of Size 20 Cavities
No. of Size 8 Cavities

B
9W4
5 #20
4 #8



B
13W3
10 #20
3 #8



Shell Size
Contact Arrangement
No. of Size 20 Cavities
No. of Size 8 Cavities

B
17W2
15 #20
2 #8



B
21W1
20 #20
1 #8

| Signal Contact Ø | Recommended PCB Hole Ø |
|------------------|------------------------|
| 0,60 (.024) | 1,00 (.039) |
| 0,76 (.030) | 1,14 (.045) |

| Mounting Type | Recommended PCB Hole Ø |
|-------------------|------------------------|
| Without Boardlock | 3,05 (.120) |
| With Boardlock | 3,10 (.122) |

| Size 8 Contact Type | Recommended PCB Hole Ø |
|---------------------|------------------------|
| High Power (H) | 3,56 (.140) |
| High Voltage (V) | 1,96 (.077) |

PCB Hole Pattern — Standard/European

High Power/Voltage Straight — Plug



Shell Size
Contact Arrangement
No. of Size 20 Cavities
No. of Size 8 Cavities

C
8W8
0 #20
8 #8

C
13W6
7 #20
6 #8



Shell Size
Contact Arrangement
No. of Size 20 Cavities
No. of Size 8 Cavities

C
17W5
12 #20
5 #8

C
21WA4
17 #20
4 #8



Shell Size
Contact Arrangement
No. of Size 20 Cavities
No. of Size 8 Cavities

C
25W3
22 #20
3 #8

C
27W2
25 #20
2 #8

| Signal Contact Ø | Recommended PCB Hole Ø |
|---------------------|------------------------|
| 0.60 (.024) | 1.00 (.039) |
| 0.76 (.030) | 1.14 (.045) |
| Mounting Type | Recommended PCB Hole Ø |
| Without Boardlock | 3.05 (.120) |
| With Boardlock | 3.10 (.122) |
| Size 8 Contact Type | Recommended PCB Hole Ø |
| High Power (H) | 3.56 (.140) |
| High Voltage (V) | 1.96 (.077) |

PCB Hole Pattern — Standard/European

High Power/Voltage Straight — Plug



Shell Size
Contact Arrangement
No. of Size 20 Cavities
No. of Size 8 Cavities

D
24W7
17 #20
7 #8



D
36W4
32 #20
4 #8



Shell Size
Contact Arrangement
No. of Size 20 Cavities
No. of Size 8 Cavities

D
43W2
41 #20
2 #8



D
47W1
46 #20
1 #8

| Signal Contact Ø | Recommended PCB Hole Ø |
|---------------------|------------------------|
| 0,60 (.024) | 1,00 (.039) |
| 0,76 (.030) | 1,14 (.045) |
| Mounting Type | Recommended PCB Hole Ø |
| Without Boardlock | 3,05 (.120) |
| With Boardlock | 3,10 (.122) |
| Size 8 Contact Type | Recommended PCB Hole Ø |
| High Power (H) | 3,56 (.140) |
| High Voltage (V) | 1,96 (.077) |

PCB Hole Pattern — Standard/European High Power/Voltage Straight — Receptacle



Shell Size
Contact Arrangement
No. of Size 20 Cavities
No. of Size 8 Cavities

E
5W1
4 #20
1 #8



A
3W3
0 #20
3 #8



A
7W2
5 #20
2 #8



Shell Size
Contact Arrangement
No. of Size 20 Cavities
No. of Size 8 Cavities

A
11W1
10 #20
1 #8



B
5W5
0 #20
5 #8



Shell Size
Contact Arrangement
No. of Size 20 Cavities
No. of Size 8 Cavities

B
9W4
5 #20
4 #8



B
13W3
10 #20
3 #8



Shell Size
Contact Arrangement
No. of Size 20 Cavities
No. of Size 8 Cavities

B
17W2
15 #20
2 #8



B
21W1
20 #20
1 #8

| Signal Contact Ø | Recommended PCB Hole Ø |
|---------------------|------------------------|
| 0,60 (.024) | 1,00 (.039) |
| 0,76 (.030) | 1,14 (.045) |
| Mounting Type | Recommended PCB Hole Ø |
| Without Boardlock | 3,05 (.120) |
| With Boardlock | 3,10 (.122) |
| Size 8 Contact Type | Recommended PCB Hole Ø |
| High Power (H) | 3,56 (.140) |
| High Voltage (V) | 1,96 (.077) |

PCB Hole Pattern — Standard/European

High Power/Voltage Straight — Receptacle



Shell Size
Contact Arrangement
No. of Size 20 Cavities
No. of Size 8 Cavities

C
8W8
0 #20
8 #8



C
13W6
7 #20
6 #8



Shell Size
Contact Arrangement
No. of Size 20 Cavities
No. of Size 8 Cavities

C
17W5
12 #20
5 #8



C
21WA4
17 #20
4 #8



Shell Size
Contact Arrangement
No. of Size 20 Cavities
No. of Size 8 Cavities

C
25W3
22 #20
3 #8



C
27W2
25 #20
2 #8

| Signal Contact Ø | Recommended PCB Hole Ø |
|---------------------|------------------------|
| 0,60 (.024) | 1,00 (.039) |
| 0,76 (.030) | 1,14 (.045) |
| Mounting Type | Recommended PCB Hole Ø |
| Without Boardlock | 3,05 (.120) |
| With Boardlock | 3,10 (.122) |
| Size 8 Contact Type | Recommended PCB Hole Ø |
| High Power (H) | 3,56 (.140) |
| High Voltage (V) | 1,96 (.077) |

PCB Hole Pattern — Standard/European

High Power/Voltage Straight — Receptacle



Shell Size
Contact Arrangement
No. of Size 20 Cavities
No. of Size 8 Cavities

D
24W7
17 #20
7 #8

D
36W4
32 #20
4 #8



Shell Size
Contact Arrangement
No. of Size 20 Cavities
No. of Size 8 Cavities

D
43W2
41 #20
2 #8



Shell Size
Contact Arrangement
No. of Size 20 Cavities
No. of Size 8 Cavities

D
47W1
46 #20
1 #8

| Signal Contact Ø | Recommended PCB Hole Ø |
|---------------------|------------------------|
| 0,60 (.024) | 1,00 (.039) |
| 0,76 (.030) | 1,14 (.045) |
| Mounting Type | Recommended PCB Hole Ø |
| Without Boardlock | 3,05 (.120) |
| With Boardlock | 3,10 (.122) |
| Size 8 Contact Type | Recommended PCB Hole Ø |
| High Power (H) | 3,56 (.140) |
| High Voltage (V) | 1,96 (.077) |

PCB Hole Pattern — European

90° PC Tails — Plug



Shell Size
Contact Arrangement
No. of Size 20 Cavities
No. of Size 8 Cavities

E
5W1
4 #20
0 #8

A
7W2
5 #20
0 #8

A
11W1
10 #20
0 #8



Shell Size
Contact Arrangement
No. of Size 20 Cavities
No. of Size 8 Cavities

B
9W4
5 #20
0 #8



B
13W3
10 #20
0 #8



Shell Size
Contact Arrangement
No. of Size 20 Cavities
No. of Size 8 Cavities

B
17W2
15 #20
0 #8



B
21W1
20 #20
0 #8

| Signal Contact Ø | Recommended PCB Hole Ø |
|-------------------|------------------------|
| 0,60 (.024) | 1,00 (.039) |
| Mounting Type | Recommended PCB Hole Ø |
| Without Boardlock | 3,05 (.120) |
| With Boardlock | 3,10 (.122) |

PCB Hole Pattern — European

90° PC Tails — Plug



Shell Size
Contact Arrangement
No. of Size 20 Cavities
No. of Size 8 Cavities

C
13W6
7 #20
0 #8



Shell Size
Contact Arrangement
No. of Size 20 Cavities
No. of Size 8 Cavities

C
17W5
12 #20
0 #8



C
21WA4
17 #20
0 #8



Shell Size
Contact Arrangement
No. of Size 20 Cavities
No. of Size 8 Cavities

C
25W3
22 #20
0 #8



C
27W2
25 #20
0 #8

| Signal Contact Ø | Recommended PCB Hole Ø |
|-------------------|------------------------|
| 0,60 (.024) | 1,00 (.039) |
| Mounting Type | Recommended PCB Hole Ø |
| Without Boardlock | 3,05 (.120) |
| With Boardlock | 3,10 (.122) |

PCB Hole Pattern — European

90° PC Tails — Plug



Shell Size D
 Contact Arrangement 24W7
 No. of Size 20 Cavities 17 #20
 No. of Size 8 Cavities 0 #8

Shell Size D
 Contact Arrangement 36W4
 No. of Size 20 Cavities 32 #20
 No. of Size 8 Cavities 0 #8

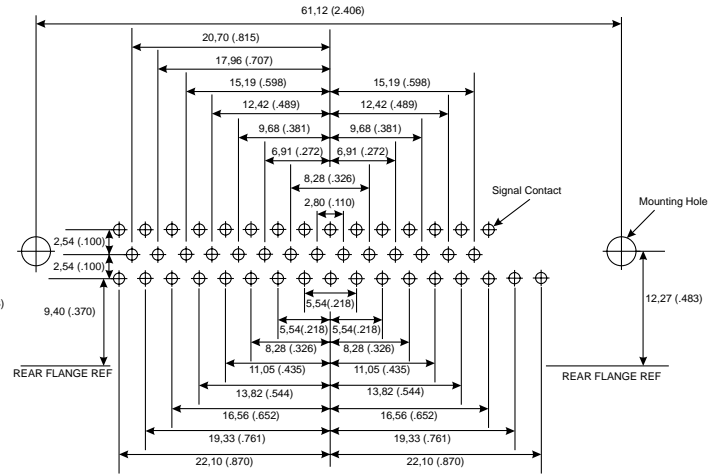

Shell Size D
 Contact Arrangement 43W2
 No. of Size 20 Cavities 41 #20
 No. of Size 8 Cavities 0 #8

Shell Size D
 Contact Arrangement 46W1
 No. of Size 20 Cavities 46 #20
 No. of Size 8 Cavities 0 #8

Reader's Resource

| Signal Contact Ø | Recommended PCB Hole Ø |
|-------------------|------------------------|
| 0,60 (.024) | 1,00 (.039) |
| Mounting Type | Recommended PCB Hole Ø |
| Without Boardlock | 3,05 (.120) |
| With Boardlock | 3,10 (.122) |

PCB Hole Pattern — European

90° PC Tails — Receptacle



Shell Size
Contact Arrangement
No. of Size 20 Cavities
No. of Size 8 Cavities

E
5W1
4 #20
0 #8

A
7W2
5 #20
0 #8

A
11W1
10 #20
0 #8



Shell Size
Contact Arrangement
No. of Size 20 Cavities
No. of Size 8 Cavities

B
9W4
5 #20
0 #8

B
13W3
10 #20
0 #8



Shell Size
Contact Arrangement
No. of Size 20 Cavities
No. of Size 8 Cavities

B
17W2
15 #20
0 #8

B
21W1
20 #20
0 #8

| Signal Contact Ø | Recommended PCB Hole Ø |
|-------------------|------------------------|
| 0,60 (.024) | 1,00 (.039) |
| Mounting Type | Recommended PCB Hole Ø |
| Without Boardlock | 3,05 (.120) |
| With Boardlock | 3,10 (.122) |

PCB Hole Pattern — European

90° PC Tails — Receptacle



Shell Size
Contact Arrangement
No. of Size 20 Cavities
No. of Size 8 Cavities

C
13W6
7 #20
0 #8



Shell Size
Contact Arrangement
No. of Size 20 Cavities
No. of Size 8 Cavities

C
17W5
12 #20
0 #8



C
21WA4
17 #20
0 #8



Shell Size
Contact Arrangement
No. of Size 20 Cavities
No. of Size 8 Cavities

C
25W3
22 #20
0 #8



C
27W2
25 #20
0 #8

| Signal Contact Ø | Recommended PCB Hole Ø |
|-------------------|------------------------|
| 0,60 (.024) | 1,00 (.039) |
| Mounting Type | Recommended PCB Hole Ø |
| Without Boardlock | 3,05 (.120) |
| With Boardlock | 3,10 (.122) |

PCB Hole Pattern — European

90° PC Tails — Receptacle



Shell Size
Contact Arrangement
No. of Size 20 Cavities
No. of Size 8 Cavities

D
24W7
17 #20
0 #8



D
36W4
32 #20
0 #8



Shell Size
Contact Arrangement
No. of Size 20 Cavities
No. of Size 8 Cavities

D
43W2
41 #20
0 #8



D
47W1
46 #20
0 #8

| | |
|-------------------|------------------------|
| Signal Contact Ø | Recommended PCB Hole Ø |
| 0,60 (.024) | 1,00 (.039) |
| Mounting Type | Recommended PCB Hole Ø |
| Without Boardlock | 3,05 (.120) |
| With Boardlock | 3,10 (.122) |

PCB Hole Pattern — Standard/European

Straight PC Tails — Plug



Shell Size
Contact Arrangement
No. of Size 20 Cavities
No. of Size 8 Cavities

E
5W1
4 #20
0 #8

A
7W2
5 #20
0 #8

A
11W1
10 #20
0 #8



Shell Size
Contact Arrangement
No. of Size 20 Cavities
No. of Size 8 Cavities

B
9W4
5 #20
0 #8

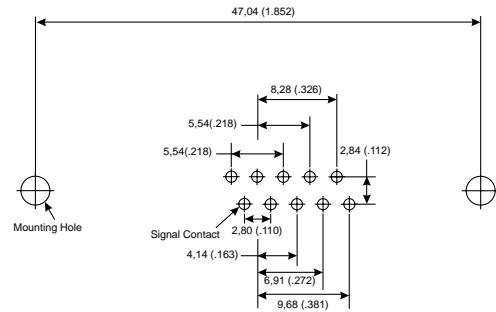

B
13W3
10 #20
0 #8



Shell Size
Contact Arrangement
No. of Size 20 Cavities
No. of Size 8 Cavities

B
17W2
15 #20
0 #8



B
21W1
20 #20
0 #8

Reader's Resource

| Signal Contact Ø | Recommended PCB Hole Ø |
|-------------------|------------------------|
| 0,60 (.024) | 1,00 (.039) |
| Mounting Type | Recommended PCB Hole Ø |
| Without Boardlock | 3,05 (.120) |
| With Boardlock | 3,10 (.122) |

PCB Hole Pattern — Standard/European

Straight PC Tails — Plug



Shell Size
Contact Arrangement
No. of Size 20 Cavities
No. of Size 8 Cavities

C
13W6
7 #20
0 #8



Shell Size
Contact Arrangement
No. of Size 20 Cavities
No. of Size 8 Cavities

C
17W5
12 #20
0 #8



Shell Size
Contact Arrangement
No. of Size 20 Cavities
No. of Size 8 Cavities

C
21WA4
17 #20
0 #8



Shell Size
Contact Arrangement
No. of Size 20 Cavities
No. of Size 8 Cavities

C
25W3
22 #20
0 #8



Shell Size
Contact Arrangement
No. of Size 20 Cavities
No. of Size 8 Cavities

C
27W2
25 #20
0 #8

| Signal Contact Ø | Recommended PCB Hole Ø |
|-------------------|------------------------|
| 0,60 (.024) | 1,00 (.039) |
| Mounting Type | Recommended PCB Hole Ø |
| Without Boardlock | 3,05 (.120) |
| With Boardlock | 3,10 (.122) |

PCB Hole Pattern — Standard/European

Straight PC Tails — Plug



Shell Size **D 24W7**
 Contact Arrangement
 No. of Size 20 Cavities **17 #20**
 No. of Size 8 Cavities **0 #8**



Shell Size **D 36W4**
 Contact Arrangement
 No. of Size 20 Cavities **32 #20**
 No. of Size 8 Cavities **0 #8**



Shell Size **D 43W2**
 Contact Arrangement
 No. of Size 20 Cavities **41 #20**
 No. of Size 8 Cavities **0 #8**



Shell Size **D 47W1**
 Contact Arrangement
 No. of Size 20 Cavities **46 #20**
 No. of Size 8 Cavities **0 #8**

Reader's Resource

| Signal Contact Ø | Recommended PCB Hole Ø |
|-------------------|------------------------|
| 0,60 (.024) | 1,00 (.039) |
| Mounting Type | Recommended PCB Hole Ø |
| Without Boardlock | 3,05 (.120) |
| With Boardlock | 3,10 (.122) |

PCB Hole Pattern — Standard/European

Straight PC Tails — Receptacle



Shell Size
Contact Arrangement
No. of Size 20 Cavities
No. of Size 8 Cavities

E
5W1
4 #20
0 #8



A
7W2
5 #20
0 #8



A
11W1
10 #20
0 #8



Shell Size
Contact Arrangement
No. of Size 20 Cavities
No. of Size 8 Cavities

B
9W4
5 #20
0 #8



B
13W3
10 #20
0 #8



Shell Size
Contact Arrangement
No. of Size 20 Cavities
No. of Size 8 Cavities

B
17W2
15 #20
0 #8



B
21W1
20 #20
0 #8

| Signal Contact Ø | Recommended PCB Hole Ø |
|-------------------|------------------------|
| 0,60 (.024) | 1,00 (.039) |
| Mounting Type | Recommended PCB Hole Ø |
| Without Boardlock | 3,05 (.120) |
| With Boardlock | 3,10 (.122) |

PCB Hole Pattern — Standard/European

Straight PC Tails — Receptacle



Shell Size
Contact Arrangement
No. of Size 20 Cavities
No. of Size 8 Cavities

C
13W6
7 #20
0 #8



Shell Size
Contact Arrangement
No. of Size 20 Cavities
No. of Size 8 Cavities

C
17W5
12 #20
0 #8



Shell Size
Contact Arrangement
No. of Size 20 Cavities
No. of Size 8 Cavities

C
21WA4
17 #20
0 #8



Shell Size
Contact Arrangement
No. of Size 20 Cavities
No. of Size 8 Cavities

C
25W3
22 #20
0 #8



Shell Size
Contact Arrangement
No. of Size 20 Cavities
No. of Size 8 Cavities

C
27W2
25 #20
0 #8

| Signal Contact Ø | Recommended PCB Hole Ø |
|-------------------|------------------------|
| 0,60 (.024) | 1,00 (.039) |
| Mounting Type | Recommended PCB Hole Ø |
| Without Boardlock | 3,05 (.120) |
| With Boardlock | 3,10 (.122) |

PCB Hole Pattern — Standard/European

Straight PC Tails — Receptacle



Shell Size D
 Contact Arrangement 24W7
 No. of Size 20 Cavities 17 #20
 No. of Size 8 Cavities 0 #8



Shell Size D
 Contact Arrangement 36W4
 No. of Size 20 Cavities 32 #20
 No. of Size 8 Cavities 0 #8



Shell Size D
 Contact Arrangement 43W2
 No. of Size 20 Cavities 41 #20
 No. of Size 8 Cavities 0 #8



Shell Size D
 Contact Arrangement 47W1
 No. of Size 20 Cavities 46 #20
 No. of Size 8 Cavities 0 #8

| Signal Contact Ø | Recommended PCB Hole Ø |
|-------------------|------------------------|
| 0,60 (.024) | 1,00 (.039) |
| Mounting Type | Recommended PCB Hole Ø |
| Without Boardlock | 3,05 (.120) |
| With Boardlock | 3,10 (.122) |

PCB Hole Pattern — Standard

90° — Plug & Receptacle



9 Contacts



37 Contacts



15 Contacts



25 Contacts



50 Contacts

| Signal Contact Ø | Recommended PCB Hole Ø |
|-------------------|------------------------|
| 0,76 (.030) | 1,14 (.045) |
| 1,00 (.040) | 1,40 (.055) |
| Mounting Type | Recommended PCB Hole Ø |
| Without Boardlock | 3,05 (.120) |
| With Boardlock | 3,10 (.122) |

Reader's Resource



9 Contacts



37 Contacts



15 Contacts



25 Contacts



50 Contacts

| Signal Contact Ø | Recommended PCB Hole Ø |
|-------------------|------------------------|
| 0,60 (.024) | 1,00 (.039) |
| Mounting Type | Recommended PCB Hole Ø |
| Without Boardlock | 3,05 (.120) |
| With Boardlock | 3,10 (.122) |

PCB Hole Pattern — Standard/European Straight — Plug & Receptacle



9 Contacts



15 Contacts



25 Contacts



37 Contacts



50 Contacts

| Signal Contact Ø | Recommended PCB Hole Ø |
|-------------------|------------------------|
| 0,60 (.024) | 1,00 (.039) |
| 0,76 (.030) | 1,14 (.045) |
| 1,00 (.040) | 1,40 (.055) |
| Mounting Type | Recommended PCB Hole Ø |
| Without Boardlock | 3,05 (.120) |
| With Boardlock | 3,10 (.122) |

ABT-607 Pneumatic Crimper

ABT-607



Products: D*A, MDSM, 75 Ohm Crimp Coax

The ABT-607 is a pneumatic powered and controlled machine. It is designed for customers with moderate volume. This machine is designed to semi-automatically crimp stamped and formed contacts onto pre-stripped stranded or single conductor electrical wire. This machine will accommodate size 34 thru 12 AWG wire and is actuated by the use of a foot pedal.

Machine Crimp Rate: 800 per hour

Power Requirements: Pneumatic = 100 psi, 2 cu. ft. per min.

ABT-620 UCCS Semi-Automatic Crimper/Stripper

ABT-620 UCCS



Products: D*A, MDSM

The ABT-620 Universal Cannon Crimper/Stripper is a pneumatic powered, microprocessor controlled machine. It is designed to semi-automatically strip insulation from stranded or single conductor electrical wire and attach a stamped and formed contact by crimping. The machine will accommodate 34 thru 12 AWG wire. Primary application of the machine is the termination of jacketed cable where the individual leads cannot be stripped on fully automated equipment. The ABT-620 UCCS operates automatically upon insertion of a wire or it can be switched over to foot pedal operation as desired.

Machine Strip/Crimp Rate: 1200+ per hour

Power Requirements: Electrical = 115 VAC, 60 Hz, 20 A
Pneumatic = 80 psi, 3 cu. ft. per min.

CBT-646 Vibra-Bowl Crimper

CBT-646



Products: D*MA

The CBT-646, Vibra-Bowl Crimper is a pneumatically powered, electronically controlled machine. It is designed to semi-automatically crimp closed barrel, machined contacts, as used in the aerospace and commercial industries. The machine will accommodate wire sizes 30 thru 12 AWG. The CBT-646 is actuated automatically upon insertion of a pre-stripped stranded or single conductor wire.

Machine Crimp Rate: 1300+ per hour

Power Requirements: Electrical = 115 VAC, 60 Hz, 5 A
Pneumatic = 85 psi, 2 cu. ft. per min.

Glossary of Terms

In every job speciality there are certain words and phrases used by the "insiders" which after a time become almost a language unique to that speciality. D Subminiature technology is a typical example of that condition.

The following pages provide some explanations, in an attempt to clarify some of the terms that are commonly used by engineers and sales staff at ITT Cannon.

The list is not comprehensive, but highlights many of the expressions commonly used. Should you have any comments or additions please contact us. Feedback will be appreciated.

Accelerated Aging — A connector test in which temperature, voltage, current, or other parameters are increased beyond the normal operating values to observe deterioration in a relatively short period of time.

Accessories — Auxiliary devices such as cable clamps, endbells, gaskets, or any number of mechanical hardware devices that can be added to a connector.

Alloy — A composition of two or more elements, of which at least one is a metal. In connector applications it is usually a combination of metals which is used to create an alloy superior in performance to any of its individual components.

Alternating Current — A flow of electricity which reaches a maximum in one direction, decreases to zero, then reverses itself and reaches maximum in the opposite direction. This cycle is repeated continuously. The number of such cycles per second is the frequency. The average value of the voltage during any cycle is zero. Abbreviated ac.

Ambient Temperature — The temperature of the environment surrounding the connector. Usually the air. Normally used as the reference when specifying the OPERATING TEMPERATURE range of the connector.

Ampere — A unit of electrical current or rate of flow of electrons. One volt across one ohm of resistance causes a current of 1 ampere. Abbreviated Amp or A.

Anodize — A protective, insulating oxide layer formed on a metal by electrolytic action. Occasionally used as the outer most layer in connector plating, anodize is a very tough, non-conductive plating.

Attenuation — Power loss in an electrical system, expressed in decibels.

AWG — American Wire Gauge. A standard for wire diameters based on the approximate circular mil area of the wire. As numbers get larger, wire diameters decrease in size (a size 16 AWG wire has a larger diameter than a size 22 AWG).

Backshell — (Also known as Endbell) The outer rear end of the connector which is attached by means of internal threads or screws. It adapts the connector to its wire connections in a variety of ways. Typical backshells might have cable clamps to secure a wire bundle, ridges for heat shrink tubing, pipe threads, or shielded termination mechanisms. Backshells may be straight, 90°, or 45°.

Bandwidth — The range of frequencies within which performance falls within specific limits. Usually the bandwidth is given as an operating range and the operating specifications apply only to that bandwidth, unless otherwise stated.

Bar — A centimeter-gram-second unit of pressure (force exerted on a unit of area) equal to 1,000,000 dynes per square centimeter. Formerly known as microbar. Its symbol is b.

Base Metal — The metal which the connector or connector component is made and over which various platings will be deposited.

Beryllium Copper — An alloy of copper used to make contacts. It is relatively expensive, but has superior spring qualities, is resistant to fatigue, and can operate at higher temperatures than other materials such as phosphor bronze. It is used when numerous insertion and extraction cycles are required.

Body — The main portion of the connector made of the shell, insulator, and contacts.

Boot — A rear accessory, usually made of a resilient material, which is used around a multiconductor cable to add additional insulation, strength, abrasion resistance, or sealing.

Brass — Metal alloy of copper and zinc used for contacts. It is low cost, an excellent conductor, and resists fatigue.

Breakdown — An electrical discharge through a connector insulator or insulation on a wire. A catastrophic failure mode.

Breakdown Voltage — The voltage at which an insulator ruptures.

Breakout — The point at which wires are separated from a multi-conductor cable or wire bundle for routing to other points.

C — Abbreviation for Centigrade, or more properly Celsius, since the term Centigrade was officially abandoned by international agreement in 1948. See CELSIUS.

Cable Assembly — A cable (or bundle of cables) with plugs and/or receptacles on each end.

Cable Clamp — A rear connector clamping accessory which tightens over a cable or wire bundle to provide strain relief to the cable. The cable clamp may be part of a more elaborate endbell or it may be used alone. Some cable clamps also provide cable jacket sealing using a resilient gland; for example the MS3057-C, others provide only strain relief.

Cadmium — A metallic element chemically related to zinc and mercury, widely used for plating. It has an extraordinary ability to resist outdoor corrosion. It is especially resistant to alkali. Cadmium is electrically conductive and it is easy to solder. Its symbol is Cd.

CECC — Abbreviation for Electronic Components Committee of CENELEC, the European committee for Electrotechnical Standardization. CECC uses the IEC test methods, and thus is based upon worldwide standards.

Celsius — A temperature scale in which the freezing point of water is 0° and the boiling point is 100° at normal atmospheric pressure. Formerly known as Centigrade, but officially changed to Celsius by international agreement in 1948.

CEN — Abbreviation for European Committee for Standardization. A European standards group corresponding to the ISO at the European level.

CENELEC — Abbreviation for European Committee for Electrical Standardization. A European standards group corresponding to the IEC at the European level.

Chamfer — A bevel cut on the inside edge of an insulator contact cavity or a mounting hole. In a contact cavity the chamfer is intended to guide the mating pin into the cavity. In a mounting hole it is a countersink to accept a cone shaped bolt.

Characteristic Impedance — The characteristic impedance of a transmission line is the impedance of the line when it is terminated in a perfect load (a load that absorbs all the energy and reflects none, such that VSWR = 1.00).

Clearance Hole — See Through Hole.

Closed Entry — An insulator design which limits the diameter of the mating contacts.

Glossary of Terms

Closed Socket Contact — A socket contact in which the mating cavity limits the entry of a contact or probe having a diameter larger than the mating pin.

Coax — Abbreviation for coaxial.

Coaxial Cable — A cable that comprises a single copper wire surrounded by insulating material, wire shielding or mesh, and a plastic protective sheath.

Component — An essential functional part of the connector.

Contact — The conductive element in a connector which makes the actual connection between the wire and the mating connector for the purpose of transferring electrical energy. Ideally the contact should add nothing to the circuit. In the real world, however, contacts typically have a small CONTACT RESISTANCE and associated potential drop.

Contact Alignment — The overall play that a contact has in the insulator cavity to allow the mating contacts to self align. Also called contact float.

Contact Arrangement — See LAYOUT.

Contact Cavity — A defined hole in the connector insulator into which the contacts fit. The cavities are generally marked with a unique designation or number for ease of identification.

Contact Resistance — The maximum amount of resistance which a contact introduces into the connection when carrying a specified current (usually stated in milliohms). When not stated, values are typically given for "Initial" or "new" contacts. Most specifications also limit the maximum resistance during or after each of a series of extreme tests, such as "Contact Resistance After Corrosion Test". These figures are typically slightly higher than "Initial".

Contact Retention — The maximum allowable axial load which can be applied to a contact from either direction without it being dislodged from the insulator. Usually stated in Newtons or pounds of force.

Contact Separation Force — The force required to separate a pair of mated contacts. Usually stated in Newtons or pounds of force.

Contact Size — This usually relates to the maximum size wire this contact can nominally accommodate. It is based on that AWG size most closely corresponds to the circular mil area of the engaging end of a pin contact for that size. For example, a size 16 contact can accommodate a size 16 AWG wire maximum and the pin corresponds to the CMA of a size 16 AWG. Note, however, that oversized crimp pots are available for some crimp contacts which will allow, for example, a size 16 contact to accommodate a size 14 AWG wire.

Contact Spacing — The distance between the centers of adjacent contacts.

Creepage — The conduction of electricity across the surface of an insulator.

Creepage Distance — The shortest distance between contacts of opposite polarities, or between a live contact and ground, measured over the surface of the insulator.

Creepage Path — A path across the surface of the insulator between two conductors. Lengthening the path reduces the possibility of arc damage.

Crimp — A method of attaching a contact to a wire through the application of pressure.

Crimp Contact — A contact which is terminated to a wire by means of crimping with an appropriate die and tool. After termination, an insertion tool is normally used to insert the crimped contact into the connector. Removable crimp contacts can be FRONT RELEASE or REAR RELEASE. An extraction tool is usually required to remove the contact.

Crosstalk — Undesired electrical currents in conductors caused by electromagnetic or electrostatic coupling from other conductors or from external sources. Also, leakage of optical power from one optical conductor to another.

CSA — Abbreviation for Canadian Standards Association.

Current — The movement of electrons through a conductor. Current is measured in amperes. Its symbol is I.

Current Rating — The maximum current that a particular wire, contact, or connector can accommodate. NOTE: When several wires are used in a single connector or elevated temperature or altitude is involved, derating curves must be applied to these ratings. A typical derating system is MIL-W-5088 which allows the user to calculate the derating effects of current, ambient temperature, number of wires in the bundle, and altitude.

Decibel — A standard unit of measure for transmission gain or loss. It expresses the ratio of power input to power output. Abbreviated dB. The term dBm is used when 1 milliwatt is the reference level.

Derating — To reduce the voltage, current, or power rating of a connector to improve its reliability or to permit operation at high ambient temperatures or altitudes.

Derating Curve — A graph of the change in power handling capability of a connector as a function of ambient temperature or altitude. Typically the graphed function is curved, hence the name.

Diallyl Phthalate — A thermosetting plastic used for insulators and some types of connector housings. It has outstanding resistance to chemicals, excellent dimensional stability, and superior electrical insulating properties.

Dielectric — An insulator used to isolate two conductors having a low loss factor (RF cables). The perfect insulator is a vacuum.

Dielectric Constant — That property (K) of an insulating material which is the ratio of the parallel capacitance (C) of a given configuration of electrodes with the material as the dielectric, to the capacitance of the same electrode configuration with a vacuum as the dielectric.

Digital — A signal comprising discrete elements.

DIN — Abbreviation for Deutsche Industrie Norm, a German standards organization.

Direct Current — An essentially constant value of current that flows in only one direction. Abbreviated dc.

Dust Cap — A cover used in place of a mating connector to seal it against dirt and moisture. Usually secured to the connector by a captive chain, wire, or rope.

Electroplating — To deposit a metal on the surface of a conductor using electrolysis.

EMI/RFI — Electro-Magnetic Interference and Radio Frequency Interference. This is unwanted stray electronic radiation which may enter, and/or be emitted by an electronic system. The most common method of shielding interconnections against this radiation is to use wires with a metallic braided shield and a connector system which will extend the shield through the interconnection. This type of design will keep radiation from entering, or being emitted by the system. Backshells for shielded cable and connectors with threads or grounding fingers are typically used for this purpose. Call for the specific EMI/RFI accommodations of the connectors in this catalog.

Glossary of Terms

EN — Abbreviation for Euro Norm. A European market-wide product standard.

Endbell — See BACKSHELL.

Extraction Tool — A device used to remove a (removable) contact from a connector insulator. The extraction tool may be inserted into the mating face of the insulator (FRONT RELEASE) or the wire side (REAR RELEASE). In either case, the contact comes out the rear, or wire side, of the connector.

Fahrenheit — A temperature scale in which the freezing point of water is defined as 32° and the boiling point is 212° at normal atmospheric pressure. See the conversion tables for converting Fahrenheit to Celsius. Abbreviated F.

Female Contact — See SOCKET CONTACT.

Ferrule — A bell shaped ring which is placed over a WIRE SEALING GROMMET to provide uniform axial compression of the grommet and to minimize the transmission of torque to the grommet when the backshell is screwed on to the rear of the connector. Ferrules are a part of the sealing mechanism at the rear of a connector. Ferrules are normally a separate component part of the connector although some backshells have integrated ferrules. Ferrules are usually made from a thermoplastic material, but occasionally ferrules are made of metal.

Finish — The metallic coatings used on contacts and metal connectors. These are thin layers of metal designed to improve conductivity, solderability, or to resist corrosion. Typical contact finishes are gold or silver. Typical shell finishes are olive drab over cadmium, electroless nickel, or black anodize.

Flange — A square mounting flange with four mounting holes for bolting the connector to a panel. The mounting holes may be through holes or threaded.

Flanged Receptacle — (Also known as a Box Mount or Wall Mount) The shell of this connector has a square flange with mounting holes at each corner. Mounting holes are usually through holes, but may be threaded. Flanged receptacles can usually be front or rear panel mounted depending upon panel thickness. Some connectors have two different versions, one for front mounting, and one for rear panel mounting.

Flash Plating — As commonly used in connector terminology, flash refers to extremely thin platings of metal, for example: gold flash is a very thin plating of gold. So thin, that the thickness is generally not specified.

Front Mounting — A receptacle that can only be mounted to the front of a panel with its mounting FLANGE outside the equipment.

Front Release — For crimp type removable contacts, front release means that the appropriate extraction tool is *inserted from the front*, or mating face, of the connector. The contact is then pushed out the *rear* (wire side) of the connector.

Gas Tight — The mating of two contact surfaces which are so tight that corrosive gasses can not enter the joint.

Gold — A precious metal that is more conductive than silver or copper. Because it does not corrode and is highly conductive, it is used as plating for contacts. Its chemical symbol is Au.

Grommet Cavity — A defined hole in the WIRE SEALING GROMMET through which the wires are passed. The cavities are generally marked with a unique designation or number for ease of use.

Guide Pin — A special pin which is inserted into a socket contact before the contact can be inserted into the connector insulator. Guide pins provide a rounded surface at the front of the socket and greatly aid in pushing the contact into the insulator thus avoiding damage to both the insulator and the contact. Typically, small size socket contacts require the use of guide pins while larger sizes can be inserted without them.

Harness — A group of wires or cables bundled together with attached connectors and/or components in a preshaped assembly.

Hz — Symbol for Hertz, an international unit of frequency equal to one cycle per second. That is, 20,000 Hz is 20,000 cycles per second.

I/O — Input/Output

IEC — Abbreviation for the International Electrotechnical Commission. An international organization that develops standards exclusively for electrical engineering. CENELEC is the equivalent organization at the European level.

Impedance Match — When a transmission line is terminated so that $VSWR = 1.00$. Another definition is when a source is terminated in an impedance that allows optimum energy transfer.

Indentor — The part of a crimping die which indents the contact barrel to form the actual crimp. Indentors normally make six or eight multiple indentions for each crimp.

Initial — A test result taken prior to any other environmental testing. For example, contact resistance is frequently specified "Initial", that is, with "new" contacts. Most specifications also limit the maximum resistance during or after each of a series of extreme tests, such as "Contact Resistance After Corrosion Test". These figures are typically slightly higher than "Initial".

Insert — See INSULATOR.

Insert Arrangement — See LAYOUT.

Insert Retention Force — The maximum allowable force which should be applied to the face of the insulator without dislodging it from the shell or causing any change in connector performance specifications. Usually stated in Newtons or pounds of force.

Insertion Force — The effort, usually stated in ounces or Newtons, required to engage two contacts or connector halves.

Insertion Loss — The attenuation that results when a transducer is inserted in a transmission line. It is the ratio of the power input to the transducer to the power out of the transducer expressed in decibels.

Insertion Tool — A small, hand-held tool used to insert contacts into a connector.

Insulation — A material that has high electrical resistance and is suitable for covering or encasing electrical components to prevent a short circuit.

Insulation Displacement Connector (IDC) — A connector contact with sharp tines which pierce and displace the wire insulation and make direct electrical connection with the conductor. Normally used with multipin connectors which must be terminated to flat cable. This is a fast, low cost method to terminate many conductors simultaneously.

Insulation Resistance — The minimum resistance (usually stated in Megohms) between adjacent contacts and between the contacts and the shell at a specific voltage. When not stated, values are typically given for new insulators. Most specifications also specify minimum resistance figures during or after each of a series of extreme tests, such as "Insulation Resistance During Dry Heat".

Insulation Support — An extended portion at the rear of a crimp contact that is crimped around the wire insulation to provide extra strain relief. This crimp is in addition to the crimp over the conductor which provides the actual electrical termination.

Glossary of Terms

Insulator — The insulating element into which the contacts are mounted in a connector. This can be a resilient material, thermoplastic, or a thermoset compound, among other materials.

Insulator Rotation — A method of differentiating a circular connector if more than one connector with the same sex and layout is to be used in a system. The insulator is permanently positioned in the shell so that only a connector with the same degree of rotation can be mated with it. Possible rotations are specific to each layout with some layouts having many possible rotations and others having none. A chart of valid rotations is listed by layout for connectors capable of being rotated. Most connector series use the military convention of assigning letter designations for specific degrees of rotation (for example: W, X, Y, Z). See KEYING.

Interchangeable — The characteristic of connectors in which a connector half of one manufacturer or series will directly replace that of another manufacturer and provide the same electrical and mechanical function.

Intermateable — The characteristic of connectors in which a connector half of one manufacturer or series will mate directly with the connector half of another manufacturer.

Intermittent — Occurring at intervals. A connection which passes electrical current only in random or undesirable intervals.

Intermountable — The characteristic of connectors in which one manufacturer's connector or series will mount in exactly the same panel space and mounting holes as another manufacturer's product.

ISO — Abbreviation for the International Standards Organization. A group that operates at the international level and sets most standards for industry, with the exception of electrical engineering and telecommunications which are set by the IEC and ITU respectively. CEN is the equivalent organization at the European level.

Jacket — The outermost layer of insulation in a cable composed of several wires.

Jackscrew — A screw attached to one half of a connector pair used to mechanically align, draw them together, and lock them in place.

Key — A mechanism used to polarize connectors by the user. See KEYING.

Keying — A method of differentiating a connector if more than one connector with the same sex and layout is to be used in a system. The key is usually a pin or other projection which can be located in a contact cavity or slot. The key will prevent a connector without a matching orifice from mating. Keying and POLARIZATION serve the same function, but keying can be done by the user, while polarization is manufactured into the connector and normally can not be altered by the user.

Layout — The number, size, and geometric arrangement of the contacts in a connector. When a connector is said to have a certain "layout" it refers to a specific contact configuration. For example, Combo D® has 2 pages of drawings showing the arrangement of the contacts in the insulator. Each of these contact cavity arrangements can be referred to as a layout.

Locator — A part of a crimping tool TURRET. Rotation of the locator sets the tool for a particular size or sex contact. See TURRET.

Male Contact — See PIN CONTACT.

Mating Life — The minimum number of times a connector can be mated and unmated and still meet all of its design specifications. The maximum life may be much higher than this figure.

Mil — One thousandth of an inch (.001). Used in the United States as a unit of length in wire diameters and linear dimensions.

Mil-Spec — Abbreviation for Military Specification.

Milliampere — One one-thousandth (.001) of an ampere. Abbreviated mA.

Millimeter — Metric unit of linear measure. 1 millimeter = .03937 inches. Abbreviated mm.

Milliohm — One one-thousandth (.001) of an ohm. Abbreviated mΩ.

mm² — Millimeters squared. A standard for wire diameters used in Europe instead of AWG. As numbers get larger, wire diameters increase in size. The relationship between mm² and AWG is reverse logarithmic. 1 mm² = 1973 circular mils. A conversion graph is needed to make accurate comparisons between AWG and mm². Call for assistance.

Mounting Clip — Any of a variety of mounting accessories used to secure a connector or connector pair to a rigid surface.

Multi-Conductor Cable — Two or more individual wires surrounded by a jacketing material.

Nest — The portion of a crimping die that supports the contact barrel during crimping.

Newton — A unit of acceleration. One Newton is the force capable of accelerating 1 kilogram to one meter per second per second. 1 pound force = 4.448221 Newtons. Abbreviated N.

Ohm — The unit of electrical resistance. One ohm is the value of resistance through which a potential difference of one volt will maintain a current of one ampere. Its symbol is the Greek letter omega (Ω).

Operating Temperature — The range of AMBIENT TEMPERATURES over which the connector can operate and still meet all of its design specifications.

Operating Voltage — The range of voltages over which the connector can be operated. Safety precautions must be taken anytime a voltage in excess of 50V is to be used in a circuit. Check your local and national codes for guidelines.

Outgassing — The circumstance in which an insulator releases gasses trapped within it under a vacuum or conditions of decreased pressure, high heat, or both.

Panel — The outside surface of a piece of equipment on to which connectors are mounted. The panel is usually made of metal.

Panel Mount — A connector designed to be mounted on a panel by means of screws or jam nut.

PCB — Abbreviation for Printed Circuit Boards.

Performance Class 1 — Performance class per European specification DIN 41652, specifying contact performance to 500 mating cycles, followed by testing per DIN 41640, Part 21. The contact is subjected to severe environmental conditions, including industrial gasses, after the 500 mating cycles, and must meet basic contact resistance, engaging force, and separation force tests.

Performance Class 2 — Performance class per European specification DIN 41652, specifying contact performance to 200 mating cycles, followed by testing per DIN 41640, Part 21. The contact is subjected to severe environmental conditions, including industrial gasses, after the 200 mating cycles, and must meet basic contact resistance, engaging force, and separation force tests.

Glossary of Terms

Performance Class 3 — Performance class per European specification DIN 41652, specifying contact performance to 50 mating cycles, followed by testing per DIN 41640, Part 21. The contact is subjected to severe environmental conditions, including industrial gasses, after the 50 mating cycles, and must meet basic contact resistance, engaging force, and separation force tests.

Peripheral Seal — A resilient seal used to keep moisture from entering the connector at the point where the plug and receptacle shells meet. A common method is to use flat gaskets on receptacles and O-rings on plugs.

Phosphor Bronze — An alloy of copper, tin, and phosphorus used to make spring contacts. It is typically used in lower cost contacts where frequent insertions and withdrawals and high temperatures are not a factor.

Pin — A male contact. See PIN CONTACT.

Pin Contact — The contact which has a long shaft at the engagement end which enters the socket contact.

Plating — See FINISH.

Plug — The male portion of a connector pair usually employing a coupling nut to secure it to the receptacle half. A plug may have either pin or socket contacts.

Polarization — A mechanical mechanism that allows connector halves to intermate in only one specific orientation. This can be accomplished by asymmetrical shapes of the two halves as in a D Subminiature connector, insulator rotation, keys, keyways, ramps, or other means. Polarization prevents connectors of the same size and/or same layout from intermating when this is undesirable, such as when two otherwise identical connectors are used on the same panel. Polarization is typically done by the assembler and can not be changed by the user, while keying is typically done by the user with an auxiliary keying device.

Polarizing Pin — A mechanism used to polarize connectors, manufactured into the connector. See KEYING.

Potting — The permanent sealing of a cable to a connector using an insulating material such as potting compound to exclude moisture or provide strain relief. See POTTING CUP.

Potting Compound — A sealing material used in potting to fill a potting cup.

Potting Cup — A bell-shaped (plastic) backshell with an enlarged opening for the wires. After the connector is loaded with wired contacts, the potting cup is attached to the rear of the connector. The inside of the cup is then filled with a potting compound. When the compound hardens, it forms a solid, permanent, watertight mass around the wires.

Potting Ring — A portion of the POTTING CUP which secures the bell shaped cup to the rear of the connector, usually by means of internal threads.

Pre-Tin — To apply tin-lead solder to the contact solder cup and/or conductor prior to soldering the two together.

Rear Mounting — A receptacle that mounts through the panel from the rear, with its mounting flange inside the equipment. Typically, rear mount receptacles are slightly longer than front mount types to allow for the thickness of the panel. Flange mount receptacles usually come in front and rear mount versions. All Jam nut receptacles are rear mount.

Rear Release — For crimp type removable contacts, rear release means that the appropriate extraction tool is *inserted from the rear*, or wire side, of the connector. The contact is then pulled out the rear of the connector.

Receptacle — The connector half that mates with the plug. The receptacle has threads, pins or ramps which engage the coupling nut on the plug, locking the two halves together. A receptacle may have either pin or socket contacts.

REF — Abbreviation for Reference.

Removable Contact — A contact which can be inserted and removed from the insulator by the user. An insertion tool and extraction tool are normally required to insert and remove the contact.

Removal Tool — See EXTRACTION TOOL

Resistance — That property of a substance which impedes current and results in the dissipation of power in the form of heat. The unit of resistance is the ohm.

Return Loss — The ratio of the power reflected from a discontinuity in a transmission line to the power incident.

RFI — See EMI/RFI.

Root Mean Square — The square root, of the average of the squares, of the values of a periodic quantity (like alternating current), taken through one complete period. It is the effective quantity of a periodic quantity. Abbreviated rms.

Salt Spray Test — A test, or series of tests, in which mated and/or unmated connectors are subjected to salt water under specified conditions. Used to test the connector's resistance to corrosion and any associated degradation in electrical function.

Screw Machine Contact — A contact made from a solid bar or rod using screw machine operations. Some screw machine contacts include secondary elements which are welded, crimped, or formed around the basic screw machined part to complete the contact.

Selective Plating — The application of metal PLATING to selective areas of the contact, particularly those areas subject to wear. Precious metal platings may be applied selectively to those contact surfaces responsible for the electrical connection, reducing the contact cost without sacrificing electrical performance.

Shell — The outside case of a connector into which the insulator and contacts are situated.

Shell Size — A standard system developed for military circular connectors for indicating the diameter of the shell. The system is based upon $\frac{1}{16}$ " increments, that is, a size 16 shell is one inch in diameter.

Shield Effectiveness — The ability of a shield to screen out undesirable signals.

Shock — An abrupt impact applied to a stationary object. It is usually expressed in gravities (g).

Socket — A female contact. See SOCKET CONTACT.

Socket Contact — The contact which has an opening at the engagement end to accept the pin contact.

Solder Contact — A contact which is terminated to the wire with solder. Solder contacts are normally bonded into the insulator and can not be removed by the user. The alternative is crimp contacts to which a wire is attached by crimping. Crimp contacts can usually be inserted and removed by the user.

Solder Cup — The end of a SOLDER CONTACT is designed to accept a wire which will then be soldered to the contact.

Stamped and Formed Contact — Contacts made by stamping and forming a sheet of metal rather than by machining metal stock. Also see SCREW MACHINE CONTACTS.

Glossary of Terms

Star Clip — One of several designs used for screw machine socket contacts. A tiny plated star shaped clip is captivated inside a solid barrel into which the pin contact fits. The clip creates a multi-point area of mechanical and electrical continuity between the mated contacts.

Stripper — A tool to remove insulation from a wire.

Test Voltage — The range of voltages over which the connector has been tested per the perimeters in the applicable specification.

Thermoplastic — A plastic material that can be softened by heat and rehardened into a solid state by cooling. This process can be accomplished using a variety of techniques.

Thermoset — A plastic material which hardens when heat and pressure are applied. Unlike thermoplastic, it cannot be remelted or remolded.

Through Hole — (Also known as a clearance hole) A mounting hole without threads.

Turret — An interchangeable device which is attached to a CRIMP TOOL that allows the tool to crimp a range of contacts. Each turret is made to crimp a specific style contact or a range of contacts and/or wire gauges. See LOCATOR.

UL — Abbreviation for Underwriter's Laboratories, a corporation supported by a group of underwriters for the purpose of establishing safety standards covering certain types of equipment and components in the United States.

UL 94V-0 — A flammability performance rating set by Underwriter's Laboratories for plastics.

V — Symbol for volt.

Vac — Volts, alternating current.

Vdc — Volts, direct current.

Vibration — A continuously reversing change in the magnitude of a given force.

Volt — The unit of measurement of electromotive force. It is equivalent to the force required to produce a current of 1 ampere through a resistance of one ohm.

Voltage — The force which causes current to flow through an electrical conductor. Its symbol is E. The greatest effective difference in potential between and two conductors of a circuit.

Voltage Drop — The difference in voltage between two points in a circuit due to the loss of electrical pressure as a current flows through an impedance.

Voltage Rating — The maximum voltage which a connector can sustain without breaking down or varying from design specifications.

Voltage Standing Wave Ratio — If a signal is sent down a transmission line any discontinuity will send a reflection back in the opposite direction.

Wire Sealing Grommet — A resilient disc with holes in it to accommodate the individual wires entering the rear of the connector. Each cavity forms a tight seal against the wire insulation (as long as wires within the specified diameter are used). The grommet seals the back of the connector against moisture, dirt, and air. The grommet is normally held in place and compressed by a backshell and/or ferrule. It is usually a separate component, but may be part of the insulator itself. Also see GROMMET CAVITY.

Wire Size — A numerical designation for conductor diameter. This catalog uses American Wire Gauge (AWG) which is based on the approximate circular mil area of the wire. See AWG and mm².

Wrap Post Contact — A type of contact which is terminated by wrapping wire around a post in a manner that deforms the wire and creates a gas-tight connection between the wire and the post. This method is slow and labor intensive. If used at all, it is used in prototype work.

Obsolete Products

General Application Connectors ♦

| | | |
|--|--|---|
| <p>D*C <i>Burgun D</i> with snap-in, rear release machined or stamped crimp contacts. Refer to D*U products.</p> | <p>D*PF Straight and 90° PCB applications, UL 94V-0 rated. Refer to D* products.</p> | <p>D*11148 D*(SMT) SMT – Surface Mount D, no replacement, only through holes available. Refer to ZED* products.</p> |
| <p>D*P 90° connectors for I/O applications, UL 94V-0 rated. Refer to D*U products</p> | <p>AD* Part number change only. Refer to ZD* products.</p> | <p>D*P1 Machined pressfit replaced by stamped pressfit. Refer to D*NG products.</p> |
| | | <p>D*TC Part number change only. Refer to D* products.</p> |

Available Products Not Listed Within This Publication

General Application Connectors ♦

| |
|---|
| <p>D*U <i>Burgun D</i> with snap-in, rear release machined or stamped crimp contacts, UL 94V-0 rated.</p> |
| <p>D*Sf <i>Speedy D</i> for IDC ribbon cable, UL 94V-0 rated, accomodates Sizes 28-26 AWG cable on 1,27 (.050) conductor spacing.</p> |

| |
|--|
| <p>D*MA Military specification quality removable crimp style contacts for high performance applications.</p> |
| <p>ZD*A Low cost, stamped contacts, high density 90° PCB connectors.</p> |

Special Application Connectors ♦♦

| |
|---|
| <p>GD* <i>Grommet D</i> environmentally sealed, crimp, snap-in, rear release contacts.</p> |
| <p>D*D Environmentally sealed, cast aluminium shell. Product not intermatable with M24308 type D Subminiature connectors.</p> |

♦ Commercial Applications Only

♦♦ Military or Commercial Applications

Consult factory for details.

D Subminiature

Part Number Index

| Part Number | Page | Part Number | Page | Part Number | Page | Part Number | Page |
|-----------------|----------|----------------|----------|---------------------|----------|-------------------|------|
| 015-8755-000 | 207 | CA111972-12 | 98 | DA15P-1ATN-K87 | 26 | DAJK15S*-1AJN | 117 |
| 015-8755-001 | 207 | CA111972-22 | 98 | DA15P-1AUN-K87 | 26 | DAJK15S*-1APN | 119 |
| 030-2042-002 | 195 | CA112104 | 102 | DA15P-1AVN-K87 | 24 | DAJK15S*-1ATN | 119 |
| 030-2487-016 | 83 | CA112104-1 | 102 | DA15P-1AWN-K87 | 24 | DAJK15S*-1AUN | 119 |
| 030-2487-017 | 83 | CA112104-2 | 102 | DA15P-F179A-K87 | 12 | DAJK15S*-1AVN | 117 |
| 030-2488-016 | 83 | CA112104-3 | 102 | DA15PK87 | 32 | DAJK15S*-1AWN | 117 |
| 030-2488-017 | 83 | CA112104-4 | 102 | DA15S-OL2-A197 | 11 | DAJK15S*-1UON | 109 |
| 030-8848-020 | 187, 195 | CA112104-5 | 102 | DA15S-1A5N-A197 | 27 | DAJK15S*-1U7N | 113 |
| 030-8882-002 | 187, 195 | CCTP-750HM | 84 | DA15S-1A6N-A197 | 27 | DAJK15S*-1U7N-146 | 113 |
| 031-1007-052-05 | 195 | CCTP-DM | 84 | DA15S-1A7N-A197 | 23 | DAJK15S*-OL4 | 121 |
| 031-1147-002 | 195 | D110277 | 212 | DA15S-1A8N-A197 | 23 | DAJKE15P*-1A0N | 110 |
| 031-8787-020 | 187, 195 | D110278 | 212 | DA15S-1A9N-A197 | 23 | DAJKE15P*-1U0N | 108 |
| 031-8843-001 | 187, 195 | D110279 | 212 | DA15S-1ADN-A197 | 25 | DAJKE15P*-OL4 | 120 |
| 031-8902-000 | 195 | D110280 | 212 | DA15S-1AFN-A197 | 23 | DAJKE15P*-OL4-146 | 120 |
| 031-8902-001 | 187 | D110550 | 213 | DA15S-1AJN-A197 | 25 | DAJKE15S*-1A0N | 111 |
| 031-8944-000 | 187, 195 | D110551 | 213 | DA15S-1A0N-A197 | 21 | DAJKE15S*-1U0N | 109 |
| 070051-0000 | 89 | D115418-70 | 195 | DA15S-1ATN-A197 | 27 | DAJKE15S*-OL4 | 121 |
| 070064-0002 | 88 | D115433-1 | 40, 82 | DA15S-1AUN-A197 | 27 | DAJKE15S*-OL4-146 | 121 |
| 075-0354-003 | 218 | D115433-2 | 40, 82 | DA15S-1AVN-A197 | 25 | DAJKE15P*-1A0N | 110 |
| 110238-1012 | 84 | D115433-3 | 40, 82 | DA15S-1AWN-A197 | 25 | DAJKX15P*-OL4 | 120 |
| 110238-1013 | 84 | D121073-19 | 201 | DA15S-F179A-A197 | 13 | DAJKX15P*-OL4-146 | 120 |
| 110238-1014 | 84 | D121073-39 | 209 | DA15SA197 | 33 | DAJKX15S*-1A0N | 111 |
| 110238-1015 | 84 | D121073-40 | 209 | DA19678-1 | 204 | DAJKX15S*-OL4 | 121 |
| 248-2967-000 | 95 | D121073-41 | 209 | DA19678-157 | 195 | DAJKX15S*-OL4-146 | 121 |
| 249-2271-000 | 84 | D121073-42 | 209 | DA19678-167 | 193, 195 | DAJT15P | 122 |
| 249-2272-000 | 84 | D130322-1 | 84 | DA19678-174 | 195 | DAJT15S* | 123 |
| 250-8501-004 | 201 | D130322-2 | 84 | DA19977-1 | 204 | DAJT3W3P1 | 128 |
| 250-8501-009 | 201 | D130322-6 | 84 | DA19977-40 | 193, 195 | DAJT3W3P1-1A0N | 124 |
| 250-8501-010 | 201 | D130344 | 84 | DA20961 | 203 | DAJT3W3P1-OL4 | 126 |
| 250-8501-013 | 201 | D130344-1 | 84 | DA20961-16 | 192 | DAJT3W3P5 | 128 |
| 259-8760-000 | 207 | D130344-2 | 84 | DA22213 | 215 | DAJT3W3P5-1A0N | 124 |
| 274-5016-002 | 187 | D130356 | 85 | DA22214 | 214 | DAJT3W3P5-OL4 | 126 |
| 274-7003-000 | 187 | D130356-1 | 85 | DA24658 | 203 | DAJT3W3P6 | 128 |
| 274-7048-000 | 187 | D130356-3 | 85 | DA24658-15 | 192, 195 | DAJT3W3P6-1A0N | 124 |
| 304-0444-000 | 84 | D130357 | 85 | DA50905-1 | 218 | DAJT3W3P6-OL4 | 126 |
| 304-8810-000 | 40, 82 | D130357-1 | 85 | DA51210 | 206 | DAJT3W3P9 | 128 |
| 304-8811-000 | 40, 82 | D130357-4 | 85 | DA51211 | 206 | DAJT3W3P9-1A0N | 124 |
| 304-8812-000 | 40, 82 | D20418-101 | 194-195 | DA51220-1 | 210 | DAJT3W3P9-OL4 | 126 |
| 304-8813-000 | 40, 82 | D20418-2 | 209 | DA53750-1 | 218 | DAJT3W3S1 | 129 |
| 323-7010-000 | 187 | D20418-39 | 209 | DAA11W1PK87F0 | 80 | DAJT3W3S1-1A0N | 125 |
| 330-5291-081-02 | 195 | D20418-50 | 209 | DAA11W1SA197F0 | 81 | DAJT3W3S1-OL4 | 127 |
| 330-8753-101 | 41 | D20418-52 | 194-195 | DAA15PK87F0 | 36 | DAJT3W3S5 | 129 |
| 330-8753-102 | 41 | D20418-70 | 194 | DAA15SA197F0 | 37 | DAJT3W3S5-1A0N | 125 |
| 330-8753-103 | 41 | D20418-74 | 209 | DA3W3PK87F0 | 80 | DAJT3W3S5-OL4 | 127 |
| 330-8754-101 | 41 | D20418-80 | 209 | DA3W3SA197F0 | 81 | DAJT3W3S6 | 129 |
| 330-8754-102 | 41 | D20419 | 208 | DA7W2PK87F0 | 80 | DAJT3W3S6-1A0N | 125 |
| 330-8754-103 | 41 | D20419-104 | 208 | DA7W2SA197F0 | 81 | DAJT3W3S6-OL4 | 127 |
| 330-8782-001 | 187, 195 | D20419-18 | 208 | DABS-15 | 205 | DAJT3W3S9 | 129 |
| 330-8944-000 | 195 | D20419-21 | 208 | DABU111512 | 216 | DAJT3W3S9-1A0N | 125 |
| 330-8944-001 | 187 | D20419-48 | 194-195 | DAE15P-OL2-K87-146 | 10 | DAJT3W3S9-OL4 | 127 |
| 980-0005-722 | 187 | D20419-73 | 194-195 | DAE15PK87 | 32 | DAJT3WK3P1 | 128 |
| 980-0008-135 | 83 | D20419-74 | 194-195 | DAE15S-OL2-A197-146 | 11 | DAJT3WK3P1-1A0N | 124 |
| 980-0008-136 | 83 | D20419-84 | 194-195 | DAE15SA197 | 33 | DAJT3WK3P1-OL4 | 126 |
| 980-2000-345 | 202 | D20420 | 208 | DAJK15P*-1A0N | 110 | DAJT3WK3P5 | 128 |
| 980-2000-346 | 202 | D20420-13 | 208 | DAJK15P*-1A5N | 118 | DAJT3WK3P5-1A0N | 124 |
| 980-2000-347 | 202 | D20420-15 | 208 | DAJK15P*-1A6N | 118 | DAJT3WK3P5-OL4 | 126 |
| 980-2000-348 | 202 | D20420-49 | 194-195 | DAJK15P*-1A7N | 114 | DAJT3WK3P6 | 128 |
| 980-2000-349 | 202 | D20420-63 | 194-195 | DAJK15P*-1A8N | 114 | DAJT3WK3P6-1A0N | 124 |
| 980-2000-426 | 187 | D20420-67 | 194-195 | DAJK15P*-1A9N | 114 | DAJT3WK3P6-OL4 | 126 |
| 980-2000-858 | 209 | D20420-86 | 208 | DAJK15P*-1ADN | 116 | DAJT3WK3P9 | 128 |
| 980-2000-859 | 209 | D20420-88 | 194-195 | DAJK15P*-1AFN | 114 | DAJT3WK3P9-1A0N | 124 |
| 980-2000-860 | 211 | DA-59-20 | 195, 218 | DAJK15P*-1AGN | 116 | DAJT3WK3P9-OL4 | 126 |
| 980-2000-923 | 83 | DA-60-20 | 195, 218 | DAJK15P*-1AHN | 114 | DAJT3WK3S1 | 129 |
| 980-2000-924 | 83 | DA111806-1 | 216 | DAJK15P*-1AJN | 116 | DAJT3WK3S1-1A0N | 125 |
| 980-2000-925 | 83 | DA111806-5 | 216 | DAJK15P*-1APN | 118 | DAJT3WK3S1-OL4 | 127 |
| 980-2000-926 | 83 | DA111810 | 216 | DAJK15P*-1ATN | 118 | DAJT3WK3S5 | 129 |
| 980-2000-943 | 83 | DA111810-3 | 216 | DAJK15P*-1AUN | 118 | DAJT3WK3S5-1A0N | 125 |
| 980-2000-944 | 83 | DA115339-1 | 207 | DAJK15P*-1AVN | 116 | DAJT3WK3S5-OL4 | 127 |
| 980-2000-945 | 83 | DA115339-21 | 205 | DAJK15P*-1AWN | 116 | DAJT3WK3S6 | 129 |
| 980-2000-946 | 83 | DA115386-104A | 195 | DAJK15P*-1U0N | 108 | DAJT3WK3S6-1A0N | 125 |
| 995-0001-244 | 187 | DA115386-2B | 207 | DAJK15P*-1U7N | 112 | DAJT3WK3S6-OL4 | 127 |
| 995-0001-325 | 187 | DA121073-150 | 200 | DAJK15P*-1U7N-146 | 112 | DAJT3WK3S9 | 129 |
| 995-0001-584 | 187 | DA121073-50 | 200 | DAJK15P*-OL4 | 120 | DAJT3WK3S9-1A0N | 125 |
| 995-0001-585 | 187 | DA15P-OL2-K87 | 10 | DAJK15S*-1A0N | 111 | DAJT3WK3S9-OL4 | 127 |
| 995-0001-604 | 187 | DA15P-1A5N-K87 | 26 | DAJK15S*-1A5N | 119 | DAJTE15P | 122 |
| 995-0001-739 | 187 | DA15P-1A6N-K87 | 26 | DAJK15S*-1A6N | 119 | DAJTE15S* | 123 |
| 995-0001-761 | 85 | DA15P-1A7N-K87 | 22 | DAJK15S*-1A7N | 115 | DAJTE3W3P1 | 128 |
| 995-2000-000 | 83 | DA15P-1A8N-K87 | 22 | DAJK15S*-1A8N | 115 | DAJTE3W3P1-1A0N | 124 |
| 995-2000-092 | 211 | DA15P-1A9N-K87 | 22 | DAJK15S*-1A9N | 115 | DAJTE3W3P1-OL4 | 126 |
| 995-2000-094 | 84 | DA15P-1ADN-K87 | 24 | DAJK15S*-1ADN | 117 | DAJTE3W3P5 | 128 |
| 995-2000-110 | 85 | DA15P-1AFN-K87 | 22 | DAJK15S*-1AFN | 115 | DAJTE3W3P5-1A0N | 124 |
| ABT-607 | 84 | DA15P-1AJN-K87 | 24 | DAJK15S*-1AGN | 117 | DAJTE3W3P5-OL4 | 126 |
| CA111972-11 | 98 | DA15P-1A0N-K87 | 20 | DAJK15S*-1AHN | 115 | DAJTE3W3P6 | 128 |

| Part Number | Page | Part Number | Page | Part Number | Page | Part Number | Page |
|------------------|------|---------------------|------|--------------------|------|--------------------|------|
| DAJTE3W3P6-1A0N | 124 | DAJTX3WK3S5-1A0N | 125 | DAM15PF | 134 | DAM7W2PNMBK52 | 195 |
| DAJTE3W3P6-OL4 | 126 | DAJTX3WK3S5-OL4 | 127 | DAM15PF179 | 138 | DAM7W2POL3NMBK52 | 195 |
| DAJTE3W3P9 | 128 | DAJTX3WK3S6 | 129 | DAM15PF179A | 138 | DAM7W2S-NMC-77 | 195 |
| DAJTE3W3P9-1A0N | 124 | DAJTX3WK3S6-1A0N | 125 | DAM15PF179ANMBK52 | 195 | DAM7W2S1A0NNMBK52 | 195 |
| DAJTE3W3P9-OL4 | 126 | DAJTX3WK3S6-OL4 | 127 | DAM15PG | 132 | DAM7W2S1A7NNMBK52 | 195 |
| DAJTE3W3S1 | 129 | DAJTX3WK3S9 | 129 | DAM15PH | 136 | DAM7W2S1A9NNMBK52 | 195 |
| DAJTE3W3S1-1A0N | 125 | DAJTX3WK3S9-1A0N | 125 | DAM15PK | 134 | DAM7W2SA197 | 79 |
| DAJTE3W3S1-OL4 | 127 | DAJTX3WK3S9-OL4 | 127 | DAM15PL | 132 | DAM7W2SF179ANMBK52 | 195 |
| DAJTE3W3S5 | 129 | DAM-11W1P-1A0N-K87 | 74 | DAM15PLNM | 174 | DAM7W2SNM | 189 |
| DAJTE3W3S5-1A0N | 125 | DAM-11W1P-1A7N-K87 | 74 | DAM15PM | 136 | DAM7W2SNMBK52 | 195 |
| DAJTE3W3S5-OL4 | 127 | DAM-11W1P-NMB-76 | 195 | DAM15PNM | 180 | DAM7W2SOL3NMBK52 | 195 |
| DAJTE3W3S6 | 129 | DAM-11W1P-NMB-77 | 195 | DAM15PNM*1A7N | 178 | DAMA15PNM | 182 |
| DAJTE3W3S6-1A0N | 125 | DAM-11W1P-NMC-76 | 195 | DAM15PNM*1A9N | 178 | DAMA15PNMBK52 | 195 |
| DAJTE3W3S6-OL4 | 127 | DAM-11W1P-NMC-77 | 195 | DAM15PNM*1A0N | 176 | DAMA15SNM | 183 |
| DAJTE3W3S9 | 129 | DAM-11W1P-OL2-K87 | 76 | DAM15PNMB76 | 195 | DAMA15SNMBK52 | 195 |
| DAJTE3W3S9-1A0N | 125 | DAM-11W1P-OL4-K87 | 76 | DAM15PNMB77 | 195 | DAMA26PNM | 184 |
| DAJTE3W3S9-OL4 | 127 | DAM-11W1S-1A0N-A197 | 75 | DAM15PNMBK52 | 195 | DAMAY26PNM | 184 |
| DAJTE3WK3P1 | 128 | DAM-11W1S-1A7N-A197 | 75 | DAM15PNMCC76 | 195 | DAMAY26SNM | 185 |
| DAJTE3WK3P1-1A0N | 124 | DAM-11W1S-NMB-76 | 195 | DAM15PNMC77 | 195 | DAMB-11W1S-NMB-77 | 195 |
| DAJTE3WK3P1-OL4 | 126 | DAM-11W1S-NMB-77 | 195 | DAM15POL3NM | 172 | DAMB-15S-NMC-77 | 195 |
| DAJTE3WK3P5 | 128 | DAM-11W1S-NMC-76 | 195 | DAM15POL3NMBK52 | 195 | DAMB-7W2S-NMB-76 | 195 |
| DAJTE3WK3P5-1A0N | 124 | DAM-11W1S-NMC-77 | 195 | DAM15PP | 134 | DAMB-7W2S-NMB-77 | 195 |
| DAJTE3WK3P5-OL4 | 126 | DAM-11W1S-OL2-A197 | 77 | DAM15PR | 134 | DAMB15SNMB77 | 195 |
| DAJTE3WK3P6 | 128 | DAM-11W1S-OL4-A197 | 77 | DAM15PS | 132 | DAMC11C1PJK87 | 44 |
| DAJTE3WK3P6-1A0N | 124 | DAM-15S-NMB-76 | 195 | DAM15PW | 132 | DAMC11C1PVK87 | 50 |
| DAJTE3WK3P6-OL4 | 126 | DAM-15S-NMC-76 | 195 | DAM15PX | 136 | DAMC11C1SJA197 | 45 |
| DAJTE3WK3P9 | 128 | DAM-3W3P-1A0N-K87 | 74 | DAM15PZ | 136 | DAMC11C1SVA197 | 51 |
| DAJTE3WK3P9-1A0N | 124 | DAM-3W3P-1A7N-K87 | 74 | DAM15S | 141 | DAMC11H1PK87 | 60 |
| DAJTE3WK3P9-OL4 | 126 | DAM-3W3P-NMB-76 | 195 | DAM15S1A0NNMBK52 | 195 | DAMC11H1SJA197 | 61 |
| DAJTE3WK3S1 | 129 | DAM-3W3P-NMC-76 | 195 | DAM15S1A7NNMBK52 | 195 | DAMC11P1PVK87 | 64 |
| DAJTE3WK3S1-1A0N | 125 | DAM-3W3P-OL2-K87 | 76 | DAM15SA | 133 | DAMC11P1SVA197 | 65 |
| DAJTE3WK3S1-OL4 | 127 | DAM-3W3P-OL4-K87 | 76 | DAM15SB | 137 | DAMC15PJK87 | 16 |
| DAJTE3WK3S5 | 129 | DAM-3W3S-1A0N-A197 | 75 | DAM15SC | 135 | DAMC15SJA197 | 17 |
| DAJTE3WK3S5-1A0N | 125 | DAM-3W3S-1A7N-A197 | 75 | DAM15SD | 133 | DAMC3C3PK87 | 44 |
| DAJTE3WK3S5-OL4 | 127 | DAM-3W3S-NMC-76 | 195 | DAM15SE | 137 | DAMC3C3PVK87 | 50 |
| DAJTE3WK3S6 | 129 | DAM-3W3S-OL2-A197 | 77 | DAM15SF | 135 | DAMC3C3SJA197 | 45 |
| DAJTE3WK3S6-1A0N | 125 | DAM-3W3S-OL4-A197 | 77 | DAM15SF179 | 139 | DAMC3C3SVA197 | 51 |
| DAJTE3WK3S6-OL4 | 127 | DAM-3WK3P-1A0N-K87 | 74 | DAM15SF179A | 139 | DAMC3C3SVA197TM | 51 |
| DAJTE3WK3S9 | 129 | DAM-3WK3P-1A7N-K87 | 74 | DAM15SF179ANMBK52 | 195 | DAMC3H3PK87 | 60 |
| DAJTE3WK3S9-1A0N | 125 | DAM-3WK3P-OL2-K87 | 76 | DAM15SG | 133 | DAMC3H3SJA197 | 61 |
| DAJTE3WK3S9-OL4 | 127 | DAM-3WK3P-OL4-K87 | 76 | DAM15SH | 137 | DAMC3H3PK87TM | 60 |
| DAJTX15P | 122 | DAM-3WK3S-1A0N-A197 | 75 | DAM15SK | 135 | DAMC3K3SJA197TM | 45 |
| DAJTX15S* | 123 | DAM-3WK3S-1A7N-A197 | 75 | DAM15SL | 133 | DAMC3K3SVA197TM | 51 |
| DAJTX3W3KP1-1A0N | 124 | DAM-3WK3S-OL2-A197 | 77 | DAM15SLNM | 175 | DAMC3H3PK87 | 60 |
| DAJTX3W3P1 | 128 | DAM-3WK3S-OL4-A197 | 77 | DAM15SM | 137 | DAMC3H3SJA197 | 61 |
| DAJTX3W3P1-1A0N | 124 | DAM-7W2P-1A0N-K87 | 74 | DAM15SNM | 181 | DAMC3HK3PK87TM | 60 |
| DAJTX3W3P1-OL4 | 126 | DAM-7W2P-1A7N-K87 | 74 | DAM15SNM*1A7N | 179 | DAMC3HK3SJA197TM | 61 |
| DAJTX3W3P5 | 128 | DAM-7W2P-NMB-76 | 195 | DAM15SNM*1A9N | 179 | DAMC3P3PVK87 | 64 |
| DAJTX3W3P5-1A0N | 124 | DAM-7W2P-NMB-77 | 195 | DAM15SNM*1A0N | 177 | DAMC3P3SVA197 | 65 |
| DAJTX3W3P5-OL4 | 126 | DAM-7W2P-OL2-K87 | 76 | DAM15SNMB77 | 195 | DAMC3P3PVK87TM | 64 |
| DAJTX3W3P6 | 128 | DAM-7W2P-OL4-K87 | 76 | DAM15SNMBK52 | 195 | DAMC3P3SVA197TM | 65 |
| DAJTX3W3P6-1A0N | 124 | DAM-7W2S-1A0N-A197 | 75 | DAM15SOL3NM | 173 | DAMC7C2PK87 | 44 |
| DAJTX3W3P6-OL4 | 126 | DAM-7W2S-1A7N-A197 | 75 | DAM15SOL3NMBK52 | 195 | DAMC7C2PVK87 | 50 |
| DAJTX3W3P9 | 128 | DAM-7W2S-1A7N-A197 | 75 | DAM15SP | 135 | DAMC7C2SJA197 | 45 |
| DAJTX3W3P9-1A0N | 124 | DAM-7W2S-NMB-77 | 195 | DAM15SR | 135 | DAMC7C2SVA197 | 51 |
| DAJTX3W3P9-OL4 | 126 | DAM-7W2S-NMC-76 | 195 | DAM15SS | 133 | DAMC7H2PK87 | 60 |
| DAJTX3W3S1 | 129 | DAM-7W2S-OL2-A197 | 77 | DAM15SW | 133 | DAMC7H2SJA197 | 61 |
| DAJTX3W3S1-1A0N | 125 | DAM-7W2S-OL4-A197 | 77 | DAM15SX | 137 | DAMC7P2PVK87 | 64 |
| DAJTX3W3S1-OL4 | 127 | DAM11W1P1A0NNMBK52 | 195 | DAM15SZ | 137 | DAMC7P2SVA197 | 65 |
| DAJTX3W3S5 | 129 | DAM11W1P1A7NNMBK52 | 195 | DAM3W3P-NMC-77 | 195 | DAMD11C1PVK87 | 50 |
| DAJTX3W3S5-1A0N | 125 | DAM11W1P1A9NNMBK52 | 195 | DAM3W3PK87 | 78 | DAMD11C1SJA197 | 45 |
| DAJTX3W3S5-OL4 | 127 | DAM11W1PF179ANMBK52 | 195 | DAM3W3PNM | 188 | DAMD11C1SVA197 | 51 |
| DAJTX3W3S6 | 129 | DAM11W1PK87 | 78 | DAM3W3PNMBK52 | 195 | DAMD11H1PK87 | 60 |
| DAJTX3W3S6-1A0N | 125 | DAM11W1PNM | 188 | DAM3W3PNMBK52 | 195 | DAMD11H1SJA197 | 61 |
| DAJTX3W3S6-OL4 | 127 | DAM11W1PNMBK52 | 195 | DAM3W3PNMC76 | 195 | DAMD11P1PVK87 | 64 |
| DAJTX3W3S9 | 129 | DAM11W1POL3NMBK52 | 195 | DAM3W3POL3NMBK52 | 195 | DAMD11P1SVA197 | 65 |
| DAJTX3W3S9-1A0N | 125 | DAM11W1S1A0NNMBK52 | 195 | DAM3W3S-NMC-76 | 195 | DAMD11H1PK87 | 60 |
| DAJTX3W3S9-OL4 | 127 | DAM11W1S1A7NNMBK52 | 195 | DAM3W3S-1A0N-A197 | 79 | DAMD11H1SJA197 | 61 |
| DAJTX3WK3P1 | 128 | DAM11W1S1A9NNMBK52 | 195 | DAM3W3SA197 | 79 | DAMD11P1PVK87 | 64 |
| DAJTX3WK3P1-OL4 | 126 | DAM11W1SA197 | 79 | DAM3W3SNM | 189 | DAMD11P1SVA197 | 65 |
| DAJTX3WK3P5 | 128 | DAM11W1SF179ANMBK52 | 195 | DAM3W3SNMB76 | 195 | DAMD15PJK87 | 16 |
| DAJTX3WK3P5-1A0N | 124 | DAM11W1SNM | 189 | DAM3W3SNMB77 | 195 | DAMD15SJA197 | 17 |
| DAJTX3WK3P5-OL4 | 126 | DAM11W1SNMBK52 | 195 | DAM3W3SNMBK52 | 195 | DAMD3C3PK87 | 44 |
| DAJTX3WK3P6 | 128 | DAM11W1SOL3NMBK52 | 195 | DAM3W3SNMBK52 | 195 | DAMD3C3PVK87 | 50 |
| DAJTX3WK3P6-1A0N | 124 | DAM15P | 140 | DAM3W3PK87 | 78 | DAMD3C3SJA197 | 45 |
| DAJTX3WK3P6-OL4 | 126 | DAM15P1A0NNMBK52 | 195 | DAM3W3PNM | 188 | DAMD3C3SVA197 | 51 |
| DAJTX3WK3P9 | 128 | DAM15P1A7NNMBK52 | 195 | DAM3W3PK87 | 78 | DAMD3C3PK87TM | 44 |
| DAJTX3WK3P9-1A0N | 124 | DAM15P1A9NNMBK52 | 195 | DAM53512-1405 | 49 | DAMD3CK3PVK87TM | 50 |
| DAJTX3WK3P9-OL4 | 126 | DAM15PA | 132 | DAM7W2P1A0NNMBK52 | 195 | DAMD3CK3SJA197TM | 45 |
| DAJTX3WK3S1 | 129 | DAM15PB | 136 | DAM7W2P1A7NNMBK52 | 195 | DAMD3CK3SVA197TM | 51 |
| DAJTX3WK3S1-1A0N | 125 | DAM15PC | 134 | DAM7W2P1A9NNMBK52 | 195 | DAMD3H3PK87 | 60 |
| DAJTX3WK3S1-OL4 | 127 | DAM15PD | 132 | DAM7W2PF179ANMBK52 | 195 | DAMD3H3SJA197 | 61 |
| DAJTX3WK3S5 | 129 | DAM15PE | 136 | DAM7W2PK87 | 78 | DAMD3HK3PK87TM | 60 |
| | | | | DAM7W2PNM | 188 | DAMD3HK3SJA197TM | 61 |

D Subminiature

Part Number Index

| Part Number | Page | Part Number | Page | Part Number | Page | Part Number | Page |
|------------------|------|--------------|------|-------------|------|------------------|------|
| DAMD3P3PVK87 | 64 | DAMM15SE | 137 | DAMMN11V1PN | 162 | DAMMZ3HK3SN | 159 |
| DAMD3P3SVA197 | 65 | DAMM15SF | 135 | DAMMN11V1SN | 163 | DAMMZ3V3PN | 162 |
| DAMD3PK3PVK87TM | 64 | DAMM15SF179 | 139 | DAMMN3C3PN | 150 | DAMMZ3V3SN | 163 |
| DAMD3PK3SVA197TM | 65 | DAMM15SF179A | 139 | DAMMN3C3SN | 151 | DAMMZ3VK3PN | 162 |
| DAMD7C2PJ87 | 44 | DAMM15SG | 133 | DAMMN3CK3PN | 150 | DAMMZ3VK3SN | 163 |
| DAMD7C2PVK87 | 50 | DAMM15SH | 137 | DAMMN3CK3SN | 151 | DAMMZ7C2PN | 150 |
| DAMD7C2SJA197 | 45 | DAMM15SK | 135 | DAMMN3H3PN | 158 | DAMMZ7C2SN | 151 |
| DAMD7C2SVA197 | 51 | DAMM15SL | 133 | DAMMN3H3SN | 159 | DAMMZ7H2PN | 158 |
| DAMD7H2PJK87 | 60 | DAMM15SM | 137 | DAMMN3HK3PN | 158 | DAMMZ7H2SN | 159 |
| DAMD7H2SJA197 | 61 | DAMM15SP | 135 | DAMMN3HK3SN | 159 | DAMMZ7V2PN | 162 |
| DAMD7P2PVK87 | 64 | DAMM15SR | 135 | DAMMN3V3PN | 162 | DAMMZ7V2SN | 163 |
| DAMD7P2SVA197 | 65 | DAMM15SS | 133 | DAMMN3V3SN | 163 | DAMN11C1PNK87 | 52 |
| DAME11W1PK87 | 78 | DAMM15SW | 133 | DAMMN3VK3PN | 162 | DAMN11C1PYK87 | 56 |
| DAME11W1SA197 | 79 | DAMM15SX | 137 | DAMMN3VK3SN | 163 | DAMN11C1SNA197 | 53 |
| DAME15P | 140 | DAMM15SZ | 137 | DAMMN7C2PN | 150 | DAMN11C1SYA197 | 57 |
| DAME15S | 141 | DAMM3W3P | 166 | DAMMN7C2SN | 151 | DAMN11H1PNK87 | 66 |
| DAME3W3PK87 | 78 | DAMM3W3S | 167 | DAMMN7H2PN | 158 | DAMN11H1PYK87 | 70 |
| DAME3W3SA197 | 79 | DAMM3WK3P | 166 | DAMMN7H2SN | 159 | DAMN11H1SNA197 | 67 |
| DAME3WK3PK87 | 78 | DAMM3WK3S | 167 | DAMMN7V2PN | 162 | DAMN11H1SYA197 | 71 |
| DAME3WK3SA197 | 79 | DAMM7W2P | 166 | DAMMN7V2SN | 163 | DAMN15PNK87 | 6 |
| DAME7W2PK87 | 78 | DAMM7W2S | 167 | DAMMP11C1PJ | 146 | DAMN15SNA197 | 7 |
| DAME7W2SA197 | 79 | DAMMC11C1PJ | 146 | DAMMP11C1SJ | 147 | DAMN3C3PNK87 | 52 |
| DAMG11C1PJ87 | 44 | DAMMC11C1SJ | 147 | DAMMP11H1PJ | 154 | DAMN3C3PYK87 | 56 |
| DAMG11C1PVK87 | 50 | DAMMC11H1PJ | 154 | DAMMP11H1SJ | 155 | DAMN3C3SNA197 | 53 |
| DAMG11C1SJA197 | 45 | DAMMC11H1SJ | 155 | DAMMP3C3PJ | 146 | DAMN3C3SYA197 | 57 |
| DAMG11C1SVA197 | 51 | DAMMC3C3PJ | 146 | DAMMP3C3SJ | 147 | DAMN3CK3PNK87TM | 52 |
| DAMG11H1PJ87 | 60 | DAMMC3C3SJ | 147 | DAMMP3CK3PJ | 146 | DAMN3CK3PYK87TM | 56 |
| DAMG11H1SJA197 | 61 | DAMMC3CK3PJ | 146 | DAMMP3CK3SJ | 147 | DAMN3CK3SNA197TM | 53 |
| DAMG11P1PVK87 | 64 | DAMMC3CK3SJ | 147 | DAMMP3H3PJ | 154 | DAMN3CK3SYA197TM | 57 |
| DAMG11P1SVA197 | 65 | DAMMC3H3PJ | 154 | DAMMP3H3SJ | 155 | DAMN3H3PNK87 | 66 |
| DAMG15PJ87 | 16 | DAMMC3H3SJ | 155 | DAMMP3HK3PJ | 154 | DAMN3H3PYK87 | 70 |
| DAMG15SJA197 | 17 | DAMMC3HK3PJ | 154 | DAMMP3HK3SJ | 155 | DAMN3H3SNA197 | 67 |
| DAMG3C3PJ87 | 44 | DAMMC3HK3SJ | 155 | DAMMP7C2PJ | 146 | DAMN3H3SYA197 | 71 |
| DAMG3C3PVK87 | 50 | DAMMC7C2PJ | 146 | DAMMP7C2SJ | 147 | DAMN3HK3PNK87TM | 66 |
| DAMG3C3SJA197 | 45 | DAMMC7C2SJ | 147 | DAMMP7H2PJ | 154 | DAMN3HK3PYK87TM | 70 |
| DAMG3C3SVA197 | 51 | DAMMC7H2PJ | 154 | DAMMP7H2SJ | 155 | DAMN3HK3SNA197TM | 67 |
| DAMG3CK3PJ87TM | 44 | DAMMC7H2SJ | 155 | DAMMV11C1PN | 150 | DAMN3HK3SYA197TM | 71 |
| DAMG3CK3PVK87TM | 50 | DAMMD11C1PJ | 146 | DAMMV11C1SN | 151 | DAMN7C2PNK87 | 52 |
| DAMG3CK3SJA197TM | 45 | DAMMD11C1SJ | 147 | DAMMV11H1PN | 158 | DAMN7C2PYK87 | 56 |
| DAMG3CK3SVA197TM | 51 | DAMMD11H1PJ | 154 | DAMMV11H1SN | 159 | DAMN7C2SNA197 | 53 |
| DAMG3H3PJ87 | 60 | DAMMD11H1SJ | 155 | DAMMV11V1PN | 162 | DAMN7C2SYA197 | 57 |
| DAMG3H3SJA197 | 61 | DAMMD3C3PJ | 146 | DAMMV11V1SN | 163 | DAMN7H2PNK87 | 66 |
| DAMG3HK3PJ87TM | 60 | DAMMD3C3SJ | 147 | DAMMV3C3PN | 150 | DAMN7H2PYK87 | 70 |
| DAMG3HK3SJA197TM | 61 | DAMMD3CK3PJ | 146 | DAMMV3C3SN | 151 | DAMN7H2SNA197 | 67 |
| DAMG3P3PVK87 | 64 | DAMMD3CK3SJ | 147 | DAMMV3CK3PN | 150 | DAMN7H2SYA197 | 71 |
| DAMG3P3SVA197 | 65 | DAMMD3H3PJ | 154 | DAMMV3CK3SN | 151 | DAMP11C1PJ87 | 44 |
| DAMG3PK3PVK87TM | 64 | DAMMD3H3SJ | 155 | DAMMV3H3PN | 158 | DAMP11C1PVK87 | 50 |
| DAMG3PK3SVA197TM | 65 | DAMMD3HK3PJ | 154 | DAMMV3H3SN | 159 | DAMP11C1SJA197 | 45 |
| DAMG7C2PJ87 | 44 | DAMMD3HK3SJ | 155 | DAMMV3HK3PN | 158 | DAMP11C1SVA197 | 51 |
| DAMG7C2PVK87 | 50 | DAMMD7C2PJ | 146 | DAMMV3HK3SN | 159 | DAMP11H1PJ87 | 60 |
| DAMG7C2SJA197 | 45 | DAMMD7C2SJ | 147 | DAMMV3V3PN | 162 | DAMP11H1SJA197 | 61 |
| DAMG7C2SVA197 | 51 | DAMMD7H2PJ | 154 | DAMMV3V3SN | 163 | DAMP11P1PVK87 | 64 |
| DAMG7H2PJK87 | 60 | DAMMD7H2SJ | 155 | DAMMV3VK3PN | 162 | DAMP11P1SVA197 | 65 |
| DAMG7H2SJA197 | 61 | DAMME11W1P | 166 | DAMMV3VK3SN | 163 | DAMP15PJ87 | 16 |
| DAMG7P2PVK87 | 64 | DAMME11W1S | 167 | DAMMV7C2PN | 150 | DAMP15SJA197 | 17 |
| DAMG7P2SVA197 | 65 | DAMME15P | 140 | DAMMV7C2SN | 151 | DAMP3C3PJ87 | 44 |
| DAMM11W1P | 166 | DAMME15S | 141 | DAMMV7H2PN | 158 | DAMP3C3PVK87 | 50 |
| DAMM11W1S | 167 | DAMME3W3P | 166 | DAMMV7H2SN | 159 | DAMP3C3SJA197 | 45 |
| DAMM15P | 140 | DAMME3W3S | 167 | DAMMV7V2PN | 162 | DAMP3C3SVA197 | 51 |
| DAMM15PA | 132 | DAMME3WK3P | 166 | DAMMV7V2SN | 163 | DAMP3CK3PJ87TM | 44 |
| DAMM15PB | 136 | DAMME3WK3S | 167 | DAMMY11W1P | 166 | DAMP3CK3PVK87TM | 50 |
| DAMM15PC | 134 | DAMME7W2P | 166 | DAMMY11W1S | 167 | DAMP3CK3SJA197TM | 45 |
| DAMM15PD | 132 | DAMME7W2S | 167 | DAMMY15P | 140 | DAMP3CK3SVA197TM | 51 |
| DAMM15PE | 136 | DAMMG11C1PJ | 146 | DAMMY15S | 141 | DAMP3H3PJ87 | 60 |
| DAMM15PF | 134 | DAMMG11C1SJ | 147 | DAMMY3W3P | 166 | DAMP3H3SJA197 | 61 |
| DAMM15PF179 | 138 | DAMMG11H1PJ | 154 | DAMMY3W3S | 167 | DAMP3HK3PJ87TM | 60 |
| DAMM15PF179A | 138 | DAMMG11H1SJ | 155 | DAMMY3WK3P | 166 | DAMP3HK3SJA197TM | 61 |
| DAMM15PG | 132 | DAMMG3C3PJ | 146 | DAMMY3WK3S | 167 | DAMP3P3PVK87 | 64 |
| DAMM15PH | 136 | DAMMG3C3SJ | 147 | DAMMY7W2P | 166 | DAMP3P3SVA197 | 65 |
| DAMM15PK | 134 | DAMMG3CK3PJ | 146 | DAMMY7W2S | 167 | DAMP3PK3PVK87TM | 64 |
| DAMM15PL | 132 | DAMMG3CK3SJ | 147 | DAMMZ11C1PN | 150 | DAMP3PK3SVA197TM | 65 |
| DAMM15PM | 136 | DAMMG3H3PJ | 154 | DAMMZ11C1SN | 151 | DAMP7C2PJ87 | 44 |
| DAMM15PP | 134 | DAMMG3H3SJ | 155 | DAMMZ11H1PN | 158 | DAMP7C2PVK87 | 50 |
| DAMM15PR | 134 | DAMMG3HK3PJ | 154 | DAMMZ11H1SN | 159 | DAMP7C2SJA197 | 45 |
| DAMM15PS | 132 | DAMMG3HK3SJ | 155 | DAMMZ11V1PN | 162 | DAMP7C2SVA197 | 51 |
| DAMM15PW | 132 | DAMMG7C2PJ | 146 | DAMMZ11V1SN | 163 | DAMP7H2PJK87 | 60 |
| DAMM15PX | 136 | DAMMG7C2SJ | 147 | DAMMZ3C3PN | 150 | DAMP7H2SJA197 | 61 |
| DAMM15PZ | 136 | DAMMG7H2PJ | 154 | DAMMZ3C3SN | 151 | DAMP7P2PVK87 | 64 |
| DAMM15S | 141 | DAMMG7H2SJ | 155 | DAMMZ3CK3PN | 150 | DAMP7P2SVA197 | 65 |
| DAMM15SA | 133 | DAMMN11C1PN | 150 | DAMMZ3CK3SN | 151 | DAMV11C1PNK87 | 52 |
| DAMM15SB | 137 | DAMMN11C1SN | 151 | DAMMZ3H3PN | 158 | DAMV11C1PYK87 | 56 |
| DAMM15SC | 135 | DAMMN11H1PN | 158 | DAMMZ3H3SN | 159 | DAMV11C1SNA197 | 53 |
| DAMM15SD | 133 | DAMMN11H1SN | 159 | DAMMZ3HK3PN | 158 | DAMV11C1SYA197 | 57 |

D Subminiature

Part Number Index

| Part Number | Page | Part Number | Page | Part Number | Page | Part Number | Page |
|------------------|------|---------------------|----------|---------------------|------|---------------------|------|
| DAMV1H1PNK87 | 66 | DAMZ7C2SYA197 | 57 | DB25SA197 | 33 | DBJT25P | 122 |
| DAMV1H1PYK87 | 70 | DAMZ7H2PNK87 | 66 | DB50906-1 | 218 | DBJT25S* | 123 |
| DAMV1H1SNA197 | 67 | DAMZ7H2PYK87 | 70 | DB51212 | 206 | DBM-13W3P-1A0N-K87 | 74 |
| DAMV1H1SYA197 | 71 | DAMZ7H2SNA197 | 67 | DB51213 | 206 | DBM-13W3P-1A7N-K87 | 74 |
| DAMV15PNK87 | 6 | DAMZ7H2SYA197 | 71 | DB51221-1 | 210 | DBM-13W3P-NMB-76 | 195 |
| DAMV15SNA197 | 7 | DANG15P-P1 | 4 | DB51226-1B | 206 | DBM-13W3P-NMC-76 | 195 |
| DAMV3C3PNK87 | 52 | DANG15S-P1 | 5 | DB53750-2 | 218 | DBM-13W3P-OL2-K87 | 76 |
| DAMV3C3PYK87 | 56 | DANGE15P-P1 | 4 | DBA13W3PK87FO | 80 | DBM-13W3P-OL4-K87 | 76 |
| DAMV3C3SNA197 | 53 | DANGE15S-P1 | 5 | DBA13W3SA197FO | 81 | DBM-13W3S-1A0N-A197 | 75 |
| DAMV3C3SYA197 | 57 | DANGL15P-P1 | 4 | DBA17W2PK87FO | 80 | DBM-13W3S-1A7N-A197 | 75 |
| DAMV3CK3PNK87TM | 52 | DANGL15S-P1 | 5 | DBA17W2SA197FO | 81 | DBM-13W3S-NMB-77 | 195 |
| DAMV3CK3PYK87TM | 56 | DANGX15P-P1 | 4 | DBA21W1PK87FO | 80 | DBM-13W3S-NMC-76 | 195 |
| DAMV3CK3SNA197TM | 53 | DANGX15S-P1 | 5 | DBA21W1SA197FO | 81 | DBM-13W3S-OL2-A197 | 77 |
| DAMV3CK3SYA197TM | 57 | DANGZ15P-P1 | 4 | DBA25PK87FO | 36 | DBM-13W3S-OL4-A197 | 77 |
| DAMV3H3PNK87 | 66 | DANGZ15S-P1 | 5 | DBA25SA197FO | 37 | DBM-17W2P-1A0N-K87 | 74 |
| DAMV3H3PYK87 | 70 | DAW15P* | 38 | DBA5W5PK87FO | 80 | DBM-17W2P-1A7N-K87 | 74 |
| DAMV3H3SNA197 | 67 | DAW15P*G | 38 | DBA5W5SA197FO | 81 | DBM-17W2P-NMB-76 | 195 |
| DAMV3H3SYA197 | 71 | DAW15S* | 39 | DBA9W4PK87FO | 80 | DBM-17W2P-NMC-76 | 195 |
| DAMV3HK3PNK87TM | 66 | DAW15S*G | 39 | DBA9W4SA197FO | 81 | DBM-17W2P-OL2-K87 | 76 |
| DAMV3HK3PYK87TM | 70 | DAWE15P* | 38 | DBBS-25 | 205 | DBM-17W2P-OL4-K87 | 76 |
| DAMV3HK3SNA197TM | 67 | DAWE15P*G | 38 | DBBU111511 | 216 | DBM-17W2S-1A0N-A197 | 75 |
| DAMV3HK3SYA197TM | 71 | DAWE15S* | 39 | DBE25P-OL2-K87-146 | 10 | DBM-17W2S-1A7N-A197 | 75 |
| DAMV7C2PNK87 | 52 | DAWE15S*G | 39 | DBE25PK87 | 32 | DBM-17W2S-NMC-76 | 195 |
| DAMV7C2PYK87 | 56 | DAX15P-OL2-K87-146 | 10 | DBE25S-OL2-A197-146 | 11 | DBM-17W2S-NMC-77 | 195 |
| DAMV7C2SNA197 | 53 | DAX15PK87 | 32 | DBE25SA197 | 33 | DBM-17W2S-OL2-A197 | 77 |
| DAMV7C2SYA197 | 57 | DAX15S-OL2-A197-146 | 11 | DBJK25P*-1A0N | 110 | DBM-17W2S-OL4-A197 | 77 |
| DAMV7H2PNK87 | 66 | DAX15SA197 | 33 | DBJK25P*-1A5N | 118 | DBM-21W1P-1A0N-K87 | 74 |
| DAMV7H2PYK87 | 70 | DB-59-20 | 195, 218 | DBJK25P*-1A6N | 118 | DBM-21W1P-1A7N-K87 | 74 |
| DAMV7H2SNA197 | 67 | DB-60-20 | 195, 218 | DBJK25P*-1A7N | 114 | DBM-21W1P-NMB-76 | 195 |
| DAMV7H2SYA197 | 71 | DB111807-1 | 216 | DBJK25P*-1A8N | 114 | DBM-21W1P-NMC-77 | 195 |
| DAMY11W1PK87 | 78 | DB111807-5 | 216 | DBJK25P*-1A9N | 114 | DBM-21W1P-OL2-K87 | 76 |
| DAMY11W1PNM | 188 | DB111811 | 216 | DBJK25P*-1ADN | 116 | DBM-21W1P-OL4-K87 | 76 |
| DAMY11W1SA197 | 79 | DB111811-2 | 216 | DBJK25P*-1AFN | 114 | DBM-21W1S-1A0N-A197 | 75 |
| DAMY11W1SNM | 189 | DB111949-43 | 48 | DBJK25P*-1AGN | 116 | DBM-21W1S-1A7N-A197 | 75 |
| DAMY15P | 140 | DB115339-2 | 207 | DBJK25P*-1AHN | 114 | DBM-21W1S-NMB-76 | 195 |
| DAMY15PNM | 180 | DB115339-22 | 205 | DBJK25P*-1AJN | 116 | DBM-21W1S-NMC-76 | 195 |
| DAMY15PNM*1A0N | 176 | DB115386-102A | 195 | DBJK25P*-1APN | 118 | DBM-21W1S-OL2-A197 | 77 |
| DAMY15POL3NM | 172 | DB115386-3B | 207 | DBJK25P*-1ATN | 118 | DBM-21W1S-OL4-A197 | 77 |
| DAMY15S | 141 | DB121073-151 | 200 | DBJK25P*-1AUN | 118 | DBM-25S-NMB-76 | 195 |
| DAMY15SNM | 181 | DB121073-51 | 200 | DBJK25P*-1AVN | 116 | DBM-25S-NMC-76 | 195 |
| DAMY15SNM*1A0N | 177 | DB19678-168 | 193, 195 | DBJK25P*-1AWN | 116 | DBM-25S-NMC-77 | 195 |
| DAMY15SOL3NM | 173 | DB19678-171 | 195 | DBJK25P*-1U0N | 108 | DBM-5W5P-1A0N-K87 | 74 |
| DAMY3W3PK87 | 78 | DB19678-175 | 195 | DBJK25P*-1U7N | 112 | DBM-5W5P-1A7N-K87 | 74 |
| DAMY3W3PNM | 188 | DB19678-2 | 204 | DBJK25P*-1U7N-146 | 112 | DBM-5W5P-NMB-76 | 195 |
| DAMY3W3SA197 | 79 | DB19977-2 | 204 | DBJK25P*-OL4 | 120 | DBM-5W5P-NMC-76 | 195 |
| DAMY3W3SNM | 189 | DB19977-43 | 193, 195 | DBJK25S*-1A0N | 111 | DBM-5W5P-NMC-77 | 195 |
| DAMY3WK3PK87 | 78 | DB20962 | 203 | DBJK25S*-1A5N | 119 | DBM-5W5P-OL2-K87 | 76 |
| DAMY3WK3PNM | 188 | DB20962-18 | 192 | DBJK25S*-1A6N | 119 | DBM-5W5P-OL4-K87 | 76 |
| DAMY3WK3SA197 | 79 | DB22254 | 214 | DBJK25S*-1A7N | 115 | DBM-5W5S-1A0N-A197 | 75 |
| DAMY3WK3SNM | 189 | DB22255 | 215 | DBJK25S*-1A8N | 115 | DBM-5W5S-1A7N-A197 | 75 |
| DAMY7W2PK87 | 78 | DB24659 | 203 | DBJK25S*-1A9N | 115 | DBM-5W5S-NMB-76 | 195 |
| DAMY7W2PNM | 188 | DB24659-15 | 192, 195 | DBJK25S*-1ADN | 117 | DBM-5W5S-NMC-77 | 195 |
| DAMY7W2SA197 | 79 | DB25P-OL2-K87 | 10 | DBJK25S*-1AFN | 115 | DBM-5W5S-NMC-76 | 195 |
| DAMY7W2SNM | 189 | DB25P-1A5N-K87 | 26 | DBJK25S*-1AGN | 117 | DBM-5W5S-NMC-77 | 195 |
| DAMZ11C1PNK87 | 52 | DB25P-1A6N-K87 | 26 | DBJK25S*-1AHN | 115 | DBM-5W5S-NMC-77 | 195 |
| DAMZ11C1PYK87 | 56 | DB25P-1A7N-K87 | 22 | DBJK25S*-1AJN | 117 | DBM-5W5S-OL2-A197 | 77 |
| DAMZ11C1SNA197 | 53 | DB25P-1A8N-K87 | 22 | DBJK25S*-1APN | 119 | DBM-5W5S-OL4-A197 | 77 |
| DAMZ11C1SYA197 | 57 | DB25P-1A9N-K87 | 22 | DBJK25S*-1ATN | 119 | DBM-9W4P-1A0N-K87 | 74 |
| DAMZ11H1PNK87 | 66 | DB25P-1ADN-K87 | 24 | DBJK25S*-1AUN | 119 | DBM-9W4P-1A7N-K87 | 74 |
| DAMZ11H1PYK87 | 70 | DB25P-1AFN-K87 | 22 | DBJK25S*-1AVN | 117 | DBM-9W4P-NMB-77 | 195 |
| DAMZ11H1SNA197 | 67 | DB25P-1AJN-K87 | 24 | DBJK25S*-1AWN | 117 | DBM-9W4P-NMC-76 | 195 |
| DAMZ11H1SYA197 | 71 | DB25P-1A0N-K87 | 20 | DBJK25S*-1U0N | 109 | DBM-9W4P-OL2-K87 | 76 |
| DAMZ15PNK87 | 6 | DB25P-1ATN-K87 | 26 | DBJK25S*-1U7N | 113 | DBM-9W4P-OL4-K87 | 76 |
| DAMZ15SNA197 | 7 | DB25P-1AUN-K87 | 26 | DBJK25S*-1U7N-146 | 113 | DBM-9W4S-1A0N-A197 | 75 |
| DAMZ3C3PNK87 | 52 | DB25P-1AVN-K87 | 24 | DBJK25S*-OL4 | 121 | DBM-9W4S-1A7N-A197 | 75 |
| DAMZ3C3PYK87 | 56 | DB25P-1AWN-K87 | 24 | DBJKE25P*-1A0N | 110 | DBM-9W4S-NMB-77 | 195 |
| DAMZ3C3SNA197 | 53 | DB25P-F179A-K87 | 12 | DBJKE25P*-1U0N | 108 | DBM-9W4S-NMC-76 | 195 |
| DAMZ3C3SYA197 | 57 | DB25PK87 | 32 | DBJKE25P*-OL4 | 120 | DBM-9W4S-OL2-A197 | 77 |
| DAMZ3CK3PNK87TM | 52 | DB25S-OL2-A197 | 11 | DBJKE25P*-OL4-146 | 120 | DBM-9W4S-OL4-A197 | 77 |
| DAMZ3CK3PYK87TM | 56 | DB25S-1A5N-A197 | 27 | DBJKE25S*-1A0N | 111 | DBM13W3P-NMB-77 | 195 |
| DAMZ3CK3SNA197TM | 53 | DB25S-1A6N-A197 | 27 | DBJKE25S*-1U0N | 109 | DBM13W3P1A0NNMBK52 | 195 |
| DAMZ3CK3SYA197TM | 57 | DB25S-1A7N-A197 | 23 | DBJKE25S*-OL4 | 121 | DBM13W3P1A7NNMBK52 | 195 |
| DAMZ3H3PNK87 | 66 | DB25S-1A8N-A197 | 23 | DBJKE25S*-OL4-146 | 121 | DBM13W3P1A9NNMBK52 | 195 |
| DAMZ3H3PYK87 | 70 | DB25S-1A9N-A197 | 23 | DBJX25P*-1A0N | 110 | DBM13W3PF179ANMBK52 | 195 |
| DAMZ3H3SNA197 | 67 | DB25S-1ADN-A197 | 25 | DBJX25P*-OL4 | 120 | DBM13W3PK87 | 78 |
| DAMZ3H3SYA197 | 71 | DB25S-1AFN-A197 | 23 | DBJX25P*-OL4-146 | 120 | DBM13W3PNM | 188 |
| DAMZ3HK3PNK87TM | 66 | DB25S-1AJN-A197 | 25 | DBJX25S*-1A0N | 111 | DBM13W3PNMBK52 | 195 |
| DAMZ3HK3PYK87TM | 70 | DB25S-1A0N-A197 | 21 | DBJX25S*-OL4 | 121 | DBM13W3POL3NMBK52 | 195 |
| DAMZ3HK3SNA197TM | 67 | DB25S-1ATN-A197 | 27 | DBJX25S*-OL4-146 | 121 | DBM13W3S-NMB-76 | 195 |
| DAMZ3HK3SYA197TM | 71 | DB25S-1AUN-A197 | 27 | DBJT25P | 122 | DBM13W3S1A0NNMBK52 | 195 |
| DAMZ7C2PNK87 | 52 | DB25S-1AVN-A197 | 25 | DBJT25S* | 123 | DBM13W3S1A7NNMBK52 | 195 |
| DAMZ7C2PYK87 | 56 | DB25S-1AWN-A197 | 25 | DBJTE25P | 122 | DBM13W3S1A9NNMBK52 | 195 |
| DAMZ7C2SNA197 | 53 | DB25S-F179A-A197 | 13 | DBJTE25S* | 123 | DBM13W3SA197 | 79 |

D Subminiature

Part Number Index

| Part Number | Page | Part Number | Page | Part Number | Page | Part Number | Page |
|---------------------|------|--------------------|------|----------------|------|----------------|------|
| DBM13W3SF179ANMBK52 | 195 | DBM25SE | 137 | DBMC21P1SVA197 | 65 | DBMG17C2SJA197 | 45 |
| DBM13W3SNM | 189 | DBM25SF | 135 | DBMC25PJK87 | 16 | DBMG17C2SVA197 | 51 |
| DBM13W3SNMBK52 | 195 | DBM25SF179 | 139 | DBMC25SJA197 | 17 | DBMG17H2PJK87 | 60 |
| DBM13W3SOL3NMBK52 | 195 | DBM25SF179A | 139 | DBMC5C5PJK87 | 44 | DBMG17H2SJA197 | 61 |
| DBM17W2P-NMC-77 | 195 | DBM25SF179ANMBK52 | 195 | DBMC5C5PVK87 | 50 | DBMG17P2PVK87 | 64 |
| DBM17W2P1A0NNMBK52 | 195 | DBM25SG | 133 | DBMC5C5SJA197 | 45 | DBMG17P2SVA197 | 65 |
| DBM17W2P1A7NNMBK52 | 195 | DBM25SH | 137 | DBMC5C5SVA197 | 51 | DBMG21C1PJK87 | 44 |
| DBM17W2P1A9NNMBK52 | 195 | DBM25SK | 135 | DBMC5H5PJK87 | 60 | DBMG21C1PVK87 | 50 |
| DBM17W2PF179ANMBK52 | 195 | DBM25SL | 133 | DBMC5H5SJA197 | 61 | DBMG21C1SJA197 | 45 |
| DBM17W2PK87 | 78 | DBM25SLNM | 175 | DBMC5P5PVK87 | 64 | DBMG21C1SVA197 | 51 |
| DBM17W2PNM | 188 | DBM25SM | 137 | DBMC5P5SVA197 | 65 | DBMG21H1PJK87 | 60 |
| DBM17W2PNMB77 | 195 | DBM25SNM | 181 | DBMC9C4PJK87 | 44 | DBMG21H1SJA197 | 61 |
| DBM17W2PNMBK52 | 195 | DBM25SNM**1A7N | 179 | DBMC9C4PVK87 | 50 | DBMG21P1PVK87 | 64 |
| DBM17W2POL3NMBK52 | 195 | DBM25SNM**1A9N | 179 | DBMC9C4SJA197 | 45 | DBMG21P1SVA197 | 65 |
| DBM17W2S1A0NNMBK52 | 195 | DBM25SNM**1A0N | 177 | DBMC9C4SVA197 | 51 | DBMG25PJK87 | 16 |
| DBM17W2S1A7NNMBK52 | 195 | DBM25SNMBK52 | 195 | DBMC9H4PJK87 | 60 | DBMG25SJA197 | 17 |
| DBM17W2S1A9NNMBK52 | 195 | DBM25SOL3NM | 173 | DBMC9H4SJA197 | 61 | DBMG5C5PJK87 | 44 |
| DBM17W2SA197 | 79 | DBM25SOL3NMBK52 | 195 | DBMC9P4PVK87 | 64 | DBMG5C5PVK87 | 50 |
| DBM17W2SF179ANMBK52 | 195 | DBM25SP | 135 | DBMC9P4SVA197 | 65 | DBMG5C5SJA197 | 45 |
| DBM17W2SNM | 189 | DBM25SR | 135 | DBMD13C3PJK87 | 44 | DBMG5C5SVA197 | 51 |
| DBM17W2SNMB77 | 195 | DBM25SS | 133 | DBMD13C3PVK87 | 50 | DBMG5H5PJK87 | 60 |
| DBM17W2SNMBK52 | 195 | DBM25SW | 133 | DBMD13C3SJA197 | 45 | DBMG5H5SJA197 | 61 |
| DBM17W2SOL3NMBK52 | 195 | DBM25SX | 137 | DBMD13C3SVA197 | 51 | DBMG5P5PVK87 | 64 |
| DBM21W1P1A0NNMBK52 | 195 | DBM25SZ | 137 | DBMD13H3PJK87 | 60 | DBMG5P5SVA197 | 65 |
| DBM21W1P1A7NNMBK52 | 195 | DBM5W5PNMB77 | 195 | DBMD13H3SJA197 | 61 | DBMG9C4PJK87 | 44 |
| DBM21W1P1A9NNMBK52 | 195 | DBM5W5PNMBK52 | 195 | DBMD13P3PVK87 | 64 | DBMG9C4PVK87 | 50 |
| DBM21W1PF179ANMBK52 | 195 | DBM5W5SA197 | 79 | DBMD13P3SVA197 | 65 | DBMG9C4SJA197 | 45 |
| DBM21W1PK87 | 78 | DBM5W5SNM | 189 | DBMD17C2PJK87 | 44 | DBMG9C4SVA197 | 51 |
| DBM21W1PNM | 188 | DBM5W5SNMBK52 | 195 | DBMD17C2PVK87 | 50 | DBMG9H4PJK87 | 60 |
| DBM21W1PNMBK52 | 195 | DBM9W4P1A0NNMBK52 | 195 | DBMD17C2SJA197 | 45 | DBMG9H4SJA197 | 61 |
| DBM21W1POL3NMBK52 | 195 | DBM9W4P1A7NNMBK52 | 195 | DBMD17C2SVA197 | 51 | DBMG9P4PVK87 | 64 |
| DBM21W1S1A0NNMBK52 | 195 | DBM9W4P1A9NNMBK52 | 195 | DBMD17H2PJK87 | 60 | DBMG9P4SVA197 | 65 |
| DBM21W1S1A7NNMBK52 | 195 | DBM9W4PF179ANMBK52 | 195 | DBMD17H2SJA197 | 61 | DBMM13W3P | 166 |
| DBM21W1S1A9NNMBK52 | 195 | DBM9W4PK87 | 78 | DBMD17P2PVK87 | 64 | DBMM13W3S | 167 |
| DBM21W1SA197 | 79 | DBM9W4PNM | 188 | DBMD17P2SVA197 | 65 | DBMM17W2P | 166 |
| DBM21W1SF179ANMBK52 | 195 | DBM9W4PNMBK52 | 195 | DBMD21C1PJK87 | 44 | DBMM17W2S | 167 |
| DBM21W1SNM | 189 | DBM9W4POL3NMBK52 | 195 | DBMD21C1PVK87 | 50 | DBMM21W1P | 166 |
| DBM21W1SNMBK52 | 195 | DBM9W4S1A0NNMBK52 | 195 | DBMD21C1SJA197 | 45 | DBMM21W1S | 167 |
| DBM21W1SOL3NMBK52 | 195 | DBM9W4S1A7NNMBK52 | 195 | DBMD21C1SVA197 | 51 | DBMM25P | 140 |
| DBM25P | 140 | DBM9W4S1A9NNMBK52 | 195 | DBMD21H1PJK87 | 60 | DBMM25PA | 132 |
| DBM25P1A0NNMBK52 | 195 | DBM9W4SA197 | 79 | DBMD21H1SJA197 | 61 | DBMM25PB | 136 |
| DBM25P1A7NNMBK52 | 195 | DBM9W4SF179ANMBK52 | 195 | DBMD21P1PVK87 | 64 | DBMM25PC | 134 |
| DBM25P1A9NNMBK52 | 195 | DBM9W4SNM | 189 | DBMD21P1SVA197 | 65 | DBMM25PD | 132 |
| DBM25PA | 132 | DBM9W4SNMBK52 | 195 | DBMD25PJK87 | 16 | DBMM25PE | 136 |
| DBM25PB | 136 | DBM9W4SOL3NMBK52 | 195 | DBMD25SJA197 | 17 | DBMM25PF | 134 |
| DBM25PC | 134 | DBMA25PNM | 182 | DBMD5C5PJK87 | 44 | DBMM25PF179 | 138 |
| DBM25PD | 132 | DBMA25PNMBK52 | 195 | DBMD5C5PVK87 | 50 | DBMM25PF179A | 138 |
| DBM25PE | 136 | DBMA25SNM | 183 | DBMD5C5SJA197 | 45 | DBMM25PG | 132 |
| DBM25PF | 134 | DBMA25SNMBK52 | 195 | DBMD5C5SVA197 | 51 | DBMM25PH | 136 |
| DBM25PF179 | 138 | DBMA44PNM | 184 | DBMD5H5PJK87 | 60 | DBMM25PK | 134 |
| DBM25PF179A | 138 | DBMA44SNM | 185 | DBMD5H5SJA197 | 61 | DBMM25PL | 132 |
| DBM25PF179ANMBK52 | 195 | DBMAY25PNM | 182 | DBMD5P5PVK87 | 64 | DBMM25PM | 136 |
| DBM25PG | 132 | DBMAY25SNM | 183 | DBMD5P5SVA197 | 65 | DBMM25PP | 134 |
| DBM25PH | 136 | DBMAY44PNM | 184 | DBMD9C4PJK87 | 44 | DBMM25PR | 134 |
| DBM25PK | 134 | DBMAY44SNM | 185 | DBMD9C4PVK87 | 50 | DBMM25PS | 132 |
| DBM25PL | 132 | DBMB-17W2S-NMB-76 | 195 | DBMD9C4SJA197 | 45 | DBMM25PW | 132 |
| DBM25PLNM | 174 | DBMB-25S-NMB-76 | 195 | DBMD9C4SVA197 | 51 | DBMM25PX | 136 |
| DBM25PM | 136 | DBMB-25S-NMB-77 | 195 | DBMD9H4PJK87 | 60 | DBMM25PZ | 136 |
| DBM25PNM | 180 | DBMB-25S-NMC-77 | 195 | DBMD9H4SJA197 | 61 | DBMM25S | 141 |
| DBM25PNM*1A7N | 178 | DBMB25SNMC76 | 195 | DBMD9P4PVK87 | 64 | DBMM25SA | 133 |
| DBM25PNM*1A9N | 178 | DBMC13C3PJK87 | 44 | DBMD9P4SVA197 | 65 | DBMM25SB | 137 |
| DBM25PNM*1A0N | 176 | DBMC13C3PVK87 | 50 | DBME13W3PK87 | 78 | DBMM25SC | 135 |
| DBM25PNMB76 | 195 | DBMC13C3SJA197 | 45 | DBME13W3SA197 | 79 | DBMM25SD | 133 |
| DBM25PNMB77 | 195 | DBMC13C3SVA197 | 51 | DBME17W2PK87 | 78 | DBMM25SE | 137 |
| DBM25PNMBK52 | 195 | DBMC13H3PJK87 | 60 | DBME17W2SA197 | 79 | DBMM25SF | 135 |
| DBM25PNMC76 | 195 | DBMC13H3SJA197 | 61 | DBME21W1PK87 | 78 | DBMM25SF179 | 139 |
| DBM25PNMC77 | 195 | DBMC13P3PVK87 | 64 | DBME21W1SA197 | 79 | DBMM25SF179A | 139 |
| DBM25POL3NM | 172 | DBMC13P3SVA197 | 65 | DBME25P | 140 | DBMM25SG | 133 |
| DBM25POL3NMBK52 | 195 | DBMC17C2PJK87 | 44 | DBME25S | 141 | DBMM25SH | 137 |
| DBM25PP | 134 | DBMC17C2PVK87 | 50 | DBME5W5PK87 | 78 | DBMM25SK | 135 |
| DBM25PR | 134 | DBMC17C2SJA197 | 45 | DBME5W5SA197 | 79 | DBMM25SL | 133 |
| DBM25PS | 132 | DBMC17C2SVA197 | 51 | DBME9W4PK87 | 78 | DBMM25SM | 137 |
| DBM25PW | 132 | DBMC17H2PJK87 | 60 | DBME9W4SA197 | 79 | DBMM25SP | 135 |
| DBM25PX | 136 | DBMC17H2SJA197 | 61 | DBMG13C3PJK87 | 44 | DBMM25SR | 135 |
| DBM25PZ | 136 | DBMC17P2PVK87 | 64 | DBMG13C3PVK87 | 50 | DBMM25SS | 133 |
| DBM25S | 141 | DBMC17P2SVA197 | 65 | DBMG13C3SJA197 | 45 | DBMM25SW | 133 |
| DBM25S1A0NNMBK52 | 195 | DBMC21C1PJK87 | 44 | DBMG13C3SVA197 | 51 | DBMM25SX | 137 |
| DBM25S1A7NNMBK52 | 195 | DBMC21C1PVK87 | 50 | DBMG13H3PJK87 | 60 | DBMM25SZ | 137 |
| DBM25S1A9NNMBK52 | 195 | DBMC21C1SJA197 | 45 | DBMG13H3SJA197 | 61 | DBMM5W5S | 167 |
| DBM25SA | 133 | DBMC21C1SVA197 | 51 | DBMG13P3PVK87 | 64 | DBMM9W4P | 166 |
| DBM25SB | 137 | DBMC21H1PJK87 | 60 | DBMG13P3SVA197 | 65 | DBMM9W4S | 167 |
| DBM25SC | 135 | DBMC21H1SJA197 | 61 | DBMG17C2PJK87 | 44 | DBMMC13C3PJ | 146 |
| DBM25SD | 133 | DBMC21P1PVK87 | 64 | DBMG17C2PVK87 | 50 | DBMMC13C3SJ | 147 |

| Part Number | Page | Part Number | Page | Part Number | Page | Part Number | Page |
|-------------|------|--------------|------|----------------|------|----------------|------|
| DBMMC13H3PJ | 154 | DBMMN21C1SN | 151 | DBMMZ13H3SN | 159 | DBMP17P2PVK87 | 64 |
| DBMMC13H3SJ | 155 | DBMMN21H1PN | 158 | DBMMZ13V3PN | 162 | DBMP17P2SVA197 | 65 |
| DBMMC17C2PJ | 146 | DBMMN21H1SN | 159 | DBMMZ13V3SN | 163 | DBMP21C1PJK87 | 44 |
| DBMMC17C2SJ | 147 | DBMMN21V1PN | 162 | DBMMZ17C2PN | 150 | DBMP21C1PVK87 | 50 |
| DBMMC17H2PJ | 154 | DBMMN21V1SN | 163 | DBMMZ17C2SN | 151 | DBMP21C1SJA197 | 45 |
| DBMMC17H2SJ | 155 | DBMMN5C5PN | 150 | DBMMZ17H2PN | 158 | DBMP21C1SVA197 | 51 |
| DBMMC21C1PJ | 146 | DBMMN5C5SN | 151 | DBMMZ17H2SN | 159 | DBMP21H1PJK87 | 60 |
| DBMMC21C1SJ | 147 | DBMMN5H5PN | 158 | DBMMZ17V2PN | 162 | DBMP21H1SJA197 | 61 |
| DBMMC21H1PJ | 154 | DBMMN5H5SN | 159 | DBMMZ17V2SN | 163 | DBMP21P1PVK87 | 64 |
| DBMMC21H1SJ | 155 | DBMMN5V5PN | 162 | DBMMZ21C1PN | 150 | DBMP21P1SVA197 | 65 |
| DBMMC5C5PJ | 146 | DBMMN5V5SN | 163 | DBMMZ21C1SN | 151 | DBMP25PJK87 | 16 |
| DBMMC5C5SJ | 147 | DBMMN9C4PN | 150 | DBMMZ21H1PN | 158 | DBMP25SJA197 | 17 |
| DBMMC5H5PJ | 154 | DBMMN9C4SN | 151 | DBMMZ21H1SN | 159 | DBMP5C5PJK87 | 44 |
| DBMMC5H5SJ | 155 | DBMMN9H4PN | 158 | DBMMZ21V1PN | 162 | DBMP5C5PVK87 | 50 |
| DBMMC9C4PJ | 146 | DBMMN9H4SN | 159 | DBMMZ21V1SN | 163 | DBMP5C5SJA197 | 45 |
| DBMMC9C4SJ | 147 | DBMMN9V4PN | 162 | DBMMZ5C5PN | 150 | DBMP5C5SVA197 | 51 |
| DBMMC9H4PJ | 154 | DBMMN9V4SN | 163 | DBMMZ5C5SN | 151 | DBMP5H5PJK87 | 60 |
| DBMMC9H4SJ | 155 | DBMMMP13C3PJ | 146 | DBMMZ5H5PN | 158 | DBMP5H5SJA197 | 61 |
| DBMMD13C3PJ | 146 | DBMMP13C3SJ | 147 | DBMMZ5H5SN | 159 | DBMP5P5PVK87 | 64 |
| DBMMD13C3SJ | 147 | DBMMP13H3PJ | 154 | DBMMZ5V5PN | 162 | DBMP5P5SVA197 | 65 |
| DBMMD13H3PJ | 154 | DBMMP13H3SJ | 155 | DBMMZ5V5SN | 163 | DBMP5W5PK87 | 78 |
| DBMMD13H3SJ | 155 | DBMMP17C2PJ | 146 | DBMMZ9C4PN | 150 | DBMP5W5PNM | 188 |
| DBMMD17C2PJ | 146 | DBMMP17C2SJ | 147 | DBMMZ9C4SN | 151 | DBMP9C4PJK87 | 44 |
| DBMMD17C2SJ | 147 | DBMMP17H2PJ | 154 | DBMMZ9H4PN | 158 | DBMP9C4PVK87 | 50 |
| DBMMD17H2PJ | 154 | DBMMP17H2SJ | 155 | DBMMZ9H4SN | 159 | DBMP9C4SJA197 | 45 |
| DBMMD17H2SJ | 155 | DBMMP21C1PJ | 146 | DBMMZ9V4PN | 162 | DBMP9C4SVA197 | 51 |
| DBMMD21C1PJ | 146 | DBMMP21C1SJ | 147 | DBMMZ9V4SN | 163 | DBMP9H4PJK87 | 60 |
| DBMMD21C1SJ | 147 | DBMMP21H1PJ | 154 | DBMN13C3PNK87 | 52 | DBMP9H4SJA197 | 61 |
| DBMMD21H1PJ | 154 | DBMMP21H1SJ | 155 | DBMN13C3PYK87 | 56 | DBMP9P4PVK87 | 64 |
| DBMMD21H1SJ | 155 | DBMMP5C5PJ | 146 | DBMN13C3SNA197 | 53 | DBMP9P4SVA197 | 65 |
| DBMMD5C5PJ | 146 | DBMMP5C5SJ | 147 | DBMN13C3SYA197 | 57 | DBMV13C3PNK87 | 52 |
| DBMMD5C5SJ | 147 | DBMMP5H5PJ | 154 | DBMN13H3PNK87 | 66 | DBMV13C3PYK87 | 56 |
| DBMMD5H5PJ | 154 | DBMMP5H5SJ | 155 | DBMN13H3PYK87 | 70 | DBMV13C3SNA197 | 53 |
| DBMMD5H5SJ | 155 | DBMMP5W5PJ | 166 | DBMN13H3SNA197 | 67 | DBMV13C3SYA197 | 57 |
| DBMMD9C4PJ | 146 | DBMMP9C4PJ | 146 | DBMN13H3SYA197 | 71 | DBMV13H3PNK87 | 66 |
| DBMMD9C4SJ | 147 | DBMMP9C4SJ | 147 | DBMN17C2PNK87 | 52 | DBMV13H3PYK87 | 70 |
| DBMMD9H4PJ | 154 | DBMMP9H4PJ | 154 | DBMN17C2PYK87 | 56 | DBMV13H3SNA197 | 67 |
| DBMMD9H4SJ | 155 | DBMMP9H4SJ | 155 | DBMN17C2SNA197 | 53 | DBMV13H3SYA197 | 71 |
| DBMME13W3PJ | 166 | DBMMV13C3PN | 150 | DBMN17C2SYA197 | 57 | DBMV17C2PNK87 | 52 |
| DBMME13W3SJ | 167 | DBMMV13C3SN | 151 | DBMN17H2PNK87 | 66 | DBMV17C2PYK87 | 56 |
| DBMME17W2PJ | 166 | DBMMV13H3PN | 158 | DBMN17H2PYK87 | 70 | DBMV17C2SNA197 | 53 |
| DBMME17W2SJ | 167 | DBMMV13H3SN | 159 | DBMN17H2SNA197 | 67 | DBMV17C2SYA197 | 57 |
| DBMME21W1PJ | 166 | DBMMV13V3PN | 162 | DBMN17H2SYA197 | 71 | DBMV17H2PNK87 | 66 |
| DBMME21W1SJ | 167 | DBMMV13V3SN | 163 | DBMN21C1PNK87 | 52 | DBMV17H2PYK87 | 70 |
| DBMME25PJ | 140 | DBMMV17C2PN | 150 | DBMN21C1PYK87 | 56 | DBMV17H2SNA197 | 67 |
| DBMME25SJ | 141 | DBMMV17C2SN | 151 | DBMN21C1SNA197 | 53 | DBMV17H2SYA197 | 71 |
| DBMME5W5PJ | 166 | DBMMV17H2PN | 158 | DBMN21C1SYA197 | 57 | DBMV21C1PNK87 | 52 |
| DBMME5W5SJ | 167 | DBMMV17H2SN | 159 | DBMN21H1PNK87 | 66 | DBMV21C1PYK87 | 56 |
| DBMME9W4PJ | 166 | DBMMV17V2PN | 162 | DBMN21H1PYK87 | 70 | DBMV21C1SNA197 | 53 |
| DBMME9W4SJ | 167 | DBMMV17V2SN | 163 | DBMN21H1SNA197 | 67 | DBMV21C1SYA197 | 57 |
| DBMMG13C3PJ | 146 | DBMMV21C1PN | 150 | DBMN21H1SYA197 | 71 | DBMV21H1PNK87 | 66 |
| DBMMG13C3SJ | 147 | DBMMV21C1SN | 151 | DBMN25PNK87 | 6 | DBMV21H1PYK87 | 70 |
| DBMMG13H3PJ | 154 | DBMMV21H1PN | 158 | DBMN25SNA197 | 7 | DBMV21H1SNA197 | 67 |
| DBMMG13H3SJ | 155 | DBMMV21H1SN | 159 | DBMN5C5PNK87 | 52 | DBMV21H1SYA197 | 71 |
| DBMMG17C2PJ | 146 | DBMMV21V1PN | 162 | DBMN5C5PYK87 | 56 | DBMV25PNK87 | 6 |
| DBMMG17C2SJ | 147 | DBMMV21V1SN | 163 | DBMN5C5SNA197 | 53 | DBMV25SNA197 | 7 |
| DBMMG17H2PJ | 154 | DBMMV5C5PN | 150 | DBMN5C5SYA197 | 57 | DBMV5C5PNK87 | 52 |
| DBMMG17H2SJ | 155 | DBMMV5C5SN | 151 | DBMN5H5PNK87 | 66 | DBMV5C5PYK87 | 56 |
| DBMMG21C1PJ | 146 | DBMMV5H5PN | 158 | DBMN5H5PYK87 | 70 | DBMV5C5SNA197 | 53 |
| DBMMG21C1SJ | 147 | DBMMV5H5SN | 159 | DBMN5H5SNA197 | 67 | DBMV5C5SYA197 | 57 |
| DBMMG21H1PJ | 154 | DBMMV5V5PN | 162 | DBMN5H5SYA197 | 71 | DBMV5H5PNK87 | 66 |
| DBMMG21H1SJ | 155 | DBMMV5V5SN | 163 | DBMN9C4PNK87 | 52 | DBMV5H5PYK87 | 70 |
| DBMMG5C5PJ | 146 | DBMMV9C4PN | 150 | DBMN9C4PYK87 | 56 | DBMV5H5SNA197 | 67 |
| DBMMG5C5SJ | 147 | DBMMV9C4SN | 151 | DBMN9C4SNA197 | 53 | DBMV5H5SYA197 | 71 |
| DBMMG5H5PJ | 154 | DBMMV9H4PN | 158 | DBMN9C4SYA197 | 57 | DBMV9C4PNK87 | 52 |
| DBMMG5H5SJ | 155 | DBMMV9H4SN | 159 | DBMN9H4PNK87 | 66 | DBMV9C4PYK87 | 56 |
| DBMMG9C4PJ | 146 | DBMMV9V4PN | 162 | DBMN9H4PYK87 | 70 | DBMV9C4SNA197 | 53 |
| DBMMG9C4SJ | 147 | DBMMV9V4SN | 163 | DBMN9H4SNA197 | 67 | DBMV9C4SYA197 | 57 |
| DBMMG9H4PJ | 154 | DBMMY13W3PJ | 166 | DBMN9H4SYA197 | 71 | DBMV9H4PNK87 | 66 |
| DBMMG9H4SJ | 155 | DBMMY13W3SJ | 167 | DBMP13C3PJK87 | 44 | DBMV9H4PYK87 | 70 |
| DBMMN13C3PN | 150 | DBMMY17W2PJ | 166 | DBMP13C3PVK87 | 50 | DBMV9H4SNA197 | 67 |
| DBMMN13C3SN | 151 | DBMMY17W2SJ | 167 | DBMP13C3SJA197 | 45 | DBMV9H4SYA197 | 71 |
| DBMMN13H3PN | 158 | DBMMY21W1PJ | 166 | DBMP13C3SVA197 | 51 | DBMY13W3PK87 | 78 |
| DBMMN13H3SN | 159 | DBMMY21W1SJ | 167 | DBMP13H3PJK87 | 60 | DBMY13W3PNM | 188 |
| DBMMN13V3PN | 162 | DBMMY25PJ | 140 | DBMP13H3SJA197 | 61 | DBMY13W3SA197 | 79 |
| DBMMN13V3SN | 163 | DBMMY25SJ | 141 | DBMP13P3PVK87 | 64 | DBMY13W3SNM | 189 |
| DBMMN17C2PN | 150 | DBMMY5W5PJ | 166 | DBMP13P3SVA197 | 65 | DBMY17W2PK87 | 78 |
| DBMMN17C2SN | 151 | DBMMY5W5SJ | 167 | DBMP17C2PJK87 | 44 | DBMY17W2PNM | 188 |
| DBMMN17H2PJ | 158 | DBMMY9W4PJ | 166 | DBMP17C2PVK87 | 50 | DBMY17W2SA197 | 79 |
| DBMMN17H2SN | 159 | DBMMY9W4SJ | 167 | DBMP17C2SJA197 | 45 | DBMY17W2SNA197 | 189 |
| DBMMN17V2PN | 162 | DBMMZ13C3PN | 150 | DBMP17C2SVA197 | 51 | DBMY21W1PK87 | 78 |
| DBMMN17V2SN | 163 | DBMMZ13C3SN | 151 | DBMP17H2PJK87 | 60 | DBMY21W1PNM | 188 |
| DBMMN21C1PN | 150 | DBMMZ13H3PN | 158 | DBMP17H2SJA197 | 61 | DBMY21W1SA197 | 79 |

| Part Number | Page | Part Number | Page | Part Number | Page | Part Number | Page |
|---------------------|----------|---------------------|----------|----------------------|------|----------------------|------|
| DBMY21W1SNM | 189 | DC111808-1 | 216 | DCJK37P*-1AWN | 116 | DCM-21WA4S-NMB-77 | 195 |
| DBMY25P | 140 | DC111808-5 | 216 | DCJK37P*-1U0N | 108 | DCM-21WA4S-OL2-A197 | 77 |
| DBMY25PNM | 180 | DC115339-23 | 205 | DCJK37P*-1U7N | 112 | DCM-21WA4S-OL4-A197 | 77 |
| DBMY25PNM*1A0N | 176 | DC115339-3 | 207 | DCJK37P*-1U7N-146 | 112 | DCM-25W36-NMB-77 | 195 |
| DBMY25POL3NM | 172 | DC115386-100A | 195 | DCJK37P*-OL4 | 120 | DCM-25W3P-1A0N-K87 | 74 |
| DBMY25S | 141 | DC115386-4B | 207 | DCJK37S*-1A0N | 111 | DCM-25W3P-1A7N-K87 | 74 |
| DBMY25SNM | 181 | DC121073-152 | 200 | DCJK37S*-1A5N | 119 | DCM-25W3P-NMB-77 | 195 |
| DBMY25SNM*1A0N | 177 | DC121073-52 | 200 | DCJK37S*-1A6N | 119 | DCM-25W3P-OL2-K87 | 76 |
| DBMY25SOL3NM | 173 | DC19678-138 | 193, 195 | DCJK37S*-1A7N | 115 | DCM-25W3P-OL4-K87 | 76 |
| DBMY5W5PK87 | 78 | DC19678-162 | 195 | DCJK37S*-1A8N | 115 | DCM-25W3S-1A0N-A197 | 75 |
| DBMY5W5PNM | 188 | DC19678-173 | 195 | DCJK37S*-1A9N | 115 | DCM-25W3S-1A7N-A197 | 75 |
| DBMY5W5SA197 | 79 | DC19678-3 | 204 | DCJK37S*-1ADN | 117 | DCM-25W3S-NMC-76 | 195 |
| DBMY5W5SNM | 189 | DC19977-3 | 204 | DCJK37S*-1AFN | 115 | DCM-25W3S-NMC-77 | 195 |
| DBMY9W4PK87 | 78 | DC19977-45 | 193, 195 | DCJK37S*-1AGN | 117 | DCM-25W3S-OL2-A197 | 77 |
| DBMY9W4PNM | 188 | DC20963 | 203 | DCJK37S*-1AHN | 115 | DCM-25W3S-OL4-A197 | 77 |
| DBMY9W4SA197 | 79 | DC20963-17 | 192 | DCJK37S*-1AJN | 117 | DCM-27W2P-1A0N-K87 | 74 |
| DBMY9W4SNM | 189 | DC22070 | 215 | DCJK37S*-1APN | 119 | DCM-27W2P-1A7N-K87 | 74 |
| DBMZ13C3PNK87 | 52 | DC22071 | 214 | DCJK37S*-1ATN | 119 | DCM-27W2P-OL2-K87 | 76 |
| DBMZ13C3PYK87 | 56 | DC24660 | 203 | DCJK37S*-1AUN | 119 | DCM-27W2P-OL4-K87 | 76 |
| DBMZ13C3SNA197 | 53 | DC24660-16 | 192, 195 | DCJK37S*-1AVN | 117 | DCM-27W2S-1A0N-A197 | 75 |
| DBMZ13C3SYA197 | 57 | DC37P-OL2-K87 | 10 | DCJK37S*-1AWN | 117 | DCM-27W2S-1A7N-A197 | 75 |
| DBMZ13H3PNK87 | 66 | DC37P-1A5N-K87 | 26 | DCJK37S*-1U0N | 109 | DCM-27W2S-NMC-76 | 195 |
| DBMZ13H3PYK87 | 70 | DC37P-1A6N-K87 | 26 | DCJK37S*-1U7N | 113 | DCM-27W2S-OL2-A197 | 77 |
| DBMZ13H3SNA197 | 67 | DC37P-1A7N-K87 | 22 | DCJK37S*-1U7N-146 | 113 | DCM-27W2S-OL4-A197 | 77 |
| DBMZ13H3SYA197 | 71 | DC37P-1A8N-K87 | 22 | DCJKE37P*-OL4 | 121 | DCM-37P-NMC-77 | 195 |
| DBMZ17C2PNK87 | 52 | DC37P-1A9N-K87 | 22 | DCJKE37P*-1A0N | 110 | DCM-37S-NMB-76 | 195 |
| DBMZ17C2PYK87 | 56 | DC37P-1ADN-K87 | 24 | DCJKE37P*-1U0N | 108 | DCM-37S-NMC-76 | 195 |
| DBMZ17C2SNA197 | 53 | DC37P-1AFN-K87 | 22 | DCJKE37P*-OL4 | 120 | DCM-37S-NMC-77 | 195 |
| DBMZ17C2SYA197 | 57 | DC37P-1AJN-K87 | 24 | DCJKE37P*-OL4-146 | 120 | DCM-8W8P-1A0N-K87 | 74 |
| DBMZ17H2PNK87 | 66 | DC37P-1A0N-K87 | 20 | DCJKE37S*-1A0N | 111 | DCM-8W8P-1A7N-K87 | 74 |
| DBMZ17H2PYK87 | 70 | DC37P-1ATN-K87 | 26 | DCJKE37S*-1U0N | 109 | DCM-8W8P-NMB-77 | 195 |
| DBMZ17H2SNA197 | 67 | DC37P-1AUN-K87 | 26 | DCJKE37S*-OL4 | 121 | DCM-8W8P-NMC-77 | 195 |
| DBMZ17H2SYA197 | 71 | DC37P-1AVN-K87 | 24 | DCJKE37S*-OL4-146 | 121 | DCM-8W8P-OL2-K87 | 76 |
| DBMZ21C1PNK87 | 52 | DC37P-1AWN-K87 | 24 | DCJKX37P*-1A0N | 110 | DCM-8W8P-OL4-K87 | 76 |
| DBMZ21C1PYK87 | 56 | DC37P-F179A-K87 | 12 | DCJKX37P*-OL4 | 120 | DCM-8W8S-1A0N-A197 | 75 |
| DBMZ21C1SNA197 | 53 | DC37PK87 | 32 | DCJKX37P*-OL4-146 | 120 | DCM-8W8S-1A7N-A197 | 75 |
| DBMZ21C1SYA197 | 57 | DC37S-OL2-A197 | 11 | DCJKX37S*-1A0N | 111 | DCM-8W8S-MNC-76 | 195 |
| DBMZ21H1PNK87 | 66 | DC37S-1A5N-A197 | 27 | DCJKX37S*-OL4 | 121 | DCM-8W8S-NMB-77 | 195 |
| DBMZ21H1PYK87 | 70 | DC37S-1A6N-A197 | 27 | DCJKX37S*-OL4-146 | 121 | DCM-8W8S-NMC-77 | 195 |
| DBMZ21H1SNA197 | 67 | DC37S-1A7N-A197 | 23 | DCJT37P | 122 | DCM-8W8S-OL2-A197 | 77 |
| DBMZ21H1SYA197 | 71 | DC37S-1A8N-A197 | 23 | DCJT37S* | 123 | DCM-8W8S-OL4-A197 | 77 |
| DBMZ25PNK87 | 6 | DC37S-1A9N-A197 | 23 | DCJTE37P | 122 | DCM13W6P1A0NNMBK52 | 195 |
| DBMZ25SNA197 | 7 | DC37S-1ADN-A197 | 25 | DCJTE37S* | 123 | DCM13W6P1A7NNMBK52 | 195 |
| DBMZ5C5PNK87 | 52 | DC37S-1AFN-A197 | 23 | DCJTX37P | 122 | DCM13W6P1A9NNMBK52 | 195 |
| DBMZ5C5PYK87 | 56 | DC37S-1AJN-A197 | 25 | DCJTX37S* | 123 | DCM13W6PF179ANMBK52 | 195 |
| DBMZ5C5SNA197 | 53 | DC37S-1A0N-A197 | 21 | DCM-13W6P-1A0N-K87 | 74 | DCM13W6PK87 | 78 |
| DBMZ5C5SYA197 | 57 | DC37S-1ATN-A197 | 27 | DCM-13W6P-1A7N-K87 | 74 | DCM13W6PNM | 188 |
| DBMZ5H5PNK87 | 66 | DC37S-1AUN-A197 | 27 | DCM-13W6P-NMB-76 | 195 | DCM13W6PNMBK52 | 195 |
| DBMZ5H5PYK87 | 70 | DC37S-1AVN-A197 | 25 | DCM-13W6P-NMB-77 | 195 | DCM13W6POL3NNMBK52 | 195 |
| DBMZ5H5SNA197 | 67 | DC37S-1AWN-A197 | 25 | DCM-13W6P-NMC-76 | 195 | DCM13W6S1A0NNMBK52 | 195 |
| DBMZ5H5SYA197 | 71 | DC37S-F179A-A197 | 13 | DCM-13W6P-NMC-77 | 195 | DCM13W6S1A7NNMBK52 | 195 |
| DBMZ9C4PNK87 | 52 | DC37SA197 | 33 | DCM-13W6P-OL2-K87 | 76 | DCM13W6S1A9NNMBK52 | 195 |
| DBMZ9C4PYK87 | 56 | DC50907-1 | 218 | DCM-13W6P-OL4-K87 | 76 | DCM13W6SA197 | 79 |
| DBMZ9C4SNA197 | 53 | DC51214 | 206 | DCM-13W6S-1A0N-A197 | 75 | DCM13W6SF179ANMBK52 | 195 |
| DBMZ9C4SYA197 | 57 | DC51215 | 206 | DCM-13W6S-1A7N-A197 | 75 | DCM13W6SNM | 189 |
| DBMZ9H4PNK87 | 66 | DC51222-1 | 210 | DCM-13W6S-NMB-77 | 195 | DCM13W6SNMBK52 | 195 |
| DBMZ9H4PYK87 | 70 | DC53750-3 | 218 | DCM-13W6S-NMC-77 | 195 | DCM13W6SNMC76 | 195 |
| DBMZ9H4SNA197 | 67 | DCA21WA4PK87FO | 80 | DCM-13W6S-OL2-A197 | 77 | DCM13W6SOL3NNMBK52 | 195 |
| DBMZ9H4SYA197 | 71 | DCA21WA4SA197FO | 81 | DCM-13W6S-OL4-A197 | 77 | DCM17W5P1A0NNMBK52 | 195 |
| DBNG25P-P1 | 4 | DCA25W3PK87FO | 80 | DCM-17W5P-1A0N-K87 | 74 | DCM17W5P1A7NNMBK52 | 195 |
| DBNG25S-P1 | 5 | DCA37PK87FO | 36 | DCM-17W5P-1A7N-K87 | 74 | DCM17W5P1A9NNMBK52 | 195 |
| DBNGE25P-P1 | 4 | DCA37SA197FO | 37 | DCM-17W5P-NMB-76 | 195 | DCM17W5PF179ANMBK52 | 195 |
| DBNGE25S-P1 | 5 | DCA8W8PK87FO | 80 | DCM-17W5P-NMC-76 | 195 | DCM17W5PK87 | 78 |
| DBNGL25P-P1 | 4 | DCA8W8SA197FO | 81 | DCM-17W5P-NMC-77 | 195 | DCM17W5PNM | 188 |
| DBNGL25S-P1 | 5 | DCE37P-OL2-K87-146 | 10 | DCM-17W5P-OL2-K87 | 76 | DCM17W5PNMB77 | 195 |
| DBNGX25P-P1 | 4 | DCE37PK87 | 32 | DCM-17W5P-OL4-K87 | 76 | DCM17W5PNMBK52 | 195 |
| DBNGX25S-P1 | 5 | DCE37S-OL2-A197-146 | 11 | DCM-17W5S-1A0N-A197 | 75 | DCM17W5POL3NNMBK52 | 195 |
| DBNGZ25P-P1 | 4 | DCE37SA197 | 33 | DCM-17W5S-1A7N-A197 | 75 | DCM17W5S-NMB-76 | 195 |
| DBNGZ25S-P1 | 5 | DCJK37P*-1A0N | 110 | DCM-17W5S-NMB-77 | 195 | DCM17W5S1A0NNMBK52 | 195 |
| DBW25P* | 38 | DCJK37P*-1A5N | 118 | DCM-17W5S-NMC-76 | 195 | DCM17W5S1A7NNMBK52 | 195 |
| DBW25P*G | 38 | DCJK37P*-1A6N | 118 | DCM-17W5S-NMC-77 | 195 | DCM17W5S1A9NNMBK52 | 195 |
| DBW25S* | 39 | DCJK37P*-1A7N | 114 | DCM-17W5S-OL2-A197 | 77 | DCM17W5SA197 | 79 |
| DBW25S*G | 39 | DCJK37P*-1A8N | 114 | DCM-17W5S-OL4-A197 | 77 | DCM17W5SF179ANMBK52 | 195 |
| DBWE25P* | 38 | DCJK37P*-1A9N | 114 | DCM-21W4P-NMB-77 | 195 | DCM17W5SNM | 189 |
| DBWE25P*G | 38 | DCJK37P*-1ADN | 116 | DCM-21W4S-NMB-77 | 195 | DCM17W5SNMBK52 | 195 |
| DBWE25S* | 39 | DCJK37P*-1AFN | 114 | DCM-21WA4P-1A0N-K87 | 74 | DCM17W5SOL3NNMBK52 | 195 |
| DBWE25S*G | 39 | DCJK37P*-1AGN | 116 | DCM-21WA4P-1A7N-K87 | 74 | DCM21W4S-NMC-76 | 195 |
| DBX25P-OL2-K87-146 | 10 | DCJK37P*-1AHN | 114 | DCM-21WA4P-NMB-76 | 195 | DCM21WA4P-NMB-76 | 195 |
| DBX25PK87 | 32 | DCJK37P*-1AJN | 116 | DCM-21WA4P-NMC-76 | 195 | DCM21WA4P1A0NNMBK52 | 195 |
| DBX25S-OL2-A197-146 | 11 | DCJK37P*-1APN | 118 | DCM-21WA4P-OL2-K87 | 76 | DCM21WA4P1A7NNMBK52 | 195 |
| DBX25SA197 | 33 | DCJK37P*-1ATN | 118 | DCM-21WA4P-OL4-K87 | 76 | DCM21WA4P1A9NNMBK52 | 195 |
| DC-59-20 | 195, 218 | DCJK37P*-1AUN | 118 | DCM-21WA4S-1A0N-A197 | 75 | DCM21WA4PF179ANMBK52 | 195 |
| DC-60-20 | 195, 218 | DCJK37P*-1AVN | 116 | DCM-21WA4S-1A7N-A197 | 75 | DCM21WA4PK87 | 78 |

Reader's Resource

| Part Number | Page | Part Number | Page | Part Number | Page | Part Number | Page |
|----------------------|------|-------------------|------|-----------------|------|-----------------|------|
| DCM21WA4PNM | 188 | DCM37S1A7NNMBK52 | 195 | DCMC25C3SVA197 | 51 | DCME37P | 140 |
| DCM21WA4PNMBK52 | 195 | DCM37S1A9NNMBK52 | 195 | DCMC25H3PJK87 | 60 | DCME37S | 141 |
| DCM21WA4POL3NMBK52 | 195 | DCM37SA | 133 | DCMC25H3SJA197 | 61 | DCME8W8PK87 | 78 |
| DCM21WA4S-NMB-76 | 195 | DCM37SB | 137 | DCMC25P3PVK87 | 64 | DCME8W8SA197 | 79 |
| DCM21WA4S1A0NNMBK52 | 195 | DCM37SC | 135 | DCMC25P3SVA197 | 65 | DCMG13C6PJK87 | 44 |
| DCM21WA4S1A7NNMBK52 | 195 | DCM37SD | 133 | DCMC27C2PJK87 | 44 | DCMG13C6PVK87 | 50 |
| DCM21WA4S1A9NNMBK52 | 195 | DCM37SE | 137 | DCMC27C2PVK87 | 50 | DCMG13C6SJA197 | 45 |
| DCM21WA4SA197 | 79 | DCM37SF | 135 | DCMC27C2SJA197 | 45 | DCMG13C6SVA197 | 51 |
| DCM21WA4SF179ANMBK52 | 195 | DCM37SF179 | 139 | DCMC27C2SVA197 | 51 | DCMG13H6PJK87 | 60 |
| DCM21WA4SNM | 189 | DCM37SF179A | 139 | DCMC27H2PJK87 | 60 | DCMG13H6SJA197 | 61 |
| DCM21WA4SNMBK52 | 195 | DCM37SF179ANMBK52 | 195 | DCMC27H2SJA197 | 61 | DCMG13P6PVK87 | 64 |
| DCM21WA4SOL3NMBK52 | 195 | DCM37SG | 133 | DCMC27P2PVK87 | 64 | DCMG13P6SVA197 | 65 |
| DCM25W3P-NMB-76 | 195 | DCM37SH | 137 | DCMC27P2SVA197 | 65 | DCMG17C5PJK87 | 44 |
| DCM25W3P1A0NNMBK52 | 195 | DCM37SK | 135 | DCMC37PJK87 | 16 | DCMG17C5PVK87 | 50 |
| DCM25W3P1A7NNMBK52 | 195 | DCM37SL | 133 | DCMC37SJA197 | 17 | DCMG17C5SJA197 | 45 |
| DCM25W3P1A9NNMBK52 | 195 | DCM37SLNM | 175 | DCMC8C8PJK87 | 44 | DCMG17C5SVA197 | 51 |
| DCM25W3PF179ANMBK52 | 195 | DCM37SM | 137 | DCMC8C8PVK87 | 50 | DCMG17H5PJK87 | 60 |
| DCM25W3PK87 | 78 | DCM37SNM | 181 | DCMC8C8SJA197 | 45 | DCMG17H5SJA197 | 61 |
| DCM25W3PNM | 188 | DCM37SNM*1A7N | 179 | DCMC8C8SVA197 | 51 | DCMG17P5PVK87 | 64 |
| DCM25W3PNMBK52 | 195 | DCM37SNM*1A9N | 179 | DCMC8H8PJK87 | 60 | DCMG17P5SVA197 | 65 |
| DCM25W3POL3NMBK52 | 195 | DCM37SNM*1A0N | 177 | DCMC8H8SJA197 | 61 | DCMG21CA4PJK87 | 44 |
| DCM25W3S1A0NNMBK52 | 195 | DCM37SNMB77 | 195 | DCMC8P8PVK87 | 64 | DCMG21CA4PVK87 | 50 |
| DCM25W3S1A7NNMBK52 | 195 | DCM37SNMBK52 | 195 | DCMC8P8SVA197 | 65 | DCMG21CA4SJA197 | 45 |
| DCM25W3S1A9NNMBK52 | 195 | DCM37SOL3NM | 173 | DCMD13C6PJK87 | 44 | DCMG21CA4SVA197 | 51 |
| DCM25W3SA197 | 79 | DCM37SOL3NMBK52 | 195 | DCMD13C6PVK87 | 50 | DCMG21HA4PJK87 | 60 |
| DCM25W3SF179ANMBK52 | 195 | DCM37SP | 135 | DCMD13C6SJA197 | 45 | DCMG21HA4SJA197 | 61 |
| DCM25W3SNM | 189 | DCM37SR | 135 | DCMD13C6SVA197 | 51 | DCMG21PA4PVK87 | 64 |
| DCM25W3SNMBK52 | 195 | DCM37SS | 133 | DCMD13H6PJK87 | 60 | DCMG21PA4SVA197 | 65 |
| DCM25W3SOL3NMBK52 | 195 | DCM37SW | 133 | DCMD13H6SJA197 | 61 | DCMG25C3PJK87 | 44 |
| DCM27W2OL3NMBK52 | 195 | DCM37SX | 137 | DCMD13P6PVK87 | 64 | DCMG25C3PVK87 | 50 |
| DCM27W2P-NMC-76 | 195 | DCM37SZ | 137 | DCMD13P6SVA197 | 65 | DCMG25C3SJA197 | 45 |
| DCM27W2P1A0NNMBK52 | 195 | DCM50PC | 134 | DCMD17C5PJK87 | 44 | DCMG25C3SVA197 | 51 |
| DCM27W2P1A7NNMBK52 | 195 | DCM8W8PK87 | 78 | DCMD17C5PVK87 | 50 | DCMG25H3PJK87 | 60 |
| DCM27W2P1A9NNMBK52 | 195 | DCM8W8PNM | 188 | DCMD17C5SJA197 | 45 | DCMG25H3SJA197 | 61 |
| DCM27W2PF179ANMBK52 | 195 | DCM8W8PNMB76 | 195 | DCMD17C5SVA197 | 51 | DCMG25P3PVK87 | 64 |
| DCM27W2PK87 | 78 | DCM8W8PNMBK52 | 195 | DCMD17H5PJK87 | 60 | DCMG25P3SVA197 | 65 |
| DCM27W2PNM | 188 | DCM8W8PNMC76 | 195 | DCMD17H5SJA197 | 61 | DCMG27C2PJK87 | 44 |
| DCM27W2PNMBK52 | 195 | DCM8W8SA197 | 79 | DCMD17P5PVK87 | 64 | DCMG27C2PVK87 | 50 |
| DCM27W2POL3NMBK52 | 195 | DCM8W8SNM | 189 | DCMD17P5SVA197 | 65 | DCMG27C2SJA197 | 45 |
| DCM27W2S1A0NNMBK52 | 195 | DCM8W8SNMB76 | 195 | DCMD21CA4PJK87 | 44 | DCMG27C2SVA197 | 51 |
| DCM27W2S1A7NNMBK52 | 195 | DCM8W8SNMBK52 | 195 | DCMD21CA4PVK87 | 50 | DCMG27H2PJK87 | 60 |
| DCM27W2S1A9NNMBK52 | 195 | DCMA37PNM | 182 | DCMD21CA4SJA197 | 45 | DCMG27H2SJA197 | 61 |
| DCM27W2SA197 | 79 | DCMA37PNMBK52 | 195 | DCMD21CA4SVA197 | 51 | DCMG27P2PVK87 | 64 |
| DCM27W2SF179ANMBK52 | 195 | DCMA37SNM | 183 | DCMD21HA4PJK87 | 60 | DCMG27P2SVA197 | 65 |
| DCM27W2SNM | 189 | DCMA37SNMBK52 | 195 | DCMD21HA4SJA197 | 61 | DCMG37PJK87 | 16 |
| DCM27W2SNMBK52 | 195 | DCMA62PNM | 184 | DCMD21PA4PVK87 | 64 | DCMG37SJA197 | 17 |
| DCM37P | 140 | DCMA62SNM | 185 | DCMD21PA4SVA197 | 65 | DCMG8C8PJK87 | 44 |
| DCM37P1A0NNMBK52 | 195 | DCMAY37PNM | 182 | DCMD25C3PJK87 | 44 | DCMG8C8PVK87 | 50 |
| DCM37P1A7NNMBK52 | 195 | DCMAY37SNM | 183 | DCMD25C3PVK87 | 50 | DCMG8C8SJA197 | 45 |
| DCM37P1A9NNMBK52 | 195 | DCMAY62PNM | 184 | DCMD25C3SJA197 | 45 | DCMG8C8SVA197 | 51 |
| DCM37PA | 132 | DCMAY62SNM | 185 | DCMD25C3SVA197 | 51 | DCMG8H8PJK87 | 60 |
| DCM37PB | 136 | DCMB-17W5S-NMB-76 | 195 | DCMD25H3PJK87 | 60 | DCMG8H8SJA197 | 61 |
| DCM37PC | 134 | DCMB-37S-NMB-77 | 195 | DCMD25H3SJA197 | 61 | DCMG8P8PVK87 | 64 |
| DCM37PD | 132 | DCMB-37S-NMC-77 | 195 | DCMD25P3PVK87 | 64 | DCMG8P8SVA197 | 65 |
| DCM37PE | 136 | DCMB37S-NMB-76 | 195 | DCMD25P3SVA197 | 65 | DCMM13W6P | 166 |
| DCM37PF | 134 | DCMB37S-NMC-76 | 195 | DCMD27C2PJK87 | 44 | DCMM13W6S | 167 |
| DCM37PF179 | 138 | DCMC13C6PJK87 | 44 | DCMD27C2PVK87 | 50 | DCMM17W5P | 166 |
| DCM37PF179A | 138 | DCMC13C6PVK87 | 50 | DCMD27C2SJA197 | 45 | DCMM17W5S | 167 |
| DCM37PF179ANMBK52 | 195 | DCMC13C6SJA197 | 45 | DCMD27C2SVA197 | 51 | DCMM21WA4P | 166 |
| DCM37PG | 132 | DCMC13C6SVA197 | 51 | DCMD27H2PJK87 | 60 | DCMM21WA4S | 167 |
| DCM37PH | 136 | DCMC13H6PJK87 | 60 | DCMD27H2SJA197 | 61 | DCMM24W7S | 167 |
| DCM37PK | 134 | DCMC13H6SJA197 | 61 | DCMD27P2PVK87 | 64 | DCMM25W3P | 166 |
| DCM37PL | 132 | DCMC13P6PVK87 | 64 | DCMD27P2SVA197 | 65 | DCMM25W3S | 167 |
| DCM37PLNM | 174 | DCMC13P6SVA197 | 65 | DCMD37PJK87 | 16 | DCMM27W2P | 166 |
| DCM37PM | 136 | DCMC17C5PJK87 | 44 | DCMD37SJA197 | 17 | DCMM27W2S | 167 |
| DCM37PNM | 180 | DCMC17C5PVK87 | 50 | DCMD8C8PJK87 | 44 | DCMM36W4S | 167 |
| DCM37PNM*1A7N | 178 | DCMC17C5SJA197 | 45 | DCMD8C8PVK87 | 50 | DCMM37P | 140 |
| DCM37PNM*1A9N | 178 | DCMC17C5SVA197 | 51 | DCMD8C8SJA197 | 45 | DCMM37PA | 132 |
| DCM37PNM*1A0N | 176 | DCMC17H5PJK87 | 60 | DCMD8C8SVA197 | 51 | DCMM37PB | 136 |
| DCM37PNMB76 | 195 | DCMC17H5SJA197 | 61 | DCMD8H8PJK87 | 60 | DCMM37PC | 134 |
| DCM37PNMB77 | 195 | DCMC17P5PVK87 | 64 | DCMD8H8SJA197 | 61 | DCMM37PD | 132 |
| DCM37PNMBK52 | 195 | DCMC17P5SVA197 | 65 | DCMD8P8PVK87 | 64 | DCMM37PE | 136 |
| DCM37PNMC76 | 195 | DCMC21CA4PJK87 | 44 | DCMD8P8SVA197 | 65 | DCMM37PF | 134 |
| DCM37POL3NM | 172 | DCMC21CA4PVK87 | 50 | DCME13W6PK87 | 78 | DCMM37PF179 | 138 |
| DCM37POL3NMBK52 | 195 | DCMC21CA4SJA197 | 45 | DCME13W6SA197 | 79 | DCMM37PF179A | 138 |
| DCM37PPP | 134 | DCMC21CA4SVA197 | 51 | DCME17W5PK87 | 78 | DCMM37PG | 132 |
| DCM37PR | 134 | DCMC21HA4PJK87 | 60 | DCME17W5SJA197 | 79 | DCMM37PH | 136 |
| DCM37PS | 132 | DCMC21HA4SJA197 | 61 | DCME21WA4PK87 | 78 | DCMM37PK | 134 |
| DCM37PW | 132 | DCMC21PA4PVK87 | 64 | DCME21WA4SA197 | 79 | DCMM37PL | 132 |
| DCM37PX | 136 | DCMC21PA4SVA197 | 65 | DCME25W3PK87 | 78 | DCMM37PM | 136 |
| DCM37PZ | 136 | DCMC25C3PJK87 | 44 | DCME25W3SA197 | 79 | DCMM37PP | 134 |
| DCM37S | 141 | DCMC25C3PVK87 | 50 | DCME27W2PK87 | 78 | DCMM37PR | 134 |
| DCM37S1A0NNMBK52 | 195 | DCMC25C3SJA197 | 45 | DCME27W2SA197 | 79 | DCMM37PS | 132 |

D Subminiature

Part Number Index

| Part Number | Page | Part Number | Page | Part Number | Page | Part Number | Page |
|--------------|------|--------------|------|--------------|------|-----------------|------|
| DCMM37PW | 132 | DCMME25W3S | 167 | DCMMP25C3SJ | 147 | DCMMZ25C3PN | 150 |
| DCMM37PX | 136 | DCMME27W2P | 166 | DCMMP25H3PJ | 154 | DCMMZ25C3SN | 151 |
| DCMM37PZ | 136 | DCMME27W2S | 167 | DCMMP25H3SJ | 155 | DCMMZ25H3PN | 158 |
| DCMM37S | 141 | DCMME36W4S | 167 | DCMMP27C2PJ | 146 | DCMMZ25H3SN | 159 |
| DCMM37SA | 133 | DCMME37P | 140 | DCMMP27C2SJ | 147 | DCMMZ25V3PN | 162 |
| DCMM37SB | 137 | DCMME37S | 141 | DCMMP27H2PJ | 154 | DCMMZ25V3SN | 163 |
| DCMM37SC | 135 | DCMME43W2S | 167 | DCMMP27H2SJ | 155 | DCMMZ27C2PN | 150 |
| DCMM37SD | 133 | DCMME47W1S | 167 | DCMMP8C8PJ | 146 | DCMMZ27C2SN | 151 |
| DCMM37SE | 137 | DCMME8W8P | 166 | DCMMP8C8SJ | 147 | DCMMZ27H2PN | 158 |
| DCMM37SF | 135 | DCMME8W8S | 167 | DCMMP8H8PJ | 154 | DCMMZ27H2SN | 159 |
| DCMM37SF179 | 139 | DCMMG13C6PJ | 146 | DCMMP8H8SJ | 155 | DCMMZ27V2PN | 162 |
| DCMM37SF179A | 139 | DCMMG13C6SJ | 147 | DCMMV13C6PN | 150 | DCMMZ27V2SN | 163 |
| DCMM37SG | 133 | DCMMG13H6PJ | 154 | DCMMV13C6SN | 151 | DCMMZ8C8PN | 150 |
| DCMM37SH | 137 | DCMMG13H6SJ | 155 | DCMMV13H6PN | 158 | DCMMZ8C8SN | 151 |
| DCMM37SK | 135 | DCMMG17C5PJ | 146 | DCMMV13H6SN | 159 | DCMMZ8H8PN | 158 |
| DCMM37SL | 133 | DCMMG17C5SJ | 147 | DCMMV13V6PN | 162 | DCMMZ8H8SN | 159 |
| DCMM37SM | 137 | DCMMG17H5PJ | 154 | DCMMV13V6SN | 163 | DCMMZ8V8PN | 162 |
| DCMM37SP | 135 | DCMMG17H5SJ | 155 | DCMMV17C5PN | 150 | DCMMZ8V8SN | 163 |
| DCMM37SR | 135 | DCMMG21CA4PJ | 146 | DCMMV17C5SN | 151 | DCMN13C6PNK87 | 52 |
| DCMM37SS | 133 | DCMMG21CA4SJ | 147 | DCMMV17H5PN | 158 | DCMN13C6PYK87 | 56 |
| DCMM37SW | 133 | DCMMG21HA4PJ | 154 | DCMMV17H5SN | 159 | DCMN13C6SNA197 | 53 |
| DCMM37SX | 137 | DCMMG21HA4SJ | 155 | DCMMV17V5PN | 162 | DCMN13C6SYA197 | 57 |
| DCMM37SZ | 137 | DCMMG25C3PJ | 146 | DCMMV17V5SN | 163 | DCMN13H6PNK87 | 66 |
| DCMM43W2S | 167 | DCMMG25C3SJ | 147 | DCMMV21CA4PN | 150 | DCMN13H6PYK87 | 70 |
| DCMM47W1S | 167 | DCMMG25H3PJ | 154 | DCMMV21CA4SN | 151 | DCMN13H6SNA197 | 67 |
| DCMM8W8P | 166 | DCMMG25H3SJ | 155 | DCMMV21HA4PN | 158 | DCMN13H6SYA197 | 71 |
| DCMM8W8S | 167 | DCMMG27C2PJ | 146 | DCMMV21HA4SN | 159 | DCMN17C5PNK87 | 52 |
| DCMMC13C6PJ | 146 | DCMMG27C2SJ | 147 | DCMMV21VA4PN | 162 | DCMN17C5PYK87 | 56 |
| DCMMC13C6SJ | 147 | DCMMG27H2PJ | 154 | DCMMV21VA4SN | 163 | DCMN17C5SNA197 | 53 |
| DCMMC13H6PJ | 154 | DCMMG27H2SJ | 155 | DCMMV25C3PN | 150 | DCMN17C5SYA197 | 57 |
| DCMMC13H6SJ | 155 | DCMMG8C8PJ | 146 | DCMMV25C3SN | 151 | DCMN17H5PNK87 | 66 |
| DCMMC17C5PJ | 146 | DCMMG8C8SJ | 147 | DCMMV25H3PN | 158 | DCMN17H5PYK87 | 70 |
| DCMMC17C5SJ | 147 | DCMMG8H8PJ | 154 | DCMMV25H3SN | 159 | DCMN17H5SNA197 | 67 |
| DCMMC17H5PJ | 154 | DCMMG8H8SJ | 155 | DCMMV25V3PN | 162 | DCMN17H5SYA197 | 71 |
| DCMMC17H5SJ | 155 | DCMMN13C6PN | 150 | DCMMV25V3SN | 163 | DCMN21CA4PNK87 | 52 |
| DCMMC21CA4PJ | 146 | DCMMN13C6SN | 151 | DCMMV27C2PN | 150 | DCMN21CA4PYK87 | 56 |
| DCMMC21CA4SJ | 147 | DCMMN13H6PN | 158 | DCMMV27C2SN | 151 | DCMN21CA4SNA197 | 53 |
| DCMMC21HA4PJ | 154 | DCMMN13H6SN | 159 | DCMMV27H2PN | 158 | DCMN21CA4SYA197 | 57 |
| DCMMC21HA4SJ | 155 | DCMMN13V6PN | 162 | DCMMV27H2SN | 159 | DCMN21HA4PNK87 | 66 |
| DCMMC25C3PJ | 146 | DCMMN13V6SN | 163 | DCMMV27V2PN | 162 | DCMN21HA4PYK87 | 70 |
| DCMMC25C3SJ | 147 | DCMMN17C5PN | 150 | DCMMV27V2SN | 163 | DCMN21HA4SNA197 | 67 |
| DCMMC25H3PJ | 154 | DCMMN17C5SN | 151 | DCMMV8C8PN | 150 | DCMN21HA4SYA197 | 71 |
| DCMMC25H3SJ | 155 | DCMMN17H5PN | 158 | DCMMV8C8SN | 151 | DCMN25C3PNK87 | 52 |
| DCMMC27C2PJ | 146 | DCMMN17H5SN | 159 | DCMMV8H8PN | 158 | DCMN25C3PYK87 | 56 |
| DCMMC27C2SJ | 147 | DCMMN17V5PN | 162 | DCMMV8H8SN | 159 | DCMN25C3SNA197 | 53 |
| DCMMC27H2PJ | 154 | DCMMN17V5SN | 163 | DCMMV8V8PN | 162 | DCMN25C3SYA197 | 57 |
| DCMMC27H2SJ | 155 | DCMMN21CA4PN | 150 | DCMMV8V8SN | 163 | DCMN25H3PNK87 | 66 |
| DCMMC8C8PJ | 146 | DCMMN21CA4SN | 151 | DCMMY13W6P | 166 | DCMN25H3PYK87 | 70 |
| DCMMC8C8SJ | 147 | DCMMN21HA4PN | 158 | DCMMY13W6S | 167 | DCMN25H3SNA197 | 67 |
| DCMMC8H8PJ | 154 | DCMMN21HA4SN | 159 | DCMMY17W5P | 166 | DCMN25H3SYA197 | 71 |
| DCMMC8H8SJ | 155 | DCMMN21VA4PN | 162 | DCMMY17W5S | 167 | DCMN27C2PNK87 | 52 |
| DCMMD13C6PJ | 146 | DCMMN21VA4SN | 163 | DCMMY21WA4P | 166 | DCMN27C2PYK87 | 56 |
| DCMMD13C6SJ | 147 | DCMMN25C3PN | 150 | DCMMY21WA4S | 167 | DCMN27C2SNA197 | 53 |
| DCMMD13H6PJ | 154 | DCMMN25C3SN | 151 | DCMMY24W7S | 167 | DCMN27C2SYA197 | 57 |
| DCMMD13H6SJ | 155 | DCMMN25H3PN | 158 | DCMMY25W3P | 166 | DCMN27H2PNK87 | 66 |
| DCMMD17C5PJ | 146 | DCMMN25H3SN | 159 | DCMMY25W3S | 167 | DCMN27H2PYK87 | 70 |
| DCMMD17C5SJ | 147 | DCMMN25V3PN | 162 | DCMMY27W2P | 166 | DCMN27H2SNA197 | 67 |
| DCMMD17H5PJ | 154 | DCMMN25V3SN | 163 | DCMMY27W2S | 167 | DCMN27H2SYA197 | 71 |
| DCMMD17H5SJ | 155 | DCMMN27C2PN | 150 | DCMMY36W4S | 167 | DCMN37PNK87 | 6 |
| DCMMD21CA4PJ | 146 | DCMMN27C2SN | 151 | DCMMY37P | 140 | DCMN37SNA197 | 7 |
| DCMMD21CA4SJ | 147 | DCMMN27H2PN | 158 | DCMMY37S | 141 | DCMN8C8PNK87 | 52 |
| DCMMD21HA4PJ | 154 | DCMMN27H2SN | 159 | DCMMY43W2S | 167 | DCMN8C8PYK87 | 56 |
| DCMMD21HA4SJ | 155 | DCMMN27V2PN | 162 | DCMMY47W1S | 167 | DCMN8C8SNA197 | 53 |
| DCMMD25C3PJ | 146 | DCMMN27V2SN | 163 | DCMMY8W8P | 166 | DCMN8C8SYA197 | 57 |
| DCMMD25C3SJ | 147 | DCMMN8C8PN | 150 | DCMMY8W8S | 167 | DCMN8H8PNK87 | 66 |
| DCMMD25H3PJ | 154 | DCMMN8C8SN | 151 | DCMMZ13C6PN | 150 | DCMN8H8PYK87 | 70 |
| DCMMD25H3SJ | 155 | DCMMN8H8PN | 158 | DCMMZ13C6SN | 151 | DCMN8H8SNA197 | 67 |
| DCMMD27C2PJ | 146 | DCMMN8H8SN | 159 | DCMMZ13H6PN | 158 | DCMN8H8SYA197 | 71 |
| DCMMD27C2SJ | 147 | DCMMN8V8PN | 162 | DCMMZ13H6SN | 159 | DCMP13C6PJK87 | 44 |
| DCMMD27H2PJ | 154 | DCMMN8V8SN | 163 | DCMMZ13V6PN | 162 | DCMP13C6PVK87 | 50 |
| DCMMD27H2SJ | 155 | DCMMP13C6PJ | 146 | DCMMZ13V6SN | 163 | DCMP13C6SJA197 | 45 |
| DCMMD8C8PJ | 146 | DCMMP13C6SJ | 147 | DCMMZ17C5PN | 150 | DCMP13C6SVA197 | 51 |
| DCMMD8C8SJ | 147 | DCMMP13H6PJ | 154 | DCMMZ17C5SN | 151 | DCMP13H6PJK87 | 60 |
| DCMMD8H8PJ | 154 | DCMMP13H6SJ | 155 | DCMMZ17H5PN | 158 | DCMP13H6SJA197 | 61 |
| DCMMD8H8SJ | 155 | DCMMP17C5PJ | 146 | DCMMZ17H5SN | 159 | DCMP13P6PVK87 | 64 |
| DCMME13W6P | 166 | DCMMP17C5SJ | 147 | DCMMZ17V5PN | 162 | DCMP13P6SVA197 | 65 |
| DCMME13W6S | 167 | DCMMP17H5PJ | 154 | DCMMZ17V5SN | 163 | DCMP17C5PJK87 | 44 |
| DCMME17W5P | 166 | DCMMP17H5SJ | 155 | DCMMZ21CA4PN | 150 | DCMP17C5PVK87 | 50 |
| DCMME17W5S | 167 | DCMMP21CA4PJ | 146 | DCMMZ21CA4SN | 151 | DCMP17C5SJA197 | 45 |
| DCMME21WA4P | 166 | DCMMP21CA4SJ | 147 | DCMMZ21HA4PN | 158 | DCMP17C5SVA197 | 51 |
| DCMME21WA4S | 167 | DCMMP21HA4PJ | 154 | DCMMZ21HA4SN | 159 | DCMP17H5PJK87 | 60 |
| DCMME24W7S | 167 | DCMMP21HA4SJ | 155 | DCMMZ21VA4PN | 162 | DCMP17H5SJA197 | 61 |
| DCMME25W3P | 166 | DCMMP25C3PJ | 146 | DCMMZ21VA4SN | 163 | DCMP17P5PVK87 | 64 |

| Part Number | Page | Part Number | Page | Part Number | Page | Part Number | Page |
|-----------------|------|-----------------|------|---------------------|----------|---------------------|------|
| DCMP17P5SVA197 | 65 | DCMV8H8SNA197 | 67 | DCMZ8H8SYA197 | 71 | DDE50P-OL2-K87-146 | 10 |
| DCMP21CA4PJK87 | 44 | DCMV8H8SYA197 | 71 | DCNG37P-P1 | 4 | DDE50PK87 | 32 |
| DCMP21CA4PVK87 | 50 | DCMY13W6PK87 | 78 | DCNG37S-P1 | 5 | DDE50S-OL2-A197-146 | 11 |
| DCMP21CA4SJA197 | 45 | DCMY13W6PNM | 188 | DCNGE37P-P1 | 4 | DDE50SA197 | 33 |
| DCMP21CA4SVA197 | 51 | DCMY13W6SA197 | 79 | DCNGE37S-P1 | 5 | DDJK50P*-OL4 | 120 |
| DCMP21HA4PJK87 | 60 | DCMY13W6SNM | 189 | DCNGL37P-P1 | 4 | DDJKE50P*-OL4 | 120 |
| DCMP21HA4SJA197 | 61 | DCMY17W5PK87 | 78 | DCNGL37S-P1 | 5 | DDJKE50P*-OL4-146 | 120 |
| DCMP21PA4PVK87 | 64 | DCMY17W5PNM | 188 | DCNGX37P-P1 | 4 | DDJKX50P*-OL4 | 120 |
| DCMP21PA4SVA197 | 65 | DCMY17W5SA197 | 79 | DCNGX37S-P1 | 5 | DDJKX50P*-OL4-146 | 120 |
| DCMP25C3PJK87 | 44 | DCMY17W5SNM | 189 | DCNGZ37P-P1 | 4 | DDM-24W7P-1A0N-K87 | 74 |
| DCMP25C3PVK87 | 50 | DCMY21WA4PK87 | 78 | DCNGZ37S-P1 | 5 | DDM-24W7P-1A7N-K87 | 74 |
| DCMP25C3SJA197 | 45 | DCMY21WA4PNM | 188 | DCW37P* | 38 | DDM-24W7P-NMB-77 | 195 |
| DCMP25C3SVA197 | 51 | DCMY21WA4SA197 | 79 | DCW37P*G | 38 | DDM-24W7P-NMC-76 | 195 |
| DCMP25H3PJK87 | 60 | DCMY21WA4SNM | 189 | DCW37S* | 39 | DDM-24W7P-OL2-K87 | 76 |
| DCMP25H3SJA197 | 61 | DCMY25W3PK87 | 78 | DCW37S*G | 39 | DDM-24W7P-OL4-K87 | 76 |
| DCMP25P3PVK87 | 64 | DCMY25W3PNM | 188 | DCWE37P* | 38 | DDM-24W7S-1A0N-A197 | 75 |
| DCMP25P3SVA197 | 65 | DCMY25W3SA197 | 79 | DCWE37P*G | 38 | DDM-24W7S-1A7N-A197 | 75 |
| DCMP27C2PJK87 | 44 | DCMY25W3SNM | 189 | DCWE37S* | 39 | DDM-24W7S-NMB-76 | 195 |
| DCMP27C2PVK87 | 50 | DCMY27W2PK87 | 78 | DCWE37S*G | 39 | DDM-24W7S-NMC-76 | 195 |
| DCMP27C2SJA197 | 45 | DCMY27W2PNM | 188 | DCX37P-OL2-K87-146 | 10 | DDM-24W7S-OL2-A197 | 77 |
| DCMP27C2SVA197 | 51 | DCMY27W2SA197 | 79 | DCX37PK87 | 32 | DDM-24W7S-OL4-A197 | 77 |
| DCMP27H2PJK87 | 60 | DCMY27W2SNM | 189 | DCX37S-OL2-A197-146 | 11 | DDM-36W4P-1A0N-K87 | 74 |
| DCMP27H2SJA197 | 61 | DCMY37P | 140 | DCX37SA197 | 33 | DDM-36W4P-1A7N-K87 | 74 |
| DCMP27P2PVK87 | 64 | DCMY37PNM | 180 | DD-59-20 | 195, 218 | DDM-36W4P-NMB-77 | 195 |
| DCMP27P2SVA197 | 65 | DCMY37PNM*1A0N | 176 | DD-60-20 | 195, 218 | DDM-36W4P-OL2-K87 | 76 |
| DCMP37PJK87 | 16 | DCMY37POL3NM | 172 | DD115339-24 | 205 | DDM-36W4P-OL4-K87 | 76 |
| DCMP37SJA197 | 17 | DCMY37S | 141 | DD115339-4 | 207 | DDM-36W4S-1A0N-A197 | 75 |
| DCMP8C8PJK87 | 44 | DCMY37SNM | 181 | DD115386-103A | 195 | DDM-36W4S-1A7N-A197 | 75 |
| DCMP8C8PVK87 | 50 | DCMY37SNM*1A0N | 177 | DD121073-153 | 200 | DDM-36W4S-NMB-77 | 195 |
| DCMP8C8SJA197 | 45 | DCMY37SOL3NM | 173 | DD121073-53 | 200 | DDM-36W4S-NMC-76 | 195 |
| DCMP8C8SVA197 | 51 | DCMY8W8PK87 | 78 | DD19678-161 | 193, 195 | DDM-36W4S-OL2-A197 | 77 |
| DCMP8H8PJK87 | 60 | DCMY8W8PNM | 188 | DD19678-172 | 195 | DDM-36W4S-OL4-A197 | 77 |
| DCMP8H8SJA197 | 61 | DCMY8W8SA197 | 79 | DD19678-176 | 195 | DDM-43W2P-1A0N-K87 | 74 |
| DCMP8P8PVK87 | 64 | DCMY8W8SNM | 189 | DD19678-4 | 204 | DDM-43W2P-1A7N-K87 | 74 |
| DCMP8P8SVA197 | 65 | DCMZ13C6PNK87 | 52 | DD19977-4 | 204 | DDM-43W2P-OL2-K87 | 76 |
| DCMV13C6PNK87 | 52 | DCMZ13C6PYK87 | 56 | DD19977-44 | 193, 195 | DDM-43W2P-OL4-K87 | 76 |
| DCMV13C6PYK87 | 56 | DCMZ13C6SNA197 | 53 | DD20964 | 203 | DDM-43W2S-1A0N-A197 | 75 |
| DCMV13C6SNA197 | 53 | DCMZ13C6SYA197 | 57 | DD20964-19 | 192 | DDM-43W2S-1A7N-A197 | 75 |
| DCMV13C6SYA197 | 57 | DCMZ13H6PNK87 | 66 | DD21961 | 214 | DDM-43W2S-NMB-77 | 195 |
| DCMV13H6PNK87 | 66 | DCMZ13H6PYK87 | 70 | DD21962 | 215 | DDM-43W2S-NMC-76 | 195 |
| DCMV13H6PYK87 | 70 | DCMZ13H6SNA197 | 67 | DD24661 | 203 | DDM-43W2S-OL2-A197 | 77 |
| DCMV13H6SNA197 | 70 | DCMZ13H6SYA197 | 71 | DD24661-13 | 192, 195 | DDM-43W2S-OL4-A197 | 77 |
| DCMV13H6SYA197 | 71 | DCMZ17C5PNK87 | 52 | DD50908-1 | 218 | DDM-47W1P-1A0N-K87 | 74 |
| DCMV17C5PNK87 | 52 | DCMZ17C5PYK87 | 56 | DD50P-OL2-K87 | 10 | DDM-47W1P-1A7N-K87 | 74 |
| DCMV17C5PYK87 | 56 | DCMZ17C5SNA197 | 56 | DD50P-1A5N-K87 | 26 | DDM-47W1P-OL2-K87 | 76 |
| DCMV17C5SNA197 | 53 | DCMZ17C5SYA197 | 57 | DD50P-1A6N-K87 | 26 | DDM-47W1P-OL4-K87 | 76 |
| DCMV17C5SYA197 | 57 | DCMZ17H5PNK87 | 66 | DD50P-1A7N-K87 | 22 | DDM-47W1S-1A0N-A197 | 75 |
| DCMV17H5PNK87 | 66 | DCMZ17H5PYK87 | 70 | DD50P-1A8N-K87 | 22 | DDM-47W1S-1A7N-A197 | 75 |
| DCMV17H5PYK87 | 70 | DCMZ17H5SNA197 | 67 | DD50P-1A9N-K87 | 22 | DDM-47W1S-NMC-76 | 195 |
| DCMV17H5SNA197 | 67 | DCMZ17H5SYA197 | 71 | DD50P-1ADN-K87 | 24 | DDM-47W1S-OL2-A197 | 77 |
| DCMV17H5SYA197 | 71 | DCMZ21CA4PNK87 | 52 | DD50P-1AFN-K87 | 22 | DDM-47W1S-OL4-A197 | 77 |
| DCMV21CA4PNK87 | 52 | DCMZ21CA4PYK87 | 56 | DD50P-1AJN-K87 | 24 | DDM-50P-NMC-77 | 195 |
| DCMV21CA4PYK87 | 56 | DCMZ21CA4SNA197 | 53 | DD50P-1A0N-K87 | 20 | DDM-50S-NMC-76 | 195 |
| DCMV21CA4SNA197 | 53 | DCMZ21CA4SYA197 | 57 | DD50P-1ATN-K87 | 26 | DDM-50S-NMC-77 | 195 |
| DCMV21CA4SYA197 | 57 | DCMZ21HA4PNK87 | 66 | DD50P-1AUN-K87 | 26 | DDM24W7P1A0NNMBK52 | 195 |
| DCMV21HA4PNK87 | 66 | DCMZ21HA4PYK87 | 70 | DD50P-1AVN-K87 | 24 | DDM24W7P1A7NMBK52 | 195 |
| DCMV21HA4PYK87 | 70 | DCMZ21HA4SNA197 | 67 | DD50P-1AWN-K87 | 24 | DDM24W7P1A9NNMBK52 | 195 |
| DCMV21HA4SNA197 | 67 | DCMZ21HA4SYA197 | 71 | DD50P-F179A-K87 | 12 | DDM24W7PF179ANMBK52 | 195 |
| DCMV21HA4SYA197 | 71 | DCMZ25C3PNK87 | 52 | DD50PK87 | 32 | DDM24W7PK87 | 78 |
| DCMV25C3PNK87 | 52 | DCMZ25C3PYK87 | 56 | DD50S-OL2-A197 | 11 | DDM24W7PNM | 188 |
| DCMV25C3PYK87 | 56 | DCMZ25C3SNA197 | 53 | DD50S-1A5N-A197 | 27 | DDM24W7PNMB76 | 195 |
| DCMV25C3SNA197 | 53 | DCMZ25C3SYA197 | 57 | DD50S-1A6N-A197 | 27 | DDM24W7PNMBK52 | 195 |
| DCMV25C3SYA197 | 57 | DCMZ25H3PNK87 | 66 | DD50S-1A7N-A197 | 23 | DDM24W7POL3NMBK52 | 195 |
| DCMV25H3PNK87 | 66 | DCMZ25H3PYK87 | 70 | DD50S-1A8N-A197 | 23 | DDM24W7S1A0NNMBK52 | 195 |
| DCMV25H3PYK87 | 70 | DCMZ25H3SNA197 | 67 | DD50S-1A9N-A197 | 23 | DDM24W7S1A7NMBK52 | 195 |
| DCMV25H3SNA197 | 67 | DCMZ25H3SYA197 | 71 | DD50S-1ADN-A197 | 25 | DDM24W7S1A9NNMBK52 | 195 |
| DCMV25H3SYA197 | 71 | DCMZ27C2PNK87 | 52 | DD50S-1AFN-A197 | 23 | DDM24W7SA197 | 79 |
| DCMV27C2PNK87 | 52 | DCMZ27C2PYK87 | 56 | DD50S-1AJN-A197 | 25 | DDM24W7SF179ANMBK52 | 195 |
| DCMV27C2PYK87 | 56 | DCMZ27C2SNA197 | 53 | DD50S-1A0N-A197 | 21 | DDM24W7SNM | 189 |
| DCMV27C2SNA197 | 53 | DCMZ27C2SYA197 | 57 | DD50S-1ATN-A197 | 27 | DDM24W7SNMB77 | 195 |
| DCMV27C2SYA197 | 57 | DCMZ27H2PNK87 | 66 | DD50S-1AUN-A197 | 27 | DDM24W7SNMBK52 | 195 |
| DCMV27H2PNK87 | 66 | DCMZ27H2PYK87 | 70 | DD50S-1AVN-A197 | 25 | DDM24W7SOL3NMBK52 | 195 |
| DCMV27H2PYK87 | 70 | DCMZ27H2SNA197 | 67 | DD50S-1AWN-A197 | 25 | DDM36W4P1A0NNMBK52 | 195 |
| DCMV27H2SNA197 | 67 | DCMZ27H2SYA197 | 71 | DD50S-F179A-A197 | 13 | DDM36W4P1A7NMBK52 | 195 |
| DCMV27H2SYA197 | 71 | DCMZ37PNK87 | 6 | DD50SA197 | 33 | DDM36W4P1A9NNMBK52 | 195 |
| DCMV37PNK87 | 6 | DCMZ37SNA197 | 7 | DD51216 | 206 | DDM36W4PF179ANMBK52 | 195 |
| DCMV37SNA197 | 7 | DCMZ8C8PNK87 | 52 | DD51217 | 206 | DDM36W4PK87 | 78 |
| DCMV8C8PNK87 | 52 | DCMZ8C8PYK87 | 56 | DD51223-1 | 210 | DDM36W4PNM | 188 |
| DCMV8C8PYK87 | 56 | DCMZ8C8SNA197 | 53 | DD53750-4 | 218 | DDM36W4PNMBK52 | 195 |
| DCMV8C8SNA197 | 53 | DCMZ8C8SYA197 | 57 | DDA24W7PK87F0 | 80 | DDM36W4POL3NMBK52 | 195 |
| DCMV8C8SYA197 | 57 | DCMZ8H8PNK87 | 66 | DDA24W7SA197F0 | 81 | DDM36W4S1A0NNMBK52 | 195 |
| DCMV8H8PNK87 | 66 | DCMZ8H8PYK87 | 70 | DDA36W4PK87F0 | 80 | DDM36W4S1A7NMBK52 | 195 |
| DCMV8H8PYK87 | 70 | DCMZ8H8SNA197 | 67 | DDA36W4SA197F0 | 81 | DDM36W4S1A9NNMBK52 | 195 |

D Subminiature

Part Number Index

| Part Number | Page | Part Number | Page | Part Number | Page | Part Number | Page |
|---------------------|------|-------------------|------|----------------|------|-------------|------|
| DDM36W4SA197 | 79 | DDM50SF | 135 | DDME47W1SA197 | 79 | DDMMD24H7PJ | 156 |
| DDM36W4SF179ANMBK52 | 195 | DDM50SF179 | 139 | DDME50P | 140 | DDMMD24H7SJ | 157 |
| DDM36W4SNM | 189 | DDM50SF179A | 139 | DDME50S | 141 | DDMMD36C4PJ | 148 |
| DDM36W4SNMB76 | 195 | DDM50SF179ANMBK52 | 195 | DDMG24C7PK87 | 47 | DDMMD36C4SJ | 149 |
| DDM36W4SNMBK52 | 195 | DDM50SG | 133 | DDMG24C7SJA197 | 46 | DDMMD36H4PJ | 156 |
| DDM36W4SOL3NMBK52 | 195 | DDM50SH | 137 | DDMG24H7PK87 | 62 | DDMMD36H4SJ | 157 |
| DDM43W2P-NMB-77 | 195 | DDM50SK | 135 | DDMG24H7SJA197 | 63 | DDMMD43C2PJ | 148 |
| DDM43W2P1A0NNMBK52 | 195 | DDM50SL | 133 | DDMG36C4PK87 | 46 | DDMMD43C2SJ | 149 |
| DDM43W2P1A7NNMBK52 | 195 | DDM50SLNM | 175 | DDMG36C4SJA197 | 47 | DDMMD43H2PJ | 156 |
| DDM43W2P1A9NNMBK52 | 195 | DDM50SM | 137 | DDMG36H4PK87 | 62 | DDMMD43H2SJ | 157 |
| DDM43W2P179ANMBK52 | 195 | DDM50SNM | 181 | DDMG36H4SJA197 | 63 | DDMMD47C1PJ | 148 |
| DDM43W2PK87 | 78 | DDM50SNM*1A7N | 179 | DDMG43C2PK87 | 46 | DDMMD47C1SJ | 149 |
| DDM43W2PNM | 188 | DDM50SNM*1A9N | 179 | DDMG43C2SJA197 | 47 | DDMMD47H1PJ | 156 |
| DDM43W2PNMBK52 | 195 | DDM50SNM*1AON | 177 | DDMG43H2PK87 | 62 | DDMMD47H1SJ | 157 |
| DDM43W2POL3NMBK52 | 195 | DDM50SNMB76 | 195 | DDMG43H2SJA197 | 63 | DDMME24W7P | 166 |
| DDM43W2S1A0NNMBK52 | 195 | DDM50SNMB77 | 195 | DDMG47C1PK87 | 46 | DDMME36W4P | 166 |
| DDM43W2S1A7NNMBK52 | 195 | DDM50SNMBK52 | 195 | DDMG47C1SJA197 | 47 | DDMMD47C1PJ | 166 |
| DDM43W2S1A9NNMBK52 | 195 | DDM50SOL3NM | 173 | DDMG47H1PK87 | 62 | DDMME47W1P | 166 |
| DDM43W2SA197 | 79 | DDM50SOL3NMBK52 | 195 | DDMG47H1SJA197 | 63 | DDMME50P | 140 |
| DDM43W2SF179ANMBK52 | 195 | DDM50SP | 135 | DDMG50PK87 | 16 | DDMME50S | 141 |
| DDM43W2SNM | 189 | DDM50SR | 135 | DDMG50SJA197 | 17 | DDMMG24C7PJ | 148 |
| DDM43W2SNMBK52 | 195 | DDM50SS | 133 | DDMM24W7P | 166 | DDMMG24C7SJ | 149 |
| DDM43W2SOL3NMBK52 | 195 | DDM50SW | 133 | DDMM36W4P | 166 | DDMMG24H7PJ | 156 |
| DDM47W1P-NMC-76 | 195 | DDM50SX | 137 | DDMM43W2P | 166 | DDMMG24H7SJ | 157 |
| DDM47W1P1A0NNMBK52 | 195 | DDM50SZ | 137 | DDMM47W1P | 166 | DDMMG36C4PJ | 148 |
| DDM47W1P1A7NNMBK52 | 195 | DDMA50PNM | 182 | DDMM50P | 140 | DDMMG36C4SJ | 149 |
| DDM47W1P1A9NNMBK52 | 195 | DDMA50PNMBK52 | 195 | DDMM50PA | 132 | DDMMG36H4PJ | 156 |
| DDM47W1P179ANMBK52 | 195 | DDMA50SNM | 183 | DDMM50PB | 136 | DDMMG36H4SJ | 157 |
| DDM47W1PK87 | 78 | DDMA50SNMBK52 | 195 | DDMM50PC | 134 | DDMMG43C2PJ | 148 |
| DDM47W1PNM | 188 | DDMA78PNM | 184 | DDMM50PD | 132 | DDMMG43C2SJ | 149 |
| DDM47W1PNMBK52 | 195 | DDMA78SNM | 185 | DDMM50PE | 136 | DDMMG43H2PJ | 156 |
| DDM47W1POL3NMBK52 | 195 | DDMAY50PNM | 182 | DDMM50PF | 134 | DDMMG43H2SJ | 157 |
| DDM47W1S1A0NNMBK52 | 195 | DDMAY50SNM | 183 | DDMM50PF179 | 138 | DDMMG47C1PJ | 148 |
| DDM47W1S1A7NNMBK52 | 195 | DDMAY78PNM | 184 | DDMM50PF179A | 138 | DDMMG47C1SJ | 149 |
| DDM47W1S1A9NNMBK52 | 195 | DDMAY78SNM | 185 | DDMM50PG | 132 | DDMMG47H1PJ | 156 |
| DDM47W1SA197 | 79 | DDMB-247S-NMB-76 | 195 | DDMM50PH | 136 | DDMMG47H1SJ | 157 |
| DDM47W1SF179ANMBK52 | 195 | DDMB-50S-NMB-77 | 195 | DDMM50PK | 134 | DDMMN24C7PN | 152 |
| DDM47W1SNM | 189 | DDMB-50S-NMC-77 | 195 | DDMM50PL | 132 | DDMMN24C7SN | 153 |
| DDM47W1SNMBK52 | 195 | DDMB50S-NMB-76 | 195 | DDMM50PM | 136 | DDMMN24H7PN | 160 |
| DDM47W1SOL3NMBK52 | 195 | DDMB50S-NMC-76 | 195 | DDMM50PP | 134 | DDMMN24H7SN | 161 |
| DDM50P | 140 | DDMC24C7PK87 | 46 | DDMM50PR | 134 | DDMMN24V7PN | 164 |
| DDM50P1A0NNMBK52 | 195 | DDMC24C7SJA197 | 47 | DDMM50PS | 132 | DDMMN24V7SN | 165 |
| DDM50P1A7NNMBK52 | 195 | DDMC24H7PK87 | 62 | DDMM50PW | 132 | DDMMN36C4PN | 152 |
| DDM50P1A9NNMBK52 | 195 | DDMC24H7SJA197 | 63 | DDMM50PX | 136 | DDMMN36C4SN | 153 |
| DDM50PA | 132 | DDMC36C4PK87 | 46 | DDMM50PZ | 136 | DDMMN36H4PN | 160 |
| DDM50PB | 136 | DDMC36C4SJA197 | 47 | DDMM50S | 141 | DDMMN36H4SN | 161 |
| DDM50PD | 132 | DDMC36H4PK87 | 62 | DDMM50SA | 133 | DDMMN36V4PN | 164 |
| DDM50PE | 136 | DDMC36H4SJA197 | 63 | DDMM50SB | 137 | DDMMN36V4SN | 165 |
| DDM50PF | 134 | DDMC43C2PK87 | 46 | DDMM50SC | 135 | DDMMN43C2PN | 152 |
| DDM50PF179 | 138 | DDMC43C2SJA197 | 47 | DDMM50SD | 133 | DDMMN43C2SN | 153 |
| DDM50PF179A | 138 | DDMC43H2PK87 | 62 | DDMM50SE | 137 | DDMMN43H2PN | 160 |
| DDM50PF179ANMBK52 | 195 | DDMC43H2SJA197 | 63 | DDMM50SF | 135 | DDMMN43H2SN | 161 |
| DDM50PG | 132 | DDMC47C1PK87 | 46 | DDMM50SF179 | 139 | DDMMN43V2PN | 164 |
| DDM50PH | 136 | DDMC47C1SJA197 | 47 | DDMM50SF179A | 139 | DDMMN43V2SN | 165 |
| DDM50PK | 134 | DDMC47H1PK87 | 62 | DDMM50SG | 133 | DDMMN47C1PN | 152 |
| DDM50PL | 132 | DDMC47H1SJA197 | 63 | DDMM50SH | 137 | DDMMN47C1SN | 153 |
| DDM50PLNM | 174 | DDMC50PK87 | 16 | DDMM50SK | 135 | DDMMN47H1PN | 160 |
| DDM50PM | 136 | DDMC50SJA197 | 17 | DDMM50SL | 133 | DDMMN47H1SN | 161 |
| DDM50PNM | 180 | DDMD24C7PK87 | 46 | DDMM50SM | 137 | DDMMN47V1PN | 164 |
| DDM50PNM*1A7N | 178 | DDMD24C7SJA197 | 47 | DDMM50SP | 135 | DDMMN47V1SN | 165 |
| DDM50PNM*1A9N | 178 | DDMD24H7PK87 | 62 | DDMM50SR | 135 | DDMMP24C7PJ | 148 |
| DDM50PNM*1AON | 176 | DDMD24H7SJA197 | 63 | DDMM50SS | 133 | DDMMP24C7SJ | 149 |
| DDM50PNMB76 | 195 | DDMD36C4PK87 | 46 | DDMM50SW | 133 | DDMMP24H7PJ | 156 |
| DDM50PNMB77 | 195 | DDMD36C4SJA197 | 47 | DDMM50SX | 137 | DDMMP24H7SJ | 157 |
| DDM50PNMBK52 | 195 | DDMD36H4PK87 | 62 | DDMM50SZ | 137 | DDMMP36C4PJ | 148 |
| DDM50PNMC76 | 195 | DDMD36H4SJA197 | 63 | DDMMC24C7PJ | 148 | DDMMP36C4SJ | 149 |
| DDM50POL3NM | 172 | DDMD43C2PK87 | 46 | DDMMC24C7SJ | 149 | DDMMP36H4PJ | 156 |
| DDM50POL3NMBK52 | 195 | DDMD43C2SJA197 | 47 | DDMMC24H7PJ | 156 | DDMMP36H4SJ | 157 |
| DDM50PP | 134 | DDMD43H2PK87 | 62 | DDMMC24H7SJ | 157 | DDMMP43C2PJ | 148 |
| DDM50PR | 134 | DDMD43H2SJA197 | 63 | DDMMC36C4PJ | 148 | DDMMP43C2SJ | 149 |
| DDM50PS | 132 | DDMD47C1PK87 | 46 | DDMMC36C4SJ | 149 | DDMMP43H2PJ | 156 |
| DDM50PW | 132 | DDMD47C1SJA197 | 47 | DDMMC36H4PJ | 156 | DDMMP43H2SJ | 157 |
| DDM50PX | 136 | DDMD47H1PK87 | 62 | DDMMC36H4SJ | 157 | DDMMP47C1PJ | 148 |
| DDM50PZ | 136 | DDMD47H1SJA197 | 63 | DDMMC43C2PJ | 148 | DDMMP47C1SJ | 149 |
| DDM50S | 141 | DDMD50PK87 | 16 | DDMMC43C2SJ | 149 | DDMMP47H1PJ | 156 |
| DDM50S1A0NNMBK52 | 195 | DDMD50SJA197 | 17 | DDMMC43H2PJ | 156 | DDMMP47H1SJ | 157 |
| DDM50S1A7NNMBK52 | 195 | DDME24W7PK87 | 78 | DDMMC43H2SJ | 157 | DDMMV24C7PN | 152 |
| DDM50S1A9NNMBK52 | 195 | DDME24W7SA197 | 79 | DDMMC47C1PJ | 148 | DDMMV24C7SN | 153 |
| DDM50SA | 133 | DDME36W4PK87 | 78 | DDMMC47C1SJ | 149 | DDMMV24H7PN | 160 |
| DDM50SB | 137 | DDME36W4SA197 | 79 | DDMMC47H1PJ | 156 | DDMMV24H7SN | 161 |
| DDM50SC | 135 | DDME43W2PK87 | 78 | DDMMC47H1SJ | 157 | DDMMV24V7PN | 164 |
| DDM50SD | 133 | DDME43W2SA197 | 79 | DDMMD24C7PJ | 148 | DDMMV24V7SN | 165 |
| DDM50SE | 137 | DDME47W1PK87 | 78 | DDMMD24C7SJ | 149 | DDMMV36C4PN | 152 |

Table with 4 columns: Part Number, Page, Part Number, Page. Lists various subminiature part numbers and their corresponding page numbers.

D Subminiature

Part Number Index

| Part Number | Page | Part Number | Page | Part Number | Page | Part Number | Page |
|--------------------|------|------------------|------|-------------|------|--------------------|----------|
| DEM-5W1P-NMB-76 | 195 | DEM9SNM | 181 | DEMM5W1P | 166 | DEMMZ5V1SN | 163 |
| DEM-5W1P-NMB-77 | 195 | DEM9SNM*1A7N | 179 | DEMM5W1S | 167 | DEMNSC1PNK87 | 52 |
| DEM-5W1P-NMC-76 | 195 | DEM9SNM*1A9N | 179 | DEMM9P | 140 | DEMNSC1PYK87 | 56 |
| DEM-5W1P-OL2-K87 | 76 | DEM9SNM*1AON | 177 | DEMM9PA | 132 | DEMNSC1SNA197 | 53 |
| DEM-5W1P-OL4-K87 | 76 | DEM9SNMB77 | 195 | DEMM9PB | 136 | DEMNSC1SYA197 | 57 |
| DEM-5W1S-1A0N-A197 | 75 | DEM9SNMBK52 | 195 | DEMM9PC | 134 | DEMNSHIPNK87 | 66 |
| DEM-5W1S-1A7N-A197 | 75 | DEM9SNMC76 | 195 | DEMM9PD | 132 | DEMNSHIPYK87 | 70 |
| DEM-5W1S-NMB-77 | 195 | DEM9SOL3NM | 173 | DEMM9PE | 136 | DEMNSH1SNA197 | 67 |
| DEM-5W1S-NMC-76 | 195 | DEM9SOL3NMBK52 | 195 | DEMM9PF | 134 | DEMNSH1SYA197 | 71 |
| DEM-5W1S-OL2-A197 | 77 | DEM9SP | 135 | DEMM9PF179 | 138 | DEMNP9NK87 | 6 |
| DEM-5W1S-OL4-A197 | 77 | DEM9SR | 135 | DEMM9PF179A | 138 | DEMNS9SNA197 | 7 |
| DEM-9S-NMB-76 | 195 | DEM9SS | 133 | DEMM9PG | 132 | DEMP5C1PJK87 | 44 |
| DEM-9S-NMB-76 | 195 | DEM9SW | 133 | DEMM9PH | 136 | DEMP5C1PVK87 | 50 |
| DEM-9S-NMC-77 | 195 | DEM9SX | 137 | DEMM9PK | 134 | DEMP5C1SJA197 | 45 |
| DEM5W1P1A0NNMBK52 | 195 | DEM9SZ | 137 | DEMM9PL | 132 | DEMP5C1SVA197 | 51 |
| DEM5W1P1A7NNMBK52 | 195 | DEMA15PNM | 184 | DEMM9PM | 136 | DEMP5HIPJK87 | 60 |
| DEM5W1P1A9NNMBK52 | 195 | DEMA15PNMBK47FO | 195 | DEMM9PP | 134 | DEMPSH1SJA197 | 61 |
| DEM5W1PF179ANMBK52 | 195 | DEMA15SNM | 185 | DEMM9PR | 134 | DEMP5P1PVK87 | 64 |
| DEM5W1PK87 | 78 | DEMA15SNMBK47FO | 195 | DEMM9PS | 132 | DEMP5P1SVA197 | 65 |
| DEM5W1PNM | 188 | DEMA25PNMBK47FO | 195 | DEMM9PW | 132 | DEMP9PJK87 | 16 |
| DEM5W1PNMBK52 | 195 | DEMA25SNMBK47FO | 195 | DEMM9PX | 136 | DEMP9SJA197 | 17 |
| DEM5W1POL3NMBK52 | 195 | DEMA37PNMBK47FO | 195 | DEMM9PZ | 136 | DEMP9PNMB77 | 195 |
| DEM5W1S1A0NNMBK52 | 195 | DEMA37SNMBK47FO | 195 | DEMM9S | 141 | DEMV5C1PNK87 | 52 |
| DEM5W1S1A7NNMBK52 | 195 | DEMA50PNMBK47FO | 195 | DEMM9SA | 133 | DEMV5C1PYK87 | 56 |
| DEM5W1S1A9NNMBK52 | 195 | DEMA50SNMBK47FO | 195 | DEMM9SB | 137 | DEMV5C1SNA197 | 53 |
| DEM5W1SA197 | 79 | DEMA9PNM | 182 | DEMM9SC | 135 | DEMV5C1SYA197 | 57 |
| DEM5W1SF179ANMBK52 | 195 | DEMA9PNMBK47FO | 195 | DEMM9SD | 133 | DEMV5HIPNK87 | 66 |
| DEM5W1SNM | 189 | DEMA9PNMBK52 | 195 | DEMM9SE | 137 | DEMV5HIPYK87 | 70 |
| DEM5W1SNMBK52 | 195 | DEMA9SNM | 183 | DEMM9SF | 135 | DEMV5H1SNA197 | 67 |
| DEM5W1SOL3NMBK52 | 195 | DEMA9SNMBK47FO | 195 | DEMM9SF179 | 139 | DEMV5H1SYA197 | 71 |
| DEM9P | 140 | DEMA9SNMBK52 | 195 | DEMM9SF179A | 139 | DEMVP9NK87 | 6 |
| DEM9P1A0NNMBK52 | 195 | DEMAK15PNMBK47FO | 195 | DEMM9SG | 133 | DEMVS9SNA197 | 7 |
| DEM9P1A7NNMBK52 | 195 | DEMAK15SNMBK47FO | 195 | DEMM9SH | 137 | DEMY5W1PK87 | 78 |
| DEM9P1A9NNMBK52 | 195 | DEMAK25PNMBK47FO | 195 | DEMM9SK | 135 | DEMY5W1PNM | 188 |
| DEM9PA | 132 | DEMAK25SNMBK47FO | 195 | DEMM9SL | 133 | DEMY5W1SA197 | 79 |
| DEM9PB | 136 | DEMAK37PNMBK47FO | 195 | DEMM9SM | 137 | DEMY5W1SNM | 189 |
| DEM9PC | 134 | DEMAK37SNMBK47FO | 195 | DEMM9SP | 135 | DEMY9P | 140 |
| DEM9PD | 132 | DEMAK50PNMBK47FO | 195 | DEMM9SR | 135 | DEMY9PNM | 180 |
| DEM9PE | 136 | DEMAK9PNMBK47FO | 195 | DEMM9SS | 133 | DEMY9PNM*1AON | 176 |
| DEM9PF | 134 | DEMAK9SNMBK47FO | 195 | DEMM9SW | 133 | DEMY9POL3NM | 172 |
| DEM9PF179 | 138 | DEMAY15PNM | 184 | DEMM9SX | 137 | DEMY9S | 141 |
| DEM9PF179A | 138 | DEMAY15SNM | 185 | DEMM9SZ | 137 | DEMY9SNM | 181 |
| DEM9PF179ANMBK52 | 195 | DEMAY9PNM | 182 | DEMMC5C1PJ | 146 | DEMY9SNM*1AON | 177 |
| DEM9PG | 132 | DEMAY9SNM | 183 | DEMMC5C1SJ | 147 | DEMYSOL3NM | 173 |
| DEM9PH | 136 | DEMB-5W1S-NMB-76 | 195 | DEMMC5H1PJ | 154 | DEMZ5C1PNK87 | 52 |
| DEM9PK | 134 | DEMB-9S-NMC-77 | 195 | DEMMC5H1SJ | 155 | DEMZ5C1PYK87 | 56 |
| DEM9PL | 132 | DEMB9S-NMB-76 | 195 | DEMD5C1PJ | 146 | DEMZ5C1SNA197 | 53 |
| DEM9PLNM | 174 | DEMB9S-NMC-76 | 195 | DEMD5C1SJ | 147 | DEMZ5C1SYA197 | 57 |
| DEM9PM | 136 | DEMB9SNMB77 | 195 | DEMD5H1PJ | 154 | DEMZ5HIPNK87 | 66 |
| DEM9PNM | 180 | DEMC5C1PJK87 | 44 | DEMD5H1SJ | 155 | DEMZ5HIPYK87 | 70 |
| DEM9PNM*1A7N | 178 | DEMC5C1PVK87 | 50 | DEMM5W1P | 166 | DEMZ5H1SNA197 | 67 |
| DEM9PNM*1A9N | 178 | DEMC5C1SJA197 | 45 | DEMM5W1S | 167 | DEMZ5H1SYA197 | 71 |
| DEM9PNM*1AON | 176 | DEMC5C1SVA197 | 51 | DEMM9P | 140 | DEMZ9PNK87 | 6 |
| DEM9PNMBK52 | 195 | DEMC5H1PJK87 | 60 | DEMM9S | 141 | DEMZ9SNA197 | 7 |
| DEM9PNMC76 | 195 | DEMC5H1SJA197 | 61 | DEMMG5C1PJ | 146 | DENG9P-P1 | 4 |
| DEM9PNMC77 | 195 | DEMC5P1PVK87 | 64 | DEMMG5C1SJ | 147 | DENGL9P-P1 | 5 |
| DEM9POL3NM | 172 | DEMC5P1SVA197 | 65 | DEMMG5H1PJ | 154 | DENGL9S-P1 | 5 |
| DEM9POL3NMBK52 | 195 | DEMC9SJA197 | 17 | DEMMG5H1SJ | 155 | DENGX9P-P1 | 4 |
| DEM9PP | 134 | DEMC9PJK87 | 16 | DEMMN5C1PN | 150 | DENGX9S-P1 | 5 |
| DEM9PR | 134 | DEMD5C1PJK87 | 44 | DEMMN5C1SN | 151 | DENGZ9P-P1 | 4 |
| DEM9PS | 132 | DEMD5C1PVK87 | 50 | DEMMN5H1PN | 158 | DENGZ9S-P1 | 5 |
| DEM9PW | 132 | DEMD5C1SJA197 | 45 | DEMMN5H1SN | 159 | DEW9P* | 38 |
| DEM9PX | 136 | DEMD5C1SVA197 | 51 | DEMMN5V1PN | 162 | DEW9P*G | 38 |
| DEM9PZ | 136 | DEMD5H1PJK87 | 60 | DEMMN5V1SN | 163 | DEW9S* | 39 |
| DEM9S | 141 | DEMD5H1SJA197 | 61 | DEMMMP5C1PJ | 146 | DEW9S*G | 39 |
| DEM9S1A0NNMBK52 | 195 | DEMD5P1PVK87 | 64 | DEMMMP5C1SJ | 147 | DEWE9P* | 38 |
| DEM9S1A7NNMBK52 | 195 | DEMD5P1SVA197 | 65 | DEMMMP5H1PJ | 154 | DEWE9P*G | 38 |
| DEM9S1A9NNMBK52 | 195 | DEMD9PJK87 | 16 | DEMMMP5H1SJ | 155 | DEWE9S* | 39 |
| DEM9SA | 133 | DEMD9SJA197 | 17 | DEMMV5C1PN | 150 | DEWE9S*G | 39 |
| DEM9SB | 137 | DEME5W1PK87 | 78 | DEMMV5C1SN | 151 | DEX9P-OL2-K87-146 | 10 |
| DEM9SC | 135 | DEME5W1SA197 | 79 | DEMMV5H1PN | 158 | DEX9PK87 | 32 |
| DEM9SD | 133 | DEME9P | 140 | DEMMV5H1SN | 159 | DEX9S-OL2-A197-146 | 11 |
| DEM9SE | 137 | DEME9S | 141 | DEMMV5V1PN | 162 | DEX9SA197 | 33 |
| DEM9SF | 135 | DEMG5C1PJK87 | 44 | DEMMV5V1SN | 163 | DM115224-1010A | 191, 195 |
| DEM9SF179 | 139 | DEMG5C1PVK87 | 50 | DEMMY5W1P | 166 | DM115224-1020A | 191, 195 |
| DEM9SF179A | 139 | DEMG5C1SJA197 | 45 | DEMMY5W1S | 167 | DM115224-1040A | 191, 195 |
| DEM9SF179ANMBK52 | 195 | DEMG5C1SVA197 | 51 | DEMMY9P | 140 | DM115224-2010A | 191, 195 |
| DEM9SG | 133 | DEMG5H1PJK87 | 60 | DEMMY9S | 141 | DM115224-2020A | 191, 195 |
| DEM9SH | 137 | DEMG5H1SJA197 | 61 | DEMMZ5C1PN | 150 | DM115224-2040A | 191, 195 |
| DEM9SK | 135 | DEMG5P1PVK87 | 64 | DEMMZ5C1SN | 151 | DM115224-3010 | 191, 195 |
| DEM9SL | 133 | DEMG5P1SVA197 | 65 | DEMMZ5H1PN | 158 | | |
| DEM9SLNM | 175 | DEMG9PJK87 | 16 | DEMMZ5H1SN | 159 | | |
| DEM9SM | 137 | DEMG9SJA197 | 17 | DEMMZ5V1PN | 162 | | |

D Subminiature

Part Number Index

| Part Number | Page | Part Number | Page | Part Number | Page | Part Number | Page |
|----------------|----------|--------------|---------|--------------------|---------|------------------|------|
| DM115224-3010A | 191 | DM51157-5000 | 91 | DM53743-19 | 87, 195 | MDSM-9SC-Z11-VS1 | 100 |
| DM115224-3020 | 191, 195 | DM51157-5005 | 91, 195 | DM53743-2 | 87 | ZDA15P-1AKN-146 | 28 |
| DM115224-3020A | 191 | DM51157-8 | 91, 195 | DM53743-3 | 87 | ZDA15P-A191 | 34 |
| DM115224-3040 | 191, 195 | DM53740 | 86 | DM53743-5 | 87 | ZDA15P-OL2 | 8 |
| DM115224-3040A | 191 | DM53740-1 | 86 | DM53743-5000 | 87 | ZDA15S-1AKN-146 | 29 |
| DM115224-4010 | 191, 195 | DM53740-15 | 86, 195 | DM53743-5001 | 87 | ZDA15S-A191 | 35 |
| DM115224-4010A | 191 | DM53740-16 | 86, 195 | DM53743-5003 | 87 | ZDA15S-OL2 | 9 |
| DM115224-4020 | 191, 195 | DM53740-17 | 86, 195 | DM53743-5004 | 87 | ZDAE15P-OL2-146 | 8 |
| DM115224-4020A | 191 | DM53740-18 | 86, 195 | DM53743-5073 | 87 | ZDAE15S-OL2-146 | 9 |
| DM115224-4040 | 191, 195 | DM53740-3 | 86 | DM53743-5074 | 87 | ZDAL15P-1AKN-146 | 28 |
| DM115224-4040A | 191 | DM53740-35 | 86 | DM53743-5076 | 87 | ZDAL15S-1AKN-146 | 29 |
| DM115740-12 | 195 | DM53740-36 | 190 | DM53743-5077 | 87 | ZDB25P-1AKN-146 | 28 |
| DM115740-13 | 195 | DM53740-5 | 86 | DM53743-6 | 87 | ZDB25P-A191 | 34 |
| DM115740-19 | 195 | DM53740-5000 | 86 | DM53744-1 | 90 | ZDB25P-OL2 | 8 |
| DM115740-5036 | 195 | DM53740-5001 | 86 | DM53744-107 | 93 | ZDB25S-1AKN-146 | 29 |
| DM115740-5046 | 195 | DM53740-5002 | 86 | DM53744-21 | 90, 191 | ZDB25S-A191 | 35 |
| DM115740-5047 | 195 | DM53740-5005 | 86 | DM53744-24 | 90, 191 | ZDB25S-OL2 | 9 |
| DM115741-5032 | 195 | DM53740-5008 | 86 | DM53744-25 | 90, 191 | ZDBE25P-OL2-146 | 8 |
| DM115741-5048 | 195 | DM53740-5099 | 86 | DM53744-6 | 90 | ZDBE25S-OL2-146 | 9 |
| DM115741-7 | 195 | DM53740-5100 | 86 | DM53744-62 | 191 | ZDBL25P-1AKN-146 | 28 |
| DM115741-8 | 195 | DM53740-5101 | 86 | DM53744-63 | 191 | ZDBL25S-1AKN-146 | 29 |
| DM115742-13 | 195 | DM53740-5104 | 86 | DM53744-64 | 191 | ZDC37P-1AKN-146 | 28 |
| DM115742-14 | 195 | DM53740-5105 | 86 | DM53744-7 | 90 | ZDC37P-A191 | 34 |
| DM115742-15 | 195 | DM53740-5145 | 86 | DM53744-92 | 93 | ZDC37P-OL2 | 8 |
| DM115742-5028 | 195 | DM53740-5147 | 190 | DM53744-95 | 93 | ZDC37S-1AKN-146 | 29 |
| DM115742-5039 | 195 | DM53741 | 87 | DM53745-1 | 90 | ZDC37S-A191 | 35 |
| DM115742-5075 | 195 | DM53741-1 | 87 | DM53745-104 | 93 | ZDC37S-OL2 | 9 |
| DM115743-20 | 195 | DM53741-10 | 87, 195 | DM53745-107 | 93 | ZDCE37P-OL2-146 | 8 |
| DM115743-22 | 195 | DM53741-11 | 87, 195 | DM53745-120 | 93 | ZDCE37S-OL2-146 | 9 |
| DM115743-5040 | 195 | DM53741-12 | 87, 195 | DM53745-126 | 95 | ZDCL37P-1AKN-146 | 28 |
| DM115743-5064 | 195 | DM53741-13 | 87, 195 | DM53745-25 | 90, 191 | ZDCL37S-1AKN-146 | 29 |
| DM130321-3 | 92 | DM53741-3 | 87 | DM53745-27 | 90, 191 | ZDD50P-A191 | 34 |
| DM130338 | 90 | DM53741-4 | 87 | DM53745-28 | 90, 191 | ZDD50P-OL2 | 8 |
| DM130338-1 | 90, 191 | DM53741-5000 | 87 | DM53745-7 | 90 | ZDD50S-A191 | 35 |
| DM130338-4 | 90 | DM53741-5001 | 87 | DM53745-70 | 191 | ZDD50S-OL2 | 9 |
| DM130339 | 90 | DM53741-5003 | 87 | DM53745-72 | 191 | ZDDE50P-OL2-146 | 8 |
| DM130339-1 | 90, 191 | DM53741-5004 | 87 | DM53745-77 | 191 | ZDDE50S-OL2-146 | 9 |
| DM130339-4 | 90 | DM53741-5059 | 87 | DM53745-8 | 90 | ZDE9P-1AKN-146 | 28 |
| DM130340 | 90 | DM53741-5060 | 87 | M24308/26-1 | 209 | ZDE9P-A191 | 34 |
| DM130340-1 | 90, 191 | DM53741-5062 | 87 | M24308/26-2 | 209 | ZDE9P-OL2 | 8 |
| DM130340-4 | 90 | DM53741-5063 | 87 | M85049/48-1-1 | 203 | ZDE9S-1AKN-146 | 29 |
| DM130341 | 90 | DM53742 | 86 | M85049/48-1-2 | 203 | ZDE9S-A191 | 35 |
| DM130341-1 | 90 | DM53742-1 | 86 | M85049/48-1-3 | 203 | ZDE9S-OL2 | 9 |
| DM130341-4 | 90 | DM53742-16 | 86, 195 | M85049/48-1-4 | 203 | ZDEE9P-OL2-146 | 8 |
| DM130342 | 90 | DM53742-17 | 86, 195 | M85049/48-1-5 | 203 | ZDEE9S-OL2-146 | 9 |
| DM130342-1 | 90 | DM53742-18 | 86, 195 | M85049/48-2-1 | 203 | ZDEL9P-1AKN-146 | 28 |
| DM130342-4 | 90 | DM53742-19 | 86, 195 | M85049/48-2-2 | 203 | ZDEL9S-1AKN-146 | 29 |
| DM130343 | 90 | DM53742-3 | 86 | M85049/48-2-3 | 203 | ZEDA15PBA | 18 |
| DM130343-1 | 90 | DM53742-36 | 86 | M85049/48-2-4 | 203 | ZEDA15SBA | 19 |
| DM130343-4 | 90 | DM53742-37 | 190 | M85049/48-2-5 | 203 | ZEDAL15PBA | 18 |
| DM130346-2 | 92 | DM53742-5 | 86 | M85049/48-3-2 | 204 | ZEDAL15SBA | 19 |
| DM130352-2 | 92 | DM53742-5000 | 86 | M85049/48-3-3 | 204 | ZEDB25PBA | 18 |
| DM130358-2 | 92 | DM53742-5001 | 86 | M85049/48-3-4 | 204 | ZEDB25SBA | 19 |
| DM13041-1 | 191 | DM53742-5002 | 86 | M85049/48-3-5 | 204 | ZEDBL25PBA | 18 |
| DM13042-1 | 191 | DM53742-5004 | 86 | M85049/50-1 | 204 | ZEDBL25SBA | 19 |
| DM13043-1 | 191 | DM53742-5006 | 86 | M85049/50-2 | 204 | ZEDC37PBA | 18 |
| DM51155 | 91 | DM53742-5085 | 86 | M85049/50-3 | 204 | ZEDC37SBA | 19 |
| DM51155-12 | 94 | DM53742-5086 | 86 | M85049/50-4 | 204 | ZEDCL37PBA | 18 |
| DM51155-13 | 94 | DM53742-5089 | 86 | M85049/50-5 | 204 | ZEDCL37SBA | 19 |
| DM51155-5000 | 91 | DM53742-5091 | 86 | MDSM-15PE-Z10-VR22 | 99 | ZEDE9PBA | 18 |
| DM51155-5004 | 91 | DM53742-5092 | 86 | MDSM-15SC-Z11-VS1 | 100 | ZEDE9SBA | 19 |
| DM51155-5005 | 195 | DM53742-5126 | 86 | MDSM-18PE-Z10-VR25 | 99 | ZEDL9PBA | 18 |
| DM51155-7 | 91, 195 | DM53742-5127 | 190 | MDSM-25PE-Z10-VR17 | 99 | ZEDL9SBA | 19 |
| DM51157 | 91 | DM53743-16 | 87, 195 | MDSM-25SC-Z11-VS1 | 100 | | |
| DM51157-13 | 94 | DM53743-17 | 87, 195 | MDSM-30PE-Z10-VR22 | 99 | | |
| DM51157-14 | 94 | DM53743-18 | 87, 195 | MDSM-9PE-Z10-VR25 | 99 | | |

Product Safety Information

THIS NOTE MUST BE READ IN CONJUNCTION WITH THE PRODUCT DATA SHEET/CATALOG. FAILURE TO OBSERVE THE ADVICE IN THIS INFORMATION SHEET AND THE OPERATING CONDITIONS SPECIFIED IN THE PRODUCT DATA SHEET/CATALOG COULD RESULT IN HAZARDOUS SITUATIONS.

1 MATERIAL CONTENT AND PHYSICAL FORM

Electrical connectors do not usually contain hazardous materials. They contain conducting and non-conducting materials and can be divided into two groups.

- a) Printed circuit types and low cost audio types which employ all plastic insulators and casings.
- b) Rugged, Fire Barrier and High Reliability types with metal casings and either natural rubber, synthetic rubber, plastic or glass insulating materials. Contact materials vary with type of connector and also application and are usually manufactured from either: Copper, copper alloys, nickel, alumel, chromel or steel. In special applications, other alloys may be specified.

2 FIRE CHARACTERISTICS AND ELECTRIC SHOCK HAZARD

There is no fire hazard when the connector is correctly wired and used within the specified parameters. Incorrect wiring or assembly of the connector or careless use of metal tools or conductive fluids, or transit damage to any of the component parts may cause electric shock or burns. Live circuits must not be broken by separating mated connectors as this may cause arcing, ionisation and burning. Heat dissipation is greater at maximum resistance in a circuit. Hot spots may occur when resistance is raised locally by damage, e.g. cracked or deformed contacts, broken strands of wire. Local overheating may also result from the use of the incorrect application tools or from poor quality soldering or slack screw terminals. Overheating may occur if the ratings in the product Data Sheet/Catalog are exceeded and can cause breakdown of insulation and hence electric shock.

If heating is allowed to continue it intensifies by further increasing the local resistance through loss of temper of spring contacts, formation of oxide film on contacts and wires and leakage currents through carbonisation of insulation and tracking paths. Fire can then result in the presence of combustible materials and this may release noxious fumes. Overheating may not be visually apparent. Burns may result from touching overheated components.

3 HANDLING

Care must be taken to avoid damage to any component parts of electrical connectors during installation and use. Although there are normally no sharp edges, care must be taken when handling certain components to avoid injury to fingers.

Electrical connectors may be damaged in transit to the customers, and damage may result in creation of hazards. Products should therefore be examined prior to installation/use and rejected if found to be damaged.

4 DISPOSAL

Incineration of certain materials may release noxious or even toxic fumes.

5 APPLICATION

Connectors with exposed contacts should not be selected for use on the current supply side of an electrical circuit, because an electric shock could result from touching exposed contacts on an unmated connector. Voltages in excess of 30 V ac or 42.5 V dc are potentially hazardous and care should be taken to ensure that such voltages cannot be transmitted in any way to exposed metal parts of the connector body. The connector and wiring should be checked, before making live, to have no damage to metal parts or insulators, no solder blobs, loose strands, conducting lubricants, swarf, or any other undesired conducting particles. Circuit resistance and continuity check should be made to make certain that there are no high resistance joints or spurious conducting paths. Always use the correct application tools as specified in the Data Sheet/Catalog.

Do not permit untrained personnel to wire, assemble or tamper with connectors. For operation voltage please see appropriate national regulations.

IMPORTANT GENERAL INFORMATION

(i) Air and creepage paths/Operating voltage
The admissible operating voltages depend on the individual applications and the valid national and other applicable safety regulations.

For this reason the air and creepage path data are only reference values. Observe reduction of air and creepage paths due to PC board and/or harnessing.

(ii) Temperature

All information given are temperature limits. The operation temperature depends on the individual application.

(iii) Other important information

ITT Cannon continuously endeavours to improve their products. Therefore, ITT Cannon products may deviate from the description, technical data and shape as shown in this catalog and data sheets.

ITT Cannon manufactures the highest quality products available in the marketplace; however these products are intended to be used in accordance with the specifications in this publication. Any use or application that deviates from the stated operating specifications is not recommended and may be unsafe. No information and data contained in this publication shall be construed to create any liability on the part of ITT Cannon. Any new issue of this publication shall automatically invalidate and supersede any and all previous issues. A limited warranty applies to ITT Cannon products. Except for obligations assumed by ITT Cannon under this warranty, ITT Cannon shall not be liable for any loss, damage, cost of repairs, incidental or consequential damages of any kind, whether or not based on express or implied warranty, contract, negligence or strict liability arising in connection with the design, manufacture, sale, use or repair of the products. Product availability, prices and delivery dates are exclusively subject to our respective order confirmation form; the same applies to orders based on development samples delivered. This publication is not to be construed as an offer. It is intended merely as an invitation to make an offer. By this publication, ITT Cannon does not assume responsibility or any liability for any patent infringements or other rights of third parties which may result from its use. Reprinting this publication is generally permitted, indicating the source. However, ITT Cannon's prior consent must be obtained in all cases.

WE'RE PART OF YOUR WORLD
IN INTERCONNECT TECHNOLOGY



APR
+27
NRNG
17 db
SCU76
EPTH
32 MM
OWER
100%
FPS
14
REJECT
1
EDGE
1
GREY
3
SMOOTH
2
ALPHA *
NAME ALANA
10

We are focused on your world with Innovation, Experience, Reliability & Responsiveness.

Don't blink.

No industry in the world moves faster than electronics. Take a snapshot of it today, and it all changes by tomorrow.

When you need to bring your products to market more quickly, you most likely seek a partner who moves just as fast as you do. A company at the forefront with the latest in products and service.

At ITT Cannon, we have made it our business to understand your world. Or should we say, the many parts of your world:

The places in the world where you do business.

The products you bring to the world.

The service you require from suppliers to compete in the world.

At ITT Cannon, we are proud of a heritage that helped pioneer the electronics industry from its infancy in the early part of this century, to the highly advanced technologies of the present.

Today, we serve nearly every industry in which the increased demand for reliable and innovative interconnect systems is critical:

Computers (Personal computers, portables and peripherals)

Telecommunications (Network systems and services/LAN; mobile)

Transportation (Automobiles, heavy-duty vehicles, rail and mass transit)

Military/Aerospace (Commercial and military aircraft, defense and space)

Industrial (Factory automation and instrumentation)

Medical (Diagnostic equipment)

Broadcasting

Consumer Products

As ITT Cannon begins our ninth decade in business, we are proud to provide our global and regional customers with the most reliable electronic products and services available:

Interconnects and cable assemblies

RF connectors

Switches and conductive rubber switchpads

Test accessories

I/O card, memory card and smart card interconnects

Local area network components (copper and fiber optic)

Turn-key network systems and services

Customer use tooling

I N N O V A T I O N

A commitment to concurrent engineering helps you reach your markets faster

Let us bring our spirit of innovation to your world. Experienced engineering teams located throughout the globe work hand-in-hand with our customers. And since these teams are thoroughly networked together, you benefit from 24 hour-a-day concurrent engineering capability. These teams advance your project from initial product concepts to final design and into production.

Our teams are experts in computer-based design, modeling and analysis to assure robust product designs. We are also well-versed in performance simulation, as well as verification of mechanical and electrical properties. ITT Cannon utilizes Pro/ENGINEER* software which allows us to develop products and manufacturing processes concurrently, and to easily evaluate multiple design alternatives. This means better designed products, produced faster and at a lower cost.

ITT Cannon's Integrated Product Development process (IPD) allows us to minimize cycle time for first article and volume production.

*A trademark of Parametric Technology Corp.

E X P E R I E N C E

Worldwide capacity to meet all of your delivery requirements

Our decades of manufacturing experience, help us bring the latest products to your world. With automated manufacturing capacity strategically located in North America, Europe and Asia, we can produce products in either large or small quantities to quickly meet your exact requirements.

ITT Cannon is able to modify existing products to suit special customer requirements. With global manufacturing capacity in every continent, we are also able to source product from the location that best suits your needs. This means we have the flexibility to select the most advantageous shipping methods and other logistical options.

ITT Cannon has established Centers of Excellence for world class capabilities such as: Machining, stamping, surface plating, molding, cable assembly and network systems technology — all utilizing the most advanced CAM equipment.

R E L I A B I L I T Y

We don't stop at "world class quality" — Continuous improvement is our standard

Our goal is to bring world class electronics to your world. This commitment to perfection has helped ITT Cannon's global facilities earn ISO 9000 certification. We have invested in world class process controls for both assembly and component manufacturing.

ITT Cannon has also met or exceeded the quality system requirements from all customers who have conducted audits. We participate in ship-to-stock programs with many of these customers worldwide and have received numerous quality and preferred supplier awards from customers throughout the world in each of the industries we serve.

R E S P O N S I V E N E S S

A singular focus on responding to your needs

We know that to be responsive, we must know your world inside and out: your particular company, your industry and your challenges. Each of ITT Cannon's thousands of employees worldwide is focused on responding to you with timely and dependable information — and on ensuring that we keep the commitments we make. For instance, our globally linked computer system tracks the status of your order anywhere in the world.

You also benefit from our field applications and sales network, which provides industry-specific knowledge to help you design in the best product for your application.

Our distribution network is one of the most extensive in the industry, and can provide you off-the-shelf product to meet the most challenging delivery requirements.

A N I N V I T A T I O N

T O S H A R E
Y O U R W O R L D

Innovation. Experience. Reliability. Responsiveness.

At ITT Cannon, these are the strengths that we bring to our customers each and every day. Just as we have for nearly nine decades. We pride ourselves on a level of service and manufacturing know-how that has enabled us to lead our industry. Exceeding your expectations — not just meeting them — is how we approach every project.

With the world moving faster all the time, ITT Cannon is a partner who can help you get your products to market not just on time, but ahead of the competition.

At ITT Cannon, we realize that each customer we serve has their own special needs and expectations. That is why we would welcome the opportunity to discuss your project, your company, your industry — yes, your world.

Mouser Electronics

Authorized Distributor

Click to View Pricing, Inventory, Delivery & Lifecycle Information:

[ITT Cannon:](#)

[D110280](#) [980-2000-945](#) [D20419](#) [D20420](#) [M85049/48-2-5F](#) [D110550](#) [D53018](#) [DM53742-5006](#) [DM51155-7](#)
[DLM2-96R](#) [DBA-25S-A197-F0](#) [250-8501-010](#) [250-8501-004](#) [D110277](#) [D110278](#) [D2042013](#) [D110551](#) [DA-60-20BA](#)
[DA-59-20BA](#) [D110279](#) [DA512201](#) [DCM-37S](#) [DEMM-9P](#) [DEMM-9S](#) [DEM-9P](#) [DAM-15P](#) [DCMM-37P](#) [DEM-9S](#)
[M85049/48-1-8F](#) [M85049/48-1-3F](#) [M85049/48-1-4F](#) [M85049/48-1-1F](#) [M85049/48-1-5F](#) [DAM-15S](#) [DBMM-25S-Z](#)
[DBMM-25S-P](#) [DBMM-25S-F](#) [DBMM-25S-F179](#) [DBMM-25S](#) [DBMM-25S-E](#) [DCM-37P](#) [DAMM-15P](#) [DBM-25P-G](#)
[DBM-25P-M](#) [DBM-25P-P-NMBK52](#) [DBM-25P](#) [DBM-25P-D](#) [DBM-25P-E](#) [DBM-25P-A](#) [DDM-50S](#) [DC121073152](#) [DE-](#)
[59-20BA](#) [DE-60-20BA](#) [DB121073151](#) [DC512221](#) [DE121073154](#) [M24308/24-35F](#) [DE11533920](#) [DAMM-15S](#) [DBM-](#)
[25S-H](#) [DBM-25S](#) [DBM-25S-D-NMBK52](#) [DBM-25S-0L3-NMBK52](#) [DBM-25S-S](#) [DBM-25S-F179](#) [DBM-25S-D](#) [DBM-](#)
[25S-Z](#) [DBM-25S-L](#) [DBM-25S-E](#) [DBM-25S-W](#) [DBM-25S-N-K126](#) [DBM-25S-K126](#) [DBMM-25P](#) [DBMM-25P-F179](#)
[DBMM-25P-B](#) [DBMM-25P-A-A159](#) [DBMM-25P-F179A](#) [DBMM-25P-E](#) [DCMM-37S](#) [M2430813F](#) [M243082433F](#)
[M24308125Z](#) [M2430834F](#) [M2430835F](#) [M243082425F](#) [M24308123F](#) [M2430814Z](#) [M2430832F](#) [M24308124F](#)
[M24308232F](#) [M24308126F](#) [M243082431F](#) [M24308241F](#) [M2430831F](#) [M24308123Z](#) [M2430812Z](#) [M2430811F](#)
[M24308231F](#) [M24308243F](#) [M243082432F](#)