

WRA_ZP-3W & WRB_ZP-3W Series 3W, WIDE INPUT, ISOLATED & REGULATED DUAL/SINGLE OUTPUT, DC-DC CONVERTER



Patent Protection RoHS

PART NUMBER SYSTEM

WRB0512ZP-3W

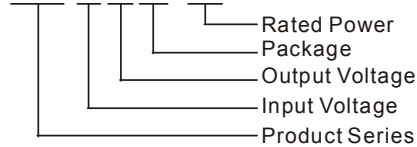

FEATURES

- 2:1 wide input range
- Operating temperature range: -40°C ~ +85°C
- Short circuit protection
- 1.5KVDC isolation
- UL94-V0 package
- No external component required
- MTBF>1,000,000 hours
- Five sides metal shielding

APPLICATIONS

The WRA_ZP-3W & WRB_ZP-3W series are designed for applications where the output power is directly introduced into the power control circuit board After the AC / DC converter filter circuit from a distributed power system. For these DC-DC converters, You can reduce the design point of failure and save the development of micro power supply's manpower, material and time costs, also better ensure product quality stability, protect safety and reliability of the end of products.

These products apply to where:

- 1) Input voltage ranges ≤ 2:1;
- 2) 1.5KVDC input and output isolation;
- 3) Regulated and low ripple noise are required.

SELECTION GUIDE

Model	Input Voltage(VDC)		Output Voltage (VDC)	Output Current (mA)		Input Current (mA)(typ.)		Reflected Ripple Current (mA,typ.)	Max. Capacitive Load# (μF)	Efficiency (% ,typ.) @Max. Load						
	Nominal (Range)	Max*		Max.	Min.	@Max. Load	@No Load									
WRA0505ZP-3W	5 (4.5-9)	11	±5	±300	±30	882	60	25	680	68						
WRA0512ZP-3W			±12	±125	±12	833										
WRA0515ZP-3W			±15	±100	±10	822										
WRB0505ZP-3W			5	600	60	882										
WRB0509ZP-3W			9	333	33	857										
WRB0512ZP-3W			12	250	25	833										
WRB0515ZP-3W			15	200	20	822										
WRB0524ZP-3W			24	125	12	800										
WRA1205ZP-3W			12 (9-18)	22	±5	±300					±30	338	30	25	680	74
WRA1212ZP-3W	±12	±125			±12	320										
WRA1215ZP-3W	±15	±100			±10	316										
WRB1203ZP-3W	3.3	909			90	347										
WRB1205ZP-3W	5	600			60	338										
WRB1212ZP-3W	12	250			25	320										
WRB1215ZP-3W	15	200			20	325										
WRA2405ZP-3W	24 (18-36)	40			±5	±300	±30	162	10	30	680	77				
WRA2412ZP-3W					±12	±125	±12	158								
WRA2415ZP-3W			±15	±100	±10	156										
WRB2403ZP-3W			3.3	909	90	169										
WRB2405ZP-3W			5	600	60	162										
WRB2412ZP-3W			12	250	25	158										
WRB2415ZP-3W			15	200	20	156										
WRB2424ZP-3W			24	125	12	156										
WRA4805ZP-3W			48 (36-72)	80	±5	±300	±30	81					8	30	680	77
WRA4812ZP-3W	±12	±125			±12	79										
WRA4815ZP-3W	±15	±100			±10	78										
WRA4824ZP-3W	±24	±62			±6	77										
WRB4803ZP-3W	3.3	909			90	84										
WRB4805ZP-3W	5	600			60	81										
WRB4812ZP-3W	12	250			25	79										
WRB4815ZP-3W	15	200			20	78										

Note: 1. Models listed with strike-through text have been officially discontinued.
2. *Input voltage can't exceed this value, or will cause the permanent damage.
3. # For each output.

INPUT SPECIFICATIONS

Item	Test Conditions	Min.	Typ.	Max.	Unit
Input Surge Voltage (1sec. max.)	5VDC Input Models	-0.7	--	12	VDC
	12VDC Input Models	-0.7	--	25	
	24VDC Input Models	-0.7	--	50	
	48VDC Input Models	-0.7	--	100	
Start-up Voltage	5VDC Input Models	--	4	4.5	
	12VDC Input Models	--	8	9	
	24VDC Input Models	--	17	18	
	48VDC Input Models	--	33	36	
Short Circuit Input Power		--	--	2.5	W
Input Filter		LC Filter			

OUTPUT SPECIFICATIONS

Item	Test Conditions	Min.	Typ.	Max.	Unit
Output Power		0.3	--	3	W
Positive voltage accuracy	Refer to recommended circuit	--	±1	±3	%
Negative voltage accuracy		--	±3	±5	
Output Voltage Balance	Dual Output, Balanced Loads	--	±0.5	±1	
Line Regulation	Full load, Input voltage from low to high	--	±0.2	±0.5	
Load Regulation	10% to 100% load	--	±0.5	±1	
Transient Recovery Time	25%~ 50%~25% load or	--	6	20	ms
Transient Response Deviation	50%~75%~50% load step change	--	±3	±5	%
Temperature Drift	100% load	--	--	±0.03	%/°C
Ripple & Noise*	20MHz Bandwidth	--	50	200	mVp-p
Short Circuit Protection		Continuous			

Note: 1. Dual output models unbalanced load: ±5%.
2.* Ripple and noise tested with "parallel cable" method. See detailed operation instructions at *DC-DC application notes*.

COMMON SPECIFICATIONS

Item	Test Conditions	Min.	Typ.	Max.	Unit
Isolation Voltage	Tested for 1 minute and leakage current less than 1 mA	1500	--	--	VDC
Isolation Resistance	Test at 500VDC	1000	--	--	MΩ
Isolation Capacitance	Input/Output, 100KHz/1V	--	85	--	pF
Switching Frequency	Full load, nominal input	--	300	--	KHz
MTBF	MIL-HDBK-217F@25°C	1000	--	--	K hours
Case Material		Aluminum Alloy			
Weight		--	13	--	g

ENVIRONMENTAL SPECIFICATIONS

Item	Test Conditions	Min.	Typ.	Max.	Unit
Storage Humidity	Non condensing	--	--	95	%
Operating Temperature	Power derating (above 71°C)	-40	--	85	°C
Storage Temperature		-55	--	125	
Temp. rise at full load	Ta=25°C	--	15	--	
Lead Temperature	1.5mm from case for 10 seconds	--	--	300	
Cooling		Free air convection			

EMC SPECIFICATIONS

EMI	CE	CISPR22/EN55022 CLASS A (External Circuit Refer to Figure1-②)			
	RE	CISPR22/EN55022 CLASS A (External Circuit Refer to Figure1-②)			
EMS	ESD	IEC/EN61000-4-2 Contact ±4KV perf. Criteria B			
	EFT	IEC/EN61000-4-4 ±2KV perf. Criteria B (External Circuit Refer to Figure 1-①)			
	Surge	IEC/EN61000-4-5 ±2KV perf. Criteria B (External Circuit Refer to Figure 1-①)			

EMC RECOMMENDED CIRCUIT

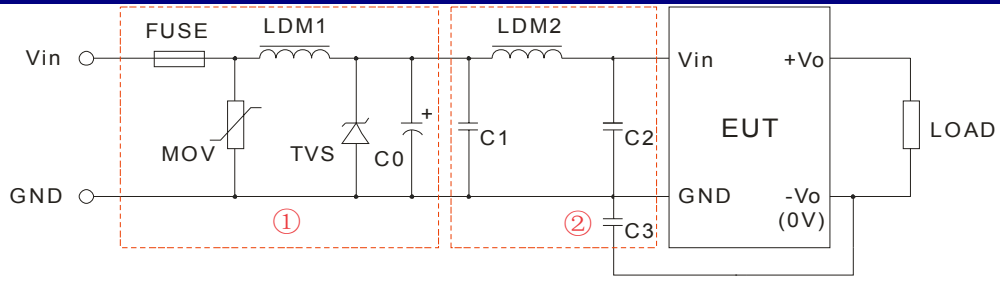

(Figure1)

WRA_ZP-3W recommended external circuit parameters:

Model		Vin: 5V	Vin: 12V	Vin: 24V	Vin: 48V
EMS	FUSE	Choose according to practical input current			
	MOV	--	--	S10K35	S10K60
	LDM1	--	--	56μH	56μH
	TVS	SMCJ13A	SMCJ28A	SMCJ48A	SMCJ90A
	C0	680μF/16V	680μF/25V	120μF/50V	120μF/100V
EMI	C1	4.7μF/50V			4.7μF/100V
	C3	1000pF/2KV			

WRB_ZP-3W recommended external circuit parameters:

Model		Vin: 5V	Vin: 12V	Vin: 24V	Vin: 48V
EMS	FUSE	Choose according to practical input current			
	MOV	--	--	S10K35	S10K60
	LDM1	--	--	56μH	56μH
	TVS	SMCJ13A	SMCJ28A	SMCJ48A	SMCJ90A
	C0	680μF/16V	680μF/25V	120μF/50V	120μF/100V
EMI	C1	2.2μF/50V			4.7μF/100V
	LDM2	12μH			
	C2	1μF/50V			1μF/100V
	C3	100pF/2KV			

Note: 1. In Figure 1, part ① is EMS Recommended external circuit, part ② is EMI recommended external circuit. Choose according to requirements.
2. If there is no recommended parameters, the model no require the external component.

EMC RECOMMENDED CIRCUIT PCB LAYOUT

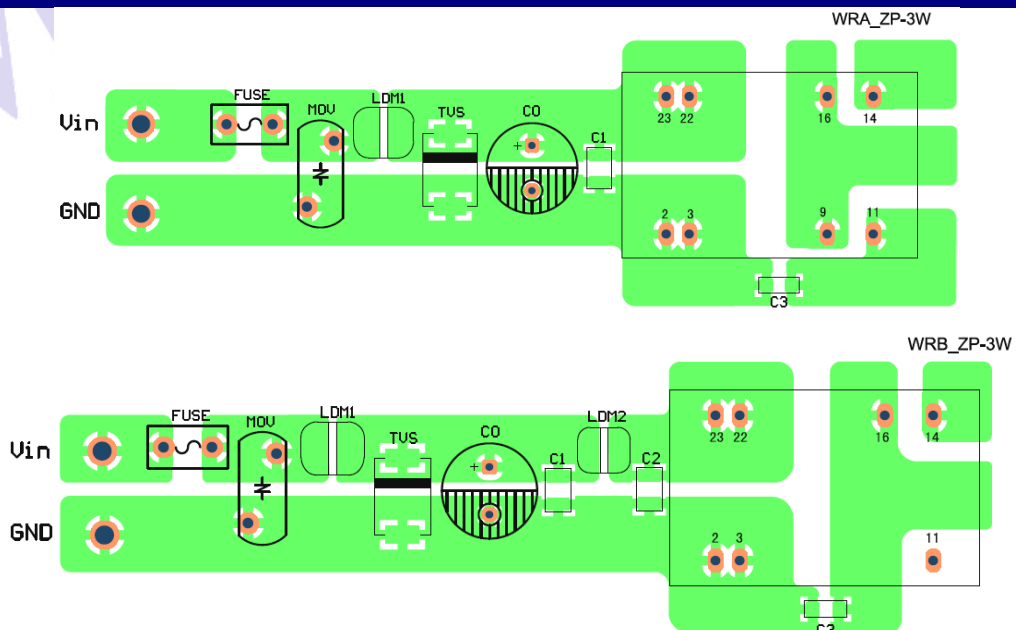

(Figure 2)

PRODUCT TYPICAL CURVE

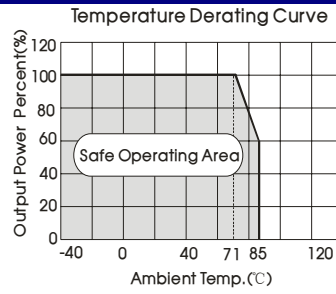

Efficiency VS Input Voltage curve (Full Load)

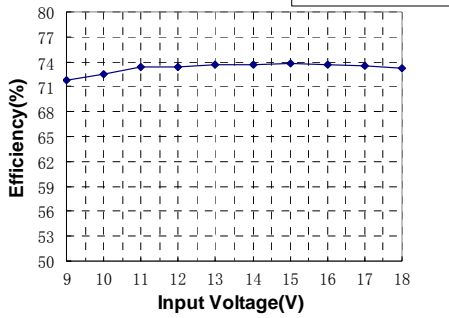

Efficiency VS Input Voltage curve (Full Load)

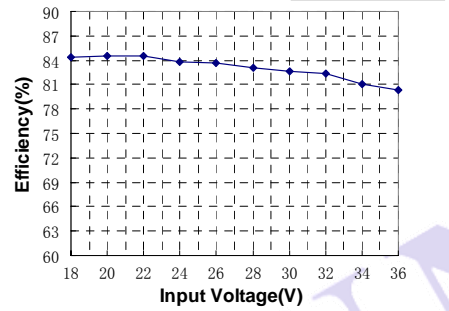

Efficiency VS Output Load curve (Vin=Vin-nominal)

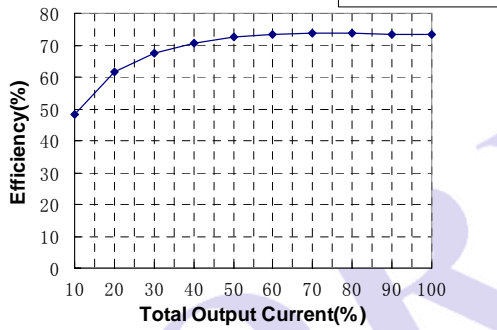

Efficiency VS Output Load curve (Vin=Vin-nominal)

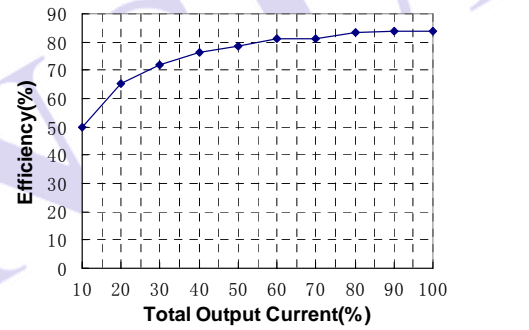

OUTLINE DIMENSIONS, RECOMMENDED FOOTPRINT & PACKAGING

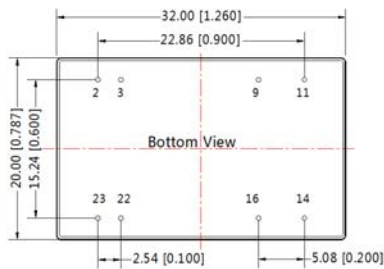
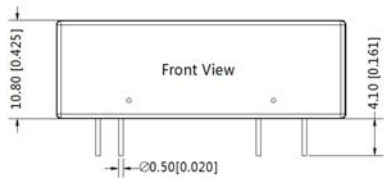

Note:
Unit :mm[inch]
Pin diameter tolerances :±0.10[±0.004]
General tolerances:±0.50[±0.020]

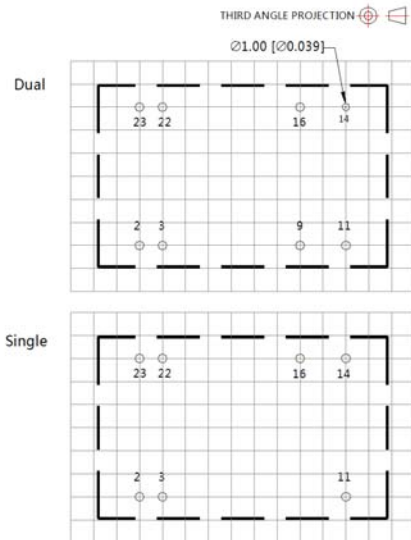

Pin	Pin-Out	
	Single	Dual
2,3	GND	GND
9	No Pin	0V
11	NC	-Vo
14	+Vo	+Vo
16	0V	0V
22,23	Vin	Vin

NC: No Connection

TEST CONFIGURATIONS

Input Reflected-Ripple Current Test Setup

Input reflected-ripple current is measured with an inductor L_{in} and Capacitor C_{in} to simulate source impedance.

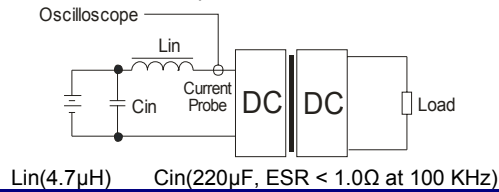

DESIGN CONSIDERATIONS

1) Requirement on output load

To ensure this module can operate efficiently and reliably, During operation, the minimum output load **could not be less than 10% of the full load**. If the actual output power is very small, please connect a resistor with proper resistance at the output end in parallel to increase the load, or use our company's products with a lower rated output power.

2) Overload Protection

Under normal operating conditions, the output circuit of these products has no protection against overload. The simplest method is add a circuit breaker to the circuit.

3) Recommended circuit

All the WRA_ZP-3W & WRB_ZP-3W Series have been tested according to the following recommended testing circuit before leaving factory(Figure 3).

If you want to further decrease the input/output ripple, you can increase a capacitance properly or choose capacitors with low ESR. However, the capacitance of the output filter capacitor must be proper. If the capacitance is too big, a startup problem might arise. For every channel of output, provided the safe and reliable operation is ensured, the greatest capacitance of its filter capacitor must less than the Max. Capacitive Load.

General: C_{in} : 5V&12V 100µF
24V&48V 10µF~47µF
 C_{out} : 10µF/100mA

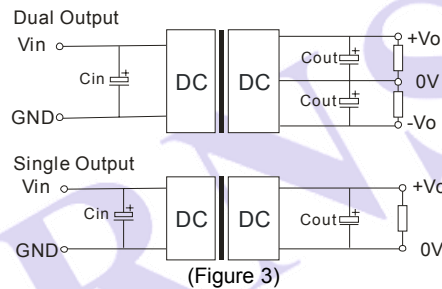

4) Input current

Nominal input voltage range. The input current of the power supply must be sufficient to the startup current (I_p) of the DC/DC module(Figure 4).

General: $I_p \leq 1.4 * I_{in-max}$

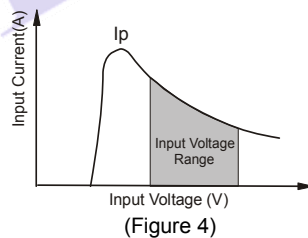

5) Cannot use in parallel and hot swap

Note:

1. Operation under minimum load will not damage the converter; However, they may not meet all specification listed.
2. Max. Capacitive Load tested at input voltage range and full load.
3. All specifications measured at $T_a=25^\circ\text{C}$, humidity<75%, nominal input voltage and rated output load unless otherwise specified.
4. In this datasheet, all the test methods of indications are based on our corporate standards.
5. All characteristics are for listed model only, non-standard models may perform differently, please contact our technical person for more detail.
6. Contact us for your specific requirement.
7. Specifications subject to change without prior notice.

MORNSUN Science & Technology Co.,Ltd.

Address: No. 5, Kehui St. 1, Kehui development center, Science Ave., Guangzhou Science City, Luogang district, Guangzhou, P.R.China.

Tel: 86-20-38601850

Fax: 86-20-38601272

E-mail: info@mornsun.cn

Http://www.mornsun-power.com